

Generic Design Assessment – New Civil Reactor Build

**Step 4 Civil Engineering and External Hazards Assessment of the Westinghouse
AP1000[®] Reactor**

Assessment Report: ONR-GDA-AR-11-002
Revision 0
11 November 2011

COPYRIGHT

© Crown copyright 2011

First published December 2011

You may reuse this information (excluding logos) free of charge in any format or medium, under the terms of the Open Government Licence. To view the licence visit www.nationalarchives.gov.uk/doc/open-government-licence/, write to the Information Policy Team, The National Archives, Kew, London TW9 4DU, or email psi@nationalarchives.gsi.gov.uk.

Some images and illustrations may not be owned by the Crown so cannot be reproduced without permission of the copyright owner. Enquiries should be sent to copyright@hse.gsi.gov.uk.

Unless otherwise stated, all corporate names, logos, and Registered® and Trademark™ products mentioned in this Web site belong to one or more of the respective Companies or their respective licensors. They may not be used or reproduced in any manner without the prior written agreement of the owner(s).

For published documents, the electronic copy on the ONR website remains the most current publically available version and copying or printing renders this document uncontrolled.

PREFACE

The Office for Nuclear Regulation (ONR) was created on 1st April 2011 as an Agency of the Health and Safety Executive (HSE). It was formed from HSE's Nuclear Directorate (ND) and has the same role. Any references in this document to the Nuclear Directorate (ND) or the Nuclear Installations Inspectorate (NII) should be taken as references to ONR.

The assessments supporting this report, undertaken as part of our Generic Design Assessment (GDA) process, and the submissions made by Westinghouse relating to the AP1000[®] reactor design, were established prior to the events at Fukushima, Japan. Therefore, this report makes no reference to Fukushima in any of its findings or conclusions. However, ONR has raised a GDA Issue which requires Westinghouse to demonstrate how they will be taking account of the lessons learnt from the events at Fukushima, including those lessons and recommendations that are identified in the ONR Chief Inspector's interim and final reports. The details of this GDA Issue can be found on the Joint Regulators' new build website www.hse.gov.uk/newreactors and in ONR's Step 4 Cross-cutting Topics Assessment of the AP1000[®] reactor.

EXECUTIVE SUMMARY

This report presents the findings of the Civil Engineering and External Hazards assessment of the AP1000 reactor undertaken as part of Step 4 of the Health and Safety Executive's (HSE) Generic Design Assessment (GDA). The assessment has been carried out by HSE's Nuclear Directorate based on the Pre-construction Safety Report and supporting documentation submitted by Westinghouse Electric Company LLC.

This assessment has followed a step-wise-approach in a claims-argument-evidence hierarchy. In Step 2 the claims made by Westinghouse were examined, in Step 3 the arguments that underpin those claims were examined.

The scope of the Step 4 assessment was to review the safety aspects of the AP1000 reactor in greater detail, by examining the evidence, supporting arguments and claims made in the safety documentation, building on the assessments already carried out for Steps 2 and 3, and to make a judgement on the adequacy of the Civil Engineering and External Hazards information contained within the Pre-construction Safety Report (PCSR) and supporting documentation.

It is seldom possible, or necessary, to assess a safety case in its entirety, therefore sampling is used to limit the areas scrutinised, and to improve the overall efficiency of the assessment process. Sampling is done in a focused, targeted and structured manner with a view to revealing any topic-specific, or generic, weaknesses in the safety case. To identify the sampling for the Civil Engineering and External Hazards an assessment plan for Step 4 was set-out in advance. This plan was modified to account for emergent factors during the process of the Step 4 assessment.

My assessment has focused on:

- The design and construction of the novel, steel-concrete-steel, composite sandwich, modular construction proposed for the in-containment structures and for the spent fuel pool area of the Auxiliary Building. This was the subject of the Regulatory Issue raised at the end of Step 3 (RI-AP1000-002).
- The design and construction of the novel steel-concrete-steel modular construction proposed for the Enhanced Shield Building circular wall. This was also included in RI-AP1000-002.
- Metrication of the AP1000 design when used in the UK.
- Materials specified the AP1000 design and their applicability in the UK.
- The Spent Fuel Pool liner, containment barriers and leak detection systems.
- Safety categorisation and classification of civil structures.
- External Hazards claims and dependencies. The compilation of the external hazards that need to be considered in the generic design, and confirming those which can only be finalised at site specific design phase.
- Justification of the Category I structures with respect to withstand against impact arising from aircraft crash or other malicious activity. My assessment is summarised in this report, since the detail is covered in a separate report.
- The development of the load schedule to be applied to civil structures resulting from external hazards.
- Load schedule application in the design.

- The seismic design methodology and finite element modelling used for the civil design of the nuclear island Category I structures.
- The interaction of Category III and Category II structures with Category I structures, as well as each other, in order to ensure the Category I structures are not adversely affected.
- Review of application of design and construction codes and standards and industry good practice in the design of the Category I, II and III civil structures.
- Deep sample assessment of a selected sample of individual civil structures as follows:
 - Shield Building roof, including PCS Tank and shield plate
 - nuclear island foundation slab
 - specific parts of the in-containment modules.
 - specific parts of the Auxiliary Building
 - the Turbine Building split categorisation of first bay and the rest of the building
 - Seismic isolation of buildings
- Use of superseded codes and standards.
- Review of seismic margins and fragilities calculated by Westinghouse for a sample of civil structures.
- Audit of the reliability of application of design criteria from basis documents and cited codes and standards through to point of application in the design calculations.
- Control of design quality with respect to Westinghouse's use of civil design sub-consultants or "design partners"; how they are instructed and how their work is checked and approved.

The Radwaste Building is considered to be outside the scope of the GDA process for the topic of civil engineering and external hazards, since the building layout is to be modified to accommodate the operational space required on each site. There is no effect on any of the other GDA structures.

From my assessment, I have concluded that:

In some areas there has been a lack of detailed information which has limited the extent of my assessment. For areas which cannot be completed until nearer to the start of construction, e.g. those that require input from the contractor, the outstanding items have been identified as Assessment Findings to be carried forward as normal regulatory business. These are listed in Annex 1. Those areas which depend on site specific data before they can be completed have also been listed as Assessment Findings in Annex 1.

Some of the observations identified within this report are of particular significance and will require resolution before HSE ND would agree to the commencement of nuclear safety related construction of an AP1000 reactor in the UK. These are identified in this report as GDA Issues and are formally defined in Annex 2 of this report. In summary these relate to:

GI-AP1000-CE-01: *Justification of novel form of structure for the steel/concrete composite walls and floors known as CA Modules.*

GI-AP1000-CE-02: *Further justification of novel form of structure for the steel/concrete composite wall to the Enhanced Shield Building.*

GI-AP1000-CE-03: *Materials – AP1000 material standards and material specifications.*

GI-AP1000-CE-04: *Fuel handling area – secondary containment leak detection and collection system for Spent Fuel Pool.*

In addition to the civil engineering GDA Issues above, cross-cutting issues have been raised which are relevant to civil engineering as follows:

GI-AP1000-CC-01: *Operational limits and conditions derived from the safety case.*

GI-AP1000-CC-02: *Configuration control of PCSR and Safety Submission Documentation to Support GDA.*

GI-AP1000-CC-03: *Consider and action plans to address the lessons learnt from the Fukushima event.*

GI-AP1000-ME-02: *Metrication of Mechanical Equipment and Civil Structural Steelwork Connections.*

During the course of my assessment, I have liaised with Inspectors of other topic areas. Where GDA issues have been raised in these areas, which could affect the civil design, I have referred to them in my report. These GDA issues are as follows:

GI-AP1000-IH-01: *Fire Barriers with specific reference to performance of SC construction.*

GI-AP1000-IH.02: *Internal flooding.*

GI-AP1000-IH.03: *Pressure part failure.*

GI-AP1000-IH.04: *Internal explosion.*

GI-AP1000-IH-05: *Internal Missiles.*

GI-AP1000-IH-06: *Dropped loads and impacts.*

GI-AP1000-EE-01: *Substantiate the design of the complete Plant Electrical Distribution System, specifically the capability to withstand the loss of the two Standby Diesel Generators.*

The complete GDA Issues and associated actions are formally defined in Annex 2 of the appropriate topic area reports.

Overall, based on the sample undertaken in accordance with ONR procedures, I am broadly satisfied that the claims, arguments and evidence laid down within the PCSR and supporting documentation submitted as part of the GDA process present an adequate safety case for the generic AP1000 reactor design. The AP1000 reactor is therefore suitable for construction in the UK, subject to satisfactory progression and resolution of GDA Issues to be addressed during the forward programme for this reactor and assessment of additional information that becomes available as the GDA Design Reference is supplemented with additional details on a site-by-site basis.

LIST OF ABBREVIATIONS

AASHTO	Association of State Highway and Transportation Officials
ABSC	ABS Consulting Ltd
ACI	American Concrete Institute
ADS	Automatic Depressurisation System
AF	Assessment Finding
AISC	American Institute of Steel Construction
ALARP	As Low As Reasonably Practicable
ALWR	Advanced Light Water Reactor (ALWR)
Amec	Amec Nuclear UK Ltd
ANSI	American National Standards Institute
Arup	Arup & Partners Ltd
ASB	Auxiliary Shield Building, i.e. collective term for Auxiliary Building and the Shield Building
ASD	Allowable Stress Design
ASTM	American Standard for Testing and Materials
AWS	American Welding Society
BAT	Best Available Techniques
BMS	(Nuclear Directorate) Business Management System
BSi	British Standards Institute
BSL	Basic Safety Level (in SAPs)
BSO	Basic Safety Objective (in SAPs)
CA	CA (Civil A) Modules are the prefabricated structural modules used for the in containment structures and within the Auxiliary Building. These comprise steel/concrete composite or steel only modules used for walls and floors.
CB/CS	Further types of modular construction: The CB (Civil B) Modules are prefabricated form modules used as permanent formwork to concrete pours. The CS (Civil stair) Modules are steel staircases
CCB	Change Control Board
CDFM	Conservative Deterministic Failure Margin
CDM2007	Construction (Design and Management) Regulations 2007
CIS	Containment Internal Structures
CLDP1	Contaminated Land Developed Principle Number 1
CSDRS	Certified Seismic Design Response Spectrum

LIST OF ABBREVIATIONS

CV	Containment Vessel
DBA	Design Basis Accident
DCD	Design Control Document
DGP	Design Change Proposal
DECC	Department of Energy and Climate Change
DfT	Department for Transport
DSF	Document Submittal Form
EDCD	European Design Control Document
EHTR	External Hazards Topic Report
EMI	Electro-magnetic interference
ESB	Enhanced Shield Building
FE	Finite Element
GDA	Generic Design Assessment
HCLPF	High Confidence of Low Probability of Failure
HSC	Half steel concrete
HSE	The Health and Safety Executive
HVAC	Heating, Ventilation, Air Conditioning
IAEA	The International Atomic Energy Agency
IBC	International Building Code
IRWST	In-containment Refuelling Water Storage Tank
KOPEC	Korea Power Engineering Company, Ltd.
LC28	Site License Condition 28
LRFD	Load and Resistance Factor Design
MCR	Main control room
MDEP	Multinational Design Evaluation Programme
NCB	Non-classified Building
ND	The (HSE) Nuclear Directorate
NDA	Nuclear Decommissioning Authority
NI	Nuclear Island
NNS	Non-nuclear Seismic Class
NPP	Nuclear Power Plants
OCNS	Office for Civil Nuclear Security
OJEU	Official Journal of the European Union

LIST OF ABBREVIATIONS

OOP	Out-of-plane
PCER	Pre-construction Environment Report
PCS	Passive Cooling System
PCSR	Pre-construction Safety Report
PGA	Peak ground acceleration
PID	Project Initiation Document
PML	Principica Mechanica Ltd
POSR	Pre-operational safety report
PSA	Probabilistic Safety Analysis
PSR	Preliminary Safety Report
QA	Quality Assurance
QMS	Quality Management System
QSL	Qualified Suppliers List
RC	Reinforced Concrete
RG	Regulatory Guide (US NRC)
RGP	Relevant Good Practice
RI	Regulatory Issue
RIA	Regulatory Issue Action
RO	Regulatory Observation
ROA	Regulatory Observation Action
RS	Response Spectra
SAP	Safety Assessment Principles
SASSI	System Analysis of Soil-Structure Interaction (numerical analysis program by ACS Ltd)
SSI	Soil Structure Interaction
SC	steel-concrete composite construction, i.e. walls – steel-concrete-steel sandwich construction floors – concrete cast on steel composite floors
SCAR	Supplier Corrective Action Report
SCC	self-consolidating concrete
SFAIRP	So Far As Is Reasonably Practicable
SFP	Spent Fuel Pool
SFS	Spent Fuel Cooling System
SQEP	Suitably Qualified and Experience Person
SSC	System, Structure and Component

LIST OF ABBREVIATIONS

SSE	Safe Shutdown Earthquake
SSER	Safety, Security and Environmental Report
SSI	Soil Structure Interaction
TAG	(Nuclear Directorate) Technical Assessment Guide
TIG	Nuclear Directorate) Technical Inspection Guide
TQ	Technical Query
TSC	Technical Support Contractor
UHS	Uniform Hazard Spectra
US NRC	Nuclear Regulatory Commission (United States of America)
WAF	Work Authorisation Form
WEC	Westinghouse Electric Company LLC
WENRA	The Western European Nuclear Regulators' Association

TABLE OF CONTENTS

1	INTRODUCTION.....	1
2	NUCLEAR DIRECTORATE'S ASSESSMENT STRATEGY FOR CIVIL ENGINEERING AND EXTERNAL HAZARDS	2
2.1	Overall Strategy	2
2.2	Assessment Plan	3
2.3	Standards and Criteria	3
2.3.1	HSE ND Business Management System	3
2.3.2	HSE ND Safety Assessment Principles.....	4
2.3.3	HSE ND Technical Assessment Guides.....	5
2.3.4	International Guidance.....	5
2.3.5	US Nuclear Regulator.....	6
2.4	Assessment Scope	6
2.4.1	Findings from GDA Step 3.....	6
	2.4.1.1 Primary Conclusions.....	6
	2.4.1.2 Remaining Conclusions.....	7
2.4.2	Additional Areas for Step 4 Civil Engineering and External Hazards Assessment	8
2.4.3	Use of Technical Support Contractors.....	10
	2.4.3.1 ABS Consulting.....	10
	2.4.3.2 Amec Nuclear UK Ltd	10
	2.4.3.3 Ove Arup & Partners Ltd	11
2.4.4	Integration with other Assessment Topics.....	11
2.4.5	Cross-cutting Topics	11
2.4.6	Out of Scope Items	12
3	WESTINGHOUSE'S SAFETY CASE.....	14
3.1	Safety Case Documentation	14
3.1.1	Pre-construction Safety Report	14
	3.1.1.1 Background.....	14
	3.1.1.2 Relevant Chapters	14
3.1.2	European DCD	15
	3.1.2.1 Background.....	15
	3.1.2.2 Relevant Sections.....	16
3.1.3	Primary Supporting Documents.....	16
	3.1.3.1 Supporting Documents to PCSR.....	16
3.2	Description of the Generic Site	19
3.3	Building Layouts.....	21
3.3.1	Foundations	21
3.3.2	Containment Vessel.....	21
3.3.3	Containment Internal Structures.....	23
3.3.4	Shield Building	23
3.3.5	Auxiliary Building	25
3.3.6	Annex Building.....	26
3.3.7	Diesel Generator Building.....	26

3.3.8	Radwaste Building	26
3.3.9	Turbine Building	27
3.4	Civil Structures Safety Functions	27
3.4.1	Overall.....	27
3.4.2	Nuclear Island.....	27
3.4.3	Ancillary Buildings.....	29
3.5	Categorisation and Classification.....	29
3.5.1	Introduction	29
3.5.2	Categorisation.....	30
3.5.3	Classification.....	30
3.5.4	Classification of Buildings for Seismic Hazard	31
	3.5.4.1 Methodology	31
	3.5.4.2 Seismic Classification of Safety Related Systems	31
3.6	Design Standards	32
4	GDA STEP 4 NUCLEAR DIRECTORATE ASSESSMENT FOR CIVIL ENGINEERING AND EXTERNAL HAZARDS	34
4.1	Safety Case Documentation	34
4.1.1	Pre-construction Safety Report	34
4.1.2	European DCD	34
4.1.3	Supporting Documents	34
4.2	Classification and Categorisation.....	34
4.2.1	Assessment	34
4.2.2	Split Seismic Classification for Turbine Building and Annex Building	35
4.2.3	NNS Classification of the Radwaste Building	35
4.2.4	Summary and Findings.....	36
4.3	Design Codes	36
4.3.1	AP1000 Codes and Standards	36
	4.3.1.1 Assessment	36
	4.3.1.2 Findings	38
4.3.2	Use of Superseded Codes and Standards	38
	4.3.2.1 Assessment	38
	4.3.2.2 Summary and Findings.....	40
4.4	External Hazards	41
4.4.1	Introduction	41
4.4.2	Assessment Approach.....	42
4.4.3	Documentation.....	43
4.4.4	Site Parameters	43
4.4.5	External Hazard Selection and Screening Methodology	44
4.4.6	Hazards Subjected to Westinghouse Detailed Review	46
	4.4.6.1 Introduction	46
	4.4.6.2 Earthquake	46
	4.4.6.3 External Flooding.....	47
	4.4.6.4 Aircraft Crash.....	47
	4.4.6.5 External Explosion.....	47
	4.4.6.6 Extreme Ambient Temperatures.....	47
	4.4.6.7 Meteorology	48

4.4.6.8	Wind.....	48
4.4.6.9	Climate Change.....	48
4.4.6.10	Offsite Fire and Smoke.....	48
4.4.6.11	Offsite Missiles.....	48
4.4.6.12	Biological Fouling.....	48
4.4.6.13	Electromagnetic Interference (EMI) and Lightning.....	48
4.4.7	Load Schedule Application.....	49
4.4.8	Summary and Findings.....	49
4.5	Internal Hazards.....	50
4.5.1	Assessment.....	50
4.5.2	Findings.....	51
4.6	Aircraft Impact Protection.....	51
4.6.1	Scope.....	51
4.6.2	Assessment.....	52
4.6.3	Findings.....	53
4.7	Materials.....	53
4.7.1	Assessment.....	53
4.7.1.1	General.....	53
4.7.1.2	Material Substitution.....	55
4.7.1.3	Steel Plate.....	55
4.7.1.4	Concrete.....	56
4.7.1.5	Steel Reinforcing Bar.....	57
4.7.1.6	Geotechnical Specifications.....	57
4.7.2	Summary and Findings.....	58
4.7.2.1	General.....	58
4.7.2.2	Material Substitution.....	58
4.7.2.3	Material Equivalence to EN Standards.....	58
4.7.2.4	Concrete Mix Design and Testing.....	59
4.7.2.5	Steel Reinforcement.....	59
4.7.2.6	Geotechnical Specifications.....	59
4.8	Metrication.....	60
4.8.1	Introduction.....	60
4.8.2	Assessment.....	60
4.8.2.1	Assessment Progress.....	60
4.8.2.2	Building Structures Generally.....	61
4.8.2.3	Steelwork Connections.....	61
4.8.2.4	Steelwork Generally.....	62
4.8.2.5	Reinforcement Steel.....	62
4.8.3	Findings.....	63
4.9	FE Analyses.....	64
4.9.1	Introduction.....	64
4.9.2	Documentation.....	64
4.9.3	FE Analyses and Codes Used.....	64
4.9.4	Assessment.....	66
4.9.5	Findings.....	67
4.10	Seismic Design Methodology.....	67
4.10.1	Assessment Objectives.....	67
4.10.2	Documentation.....	68

4.10.3	Seismic Design Criteria	68
	4.10.3.1 Seismic Class I	69
	4.10.3.2 Seismic Class II	69
	4.10.3.3 Seismic Class NNS.....	70
	4.10.3.4 Findings	70
4.10.4	Seismic Analysis Methodologies	71
	4.10.4.1 Assessment	71
	4.10.4.2 Soil Structure Interaction Analyses (SSI)	71
	4.10.4.3 Findings	72
4.10.5	AP1000 Generic Ground Motion	72
	4.10.5.1 Definition of Hard Rock.....	72
	4.10.5.2 Generic Spectra.....	72
	4.10.5.3 Input Motion to SSI Analyses	73
	4.10.5.4 Findings	74
4.10.6	Floor Response Spectra	75
	4.10.6.1 Assessment	75
4.10.7	Accuracy of Seismic FE Model.....	76
	4.10.7.1 Mesh Size	76
	4.10.7.2 Soil Impedance.....	76
	4.10.7.3 Time Step Verification	77
	4.10.7.4 Frequency Time Step Verification	77
	4.10.7.5 Findings	78
4.10.8	Seismic Interaction of NI with Other Buildings.....	78
	4.10.8.1 Acceptance Criteria	78
	4.10.8.2 Interaction Analyses	78
	4.10.8.3 Interaction of Radwaste Building with Auxiliary Building.....	80
	4.10.8.4 Interaction of NNS Turbine Building with C-II First Bay.....	80
	4.10.8.5 Findings	82
4.11	Nuclear Island Foundation and Basement.....	83
4.11.1	Design of Raft Foundation.....	83
	4.11.1.1 Assessment	83
	4.11.1.2 Summary and Findings.....	84
4.11.2	Sliding, Overturning and Uplift.....	84
	4.11.2.1 Assessment	84
	4.11.2.2 Summary and Findings.....	85
4.11.3	Settlement during Construction	86
	4.11.3.1 Assessment	86
	4.11.3.2 Summary and Findings.....	87
4.11.4	Waterproofing	87
	4.11.4.1 Assessment	87
	4.11.4.2 Summary and Findings.....	88
4.11.5	Ground Water	88
	4.11.5.1 Assessment	88
	4.11.5.2 Summary and Findings.....	88
4.11.6	Backfill.....	89
	4.11.6.1 Assessment	89
	4.11.6.2 Summary and Findings.....	89
4.12	Containment Vessel.....	89
4.12.1	Assessment	89

4.12.2	Findings	91
4.13	Containment Internal Structures	92
4.13.1	Introduction	92
4.13.2	Assessment of SC Design Methodology	92
4.13.3	Load Schedule Application to CA Modules	93
4.13.3.1	Introduction	93
4.13.3.2	Loads	93
4.13.3.3	Thermal Loads.....	95
4.13.3.4	Hydrodynamic Loads.....	95
4.13.3.5	Load Combinations.....	95
4.13.4	Deep Sample of Hydrodynamic Load on IRWST	97
4.13.5	Findings	97
4.14	Enhanced Shield Building	97
4.14.1	Description of Structure	97
4.14.2	Assessment Process	99
4.14.3	RC Cylindrical Wall	99
4.14.4	Roof	100
4.14.4.1	Assessment	100
4.14.4.2	Findings	100
4.14.5	Tension Ring.....	101
4.14.5.1	Assessment	101
4.14.5.2	Findings	101
4.14.6	Compression Ring	101
4.14.6.1	Assessment	101
4.14.6.2	Findings	102
4.14.7	PCS Water Tank.....	102
4.14.7.1	Assessment	102
4.14.7.2	Summary and Findings.....	102
4.14.8	Shield Plate.....	103
4.14.8.1	Assessment	103
4.14.8.2	Findings	104
4.15	Auxiliary Building.....	104
4.15.1	Introduction	104
4.15.2	Load Schedule Application	105
4.15.2.1	Introduction	105
4.15.2.2	Loads from External hazards.....	106
4.15.2.3	Loads from Internal Hazards	107
4.15.2.4	Load Combinations.....	107
4.15.3	Deep Sample of Wall 7.3.....	108
4.15.3.1	Introduction	108
4.15.3.2	Loads for Wall 7.3.....	108
4.15.3.3	Load Combinations for Wall 7.3	108
4.15.3.4	Methodology of Wall 7.3 Deep Sample	109
4.15.4	Deep Sample of Auxiliary Building Roof.....	109
4.15.4.1	Introduction	109
4.15.4.2	Loads for Auxiliary Roof, Area 3.....	110
4.15.4.3	Snow Drift Load	111
4.15.5	Deep Sample of CA20 within Auxiliary Building	111

4.15.5.1	Introduction	111
4.15.5.2	Loads and Load Combinations.....	111
4.15.5.3	Deep Sample of Load Combination 03	113
4.15.6	Summary and Findings.....	114
4.16	SC Modular Construction.....	114
4.16.1	Introduction	114
4.16.2	Assessment Progress.....	115
4.16.3	Documents Submitted	118
4.16.4	Structural Arrangement of SC Walls.....	119
4.16.5	Structural Arrangement of SC Floors/Slabs	122
4.16.6	Design Methodology for SC Structures	123
4.16.6.1	Background.....	123
4.16.6.2	CA Modules	123
4.16.6.3	ESB SC Wall.....	124
4.16.6.4	Benchmark Testing.....	124
4.16.7	Assessment of CA Modules.....	125
4.16.7.1	Design Provisions	125
4.16.7.1.1	Assessment	125
4.16.7.1.2	Findings on Design.....	129
4.16.7.2	Construction Provisions.....	133
4.16.7.2.1	Assessment	133
4.16.7.2.2	Findings for Construction Provisions.....	134
4.16.8	Assessment of ESB SC Cylindrical Wall	134
4.16.8.1	Design Provisions	134
4.16.8.1.1	Assessment	134
4.16.8.1.2	Summary and Findings.....	137
4.16.8.2	Connections.....	140
4.16.8.2.1	Assessment	140
4.16.8.2.2	Findings on Connections	141
4.16.8.3	Construction Provisions.....	141
4.16.8.3.1	Assessment	141
4.16.8.3.2	Findings	141
4.16.9	Floor Modules	142
4.16.9.1	Assessment	142
4.16.9.2	Summary and Findings.....	142
4.16.10	Summary and Findings.....	143
4.16.10.1	Summary on CA Modules.....	143
4.16.10.2	Summary on ESB SC wall	144
4.16.10.3	Summary on SC Floors	145
4.17	Spent Fuel Pool Liner	145
4.17.1	Introduction	145
4.17.2	Documents Submitted	145
4.17.3	Containment Requirements	146
4.17.4	Assessment Aims	146
4.17.5	Description of SFP	147
4.17.5.1	General Arrangement	147
4.17.5.2	Operation	147
4.17.5.3	Structural Arrangement	148
4.17.5.4	Design Basis.....	149
4.17.5.5	Containment Provided/Claimed.....	149

4.17.6	Assessment	150
	4.17.6.1 Possible Leak Paths and Consequences	150
	4.17.6.2 Liner Integrity	151
	4.17.6.3 Dropped Loads	151
	4.17.6.4 Repair of Leaks.....	151
4.17.7	Summary and Findings.....	151
4.18	Turbine Building	152
	4.18.1 Assessment	152
	4.18.2 Loads and Load Combinations.....	153
	4.18.3 Seismic Isolation.....	154
	4.18.3.1 Assessment	154
	4.18.3.2 Gap 1 - Between First Bay and Auxiliary Building.....	154
	4.18.3.3 Gap 2 – Between C-II and NNS parts of Turbine Building	154
	4.18.4 Findings	155
4.19	Annex Building	155
	4.19.1 Assessment	155
	4.19.2 Findings	156
4.20	Diesel Generator Building.....	156
	4.20.1 Assessment	156
	4.20.2 Findings	156
4.21	Radwaste Building	157
4.22	Sample of Seismic Margins and Fragilities	157
	4.22.1 Scope of Assessment.....	157
	4.22.2 Assessment	157
	4.22.2.1 Methodologies	157
	4.22.2.2 ESB SC Cylindrical Wall.....	158
	4.22.2.3 ESB RC Cylindrical Wall.....	158
	4.22.2.4 CIS and IRWST Tank	159
	4.22.3 Summary and Findings.....	159
	4.22.3.1 Methodologies	159
	4.22.3.2 ESB SC Cylindrical Wall.....	159
	4.22.3.3 ESB RC Cylindrical Wall.....	160
	4.22.3.4 CIS and IRWST Tank	160
4.23	Quality Assurance of Civil Design.....	160
	4.23.1 Scope of Assessment.....	160
	4.23.2 Westinghouse Quality Management System.....	161
	4.23.3 External Organisations	162
	4.23.4 Design Change	163
	4.23.5 Sub-Contractor Audits	164
	4.23.6 Findings	165
4.24	Construction Verification	165
4.25	Operational Inspection and Maintenance	166
4.26	Decommissioning.....	166
	4.26.1 Assessment	166
	4.26.2 Findings	167
4.27	Overseas Regulatory Interface	168

4.28	Interface with Other Regulators	168
4.28.1	Environment Agency.....	168
4.29	Other Health and Safety Legislation	169
4.29.1	The Construction (Design and Management) Regulations 2007	169
5	CONCLUSIONS.....	171
5.1	Key Findings from the Step 4 Assessment.....	171
5.1.1	Civil Engineering and External Hazards.....	171
5.1.2	Assessment Findings.....	172
5.1.3	GDA Issues.....	173
6	REFERENCES.....	174

Tables

Table 1:	Relevant Safety Assessment Principles for Civil Engineering and External Hazards considered during Step 4
Table 2:	Step 4 Assessment Plan
Table 3:	Step 4 Assessment Topic Areas
Table 4:	PCSR Chapters Relevant to ONR-GDA-AR-11-002
Table 5:	Primary References for Civil Engineering and External Hazards
Table 6:	AP1000 UK Categorisation and Classification of Structures
Table 7:	AP1000 Codes and Standards
Table 8:	Superseded Standards
Table 9:	AP1000 Bounding Site Parameters
Table 10:	AP1000 Materials
Table 11:	FE Models used for AP1000
Table 12:	AP1000 Seismic Design Criteria
Table 13:	Relative Displacements of Adjacent Buildings
Table 14:	Seismic Design Methodology for Turbine Building
Table 15:	Factors of Safety for Floatation, Sliding and Overturning
Table 16:	Load Combinations and Load Factors - CIS Concrete Structures
Table 17:	Load Combinations and Load Factors - CIS Steel Structures
Table 18:	Load Combinations for Auxiliary Building
Table 19:	Load Combinations Applied to Wall 7.3
Table 20:	Load Combinations for CA20 Modules
Table 21:	Assessment Timeline for SC Construction Assessment
Table 22:	Westinghouse Claimed Measures for Reliability for CA Modules
Table 23:	HCLPF Values Calculated by Westinghouse
Table 24:	Westinghouse External Organisations: Scope of Supply and Status

Annexes

Annex 1: Assessment Findings to be Addressed During the Forward Programme as Normal Regulatory Business - Civil Engineering and External Hazards – AP1000

Annex 2: GDA Issues – Civil Engineering and External Hazards – AP1000

Figures

Figure 1: Generic Site Plan.....	19
Figure 2: General View of AP1000 Plant	20
Figure 3: Cut View of AP1000 Plant	22
Figure 4: Typical Section Through Shield Building	24
Figure 5: Comparison between AP1000 Spectrum and the UK PML Spectra.....	73
Figure 6: Seismic Ground Motions.....	74
Figure 7: The FE Mesh of the Excavated Soil in the NI-20 SASSI Model.....	77
Figure 8: Nuclear Island and Adjacent Structures (Figure A-1 of Ref. 141).....	79
Figure 9: Comparison of Spectra for two parts of Turbine Building	81
Figure 10: Typical Section Through Shield Building	98
Figure 11: Areas 3&4 at Elevation 160'-6" (Figure 1-1 of APP-1260-CCC-002).....	110
Figure 12: Arrangement of Steel Plates, Shear Studs and Steel Trusses for CA Modules	120
Figure 13: Arrangement of Steel Plates, Tie Bars and Shear Studs for ESB	120
Figure 14: Plan on CA20 Showing Spent Fuel Pool	147
Figure 15: Section Through CA20 Showing Spent Fuel Pool	148

1 INTRODUCTION

- 1 This report presents the findings of the Step 4 Civil Engineering and External Hazards assessment of the AP1000 reactor PCSR (Ref. 1) and supporting documentation provided by Westinghouse Electric Company LLC (Westinghouse) under the Health and Safety Executive's (HSE) Generic Design Assessment (GDA) process. Assessment was undertaken of the PCSR and the supporting evidentiary information derived from the Master Submission List (Ref. 2). The approach taken was to assess the principal submission, i.e. the PCSR, and then undertake assessment of the relevant documentation sourced from the Master Submission List on a sampling basis in accordance with the requirements of ONR Business Management System (BMS) procedure AST/001 (Ref. 3). The Safety Assessment Principles (SAP) (Ref. 4) have been used as the basis for this assessment. Ultimately, the goal of assessment is to reach an independent and informed judgment on the adequacy of a nuclear safety case.
- 2 During the Step 4 GDA assessment, 128 Technical Queries (TQ), three Regulatory Observations (RO) and one Regulatory Issue (RI) were issued under the civil engineering and external hazards topic. The schedules of all TQs, ROs and RIs raised during Step 4 are given in references Ref. 5, 6 and 7 respectively. The responses made by Westinghouse to these documents has supplemented the submission documents and in some cases resulted in modifications to the safety case.
- 3 The HSE's Guide to Requesting Parties (Ref. 8) defines the planned scope of GDA. Westinghouse has confirmed in its letter UN REG WEC 000512 (Ref. 9) that there will be some out of scope items. The items which affect the civil engineering assessment are the exclusion of the Radwaste Building, the procurement of long lead items and final arrangement of decontamination facilities.
- 4 The Safety Assessment Principles (Ref. 4), which are of most relevance to the assessment of civil engineering and external hazards aspects of the AP1000, are presented in Table 1 at the back of this report. The most significant SAPs are repeated again in the text where relevant to the subject being discussed.

2 NUCLEAR DIRECTORATE'S ASSESSMENT STRATEGY FOR CIVIL ENGINEERING AND EXTERNAL HAZARDS

2.1 Overall Strategy

5 A proposal to licence new nuclear power stations in the UK is subjected to a two phase process as detailed in the Generic Design Assessment (GDA) – Guidance to Requesting Parties document (Ref. 8). Phase 1 consists of four steps with the aim of assessing the structures, systems and components of the generic design, i.e. those that will be common to all AP1000 sites. Phase 2 is concerned with site specific aspects for the actual site that has been proposed, and confirms whether a site specific license can be granted.

6 This assessment report covers the civil engineering and external hazards assessment carried out in Phase 1, Step 4. The four steps of Phase 1 are as follows:

- Step 1 (Q1 to Q3 2007) was the preparatory design assessment process during which there were discussions to establish a full understanding of the requirements and processes that would be applied.
- Step 2 (Q3 2007 to Q2 2008) was an overview of the fundamental acceptability of the proposed reactor design concept within the UK regulatory regime. Step 2 examined the claims made to identify any aspects that could prevent the proposed design from being licensed in the UK.
- Step 3 (Q2 2008 to Q4 2009) examined the arguments given for the claims made under Step 2. A generic safety case was provided to the HSE ND and an environment report to the Environment Agency detailing the safety and environment aspects of the proposed reactor design. The general intention was to move from the fundamentals of the previous step to an analysis of the design, primarily by examination at the system level and by analysis of the supporting arguments.
- Step 4 (Q1 2010 to Q2 2011) is an in-depth assessment by the HSE ND of the safety case and generic site envelope submitted. The general intention of this step is to move from the system-level assessment of Step 3 to a fully detailed examination of the evidence, on a sampling basis, given by the safety analyses.

7 During Step 4, the evidence was examined to a greater depth, by selecting certain buildings or structures to sample in detail and check the high level claims were carried through in the detailed design process.

8 The basis of my Step 4 assessment is Westinghouse's Pre-construction Safety Report (PCSR), UKP-GW-GL-732 Revision 2, (Ref. 10) submitted at the end of Step 3 in December 2009 (refer to 3.1.1.1). However, I take due cognisance of the fact that throughout Step 4, Westinghouse aimed to improve the PCSR in response to the concerns raised by ONR in Step 3. A reworked version was submitted in draft on 16 December 2010 (UKP-GW-GL-793 Revision A, (Ref. 1), which intended to incorporate all the claims and arguments for the safety case that had been discussed with ONR throughout Step 4.

9 In this Step 4 assessment report I have concentrated on the primary supporting documents which detail the claims made on the various structures. The claims made in the two versions of the PCSR are not markedly different, but the 2010 PCSR contains much more information. Hence the strategy described in the Step 4 assessment plan would not require to be re-adjusted as a result of the 2010 PCSR submission.

10 Westinghouse plans to issue a consolidated, generic PCSR at the end of GDA to incorporate all appropriate comments and feedback from ONR and potential licensees, as

well as from its own technical design development. Any changes to the PCSR will need to be assessed by HSE ND to confirm that it matches the GDA conclusions.

2.2 Assessment Plan

- 11 The intended assessment strategy for Step 4 for the Civil Engineering and External Hazards topic area was set out in an assessment plan (Ref. 11) that identified the intended scope of the assessment and the standards and criteria that would be applied. This is summarised below.
- 12 The Step 4 Assessment Plan (Ref. 11) states that *“It is seldom possible or necessary to assess a safety case in its entirety. Sampling is used to limit the areas scrutinised, to limit the total effort to be applied, and to improve the overall efficiency of the assessment process. If sampling is done in a focused, targeted and structured manner it can be expected to reveal generic weaknesses in the safety case as a whole. The majority of samples are drawn from areas of high safety relevance since weaknesses in these areas are potentially very serious, but a few should also be taken from lower significance areas to check for possible omissions within the safety case.”*
- 13 The Step 4 plan was drafted at the end of Step 3 (December 2009), and was targeted at continuing the investigation into the concerns raised during Step 3 (refer to Section 2.4.1 of this report). The areas initially identified for further assessment in the Step 4 plan are presented in Table 2 in Section 2.4.2.
- 14 The scope of the Step 4 assessment is described below in Section 2.4. This summarises the scope of the assessment work that has been carried out based on the initial intent of the Step 4 plan, and how questions that emerged during the course of Step 4 were addressed.

2.3 Standards and Criteria

2.3.1 HSE ND Business Management System

- 15 The Business Management System (BMS) sets out the procedures, instructions and guidance to ONR Inspectors in carrying out their assessment. The BMS comprises the four key business activities: permission inspection, compliance inspection, standards and advice and research. GDA is carried out in accordance with the procedures for permission inspection.
- 16 This assessment has been carried out in line with the requirements of the following key BMS procedures:
- AST/001 Assessment Process (Ref. 3)
 - AST/003 Technical Reports (Ref. 12)
- 17 AST/001 outlines ONR's ways of dealing with assessment of duty holder's submissions leading to judgements about adequacy and reporting the outcomes.
- 18 The ONR policy for assessment is stated in paragraphs 2.1 to 2.3 of AST/001 as follows.
- *“Inspectors will assess and inspect on a sample basis involving others such as consultants and other regulators where appropriate. Sampling is based on professional judgemental to establish and maintain regulatory confidence in the adequacy of safety.”*

- *Inspectors will apply their judgement based on their knowledge and experience in the application of relevant safety law, HSE's Safety Assessment Principles (SAPs), Technical Assessment and Inspection Guides (TAGs and TIGs) and other relevant good safety practice.*
- *Where appropriate, Inspectors should also take account of relevant regulatory activities internationally – much regulatory good practice may be found in IAEA documents.”*

19 AST/001 states that the assessment should be based on relevant good practice, other standards and criteria that can be used for evaluation. These may include:

- licence conditions and other relevant law;
- SAPs, supported by TAGs and TIGs;
- licensee's own standards and criteria;
- engineering codes;
- national / international standards (notably IAEA guidance);
- international regulatory practice;
- learning from other high hazard industries;
- other accepted relevant good practice.

2.3.2 HSE ND Safety Assessment Principles

20 This assessment has been carried out with the aid of a number of applicable Safety Assessment Principles (SAP) which are principles against which regulatory judgements are made. The SAPs provide fundamental guidance in scoping an assessment topic and in carrying out an effective assessment. This approach ensures the assessment provides a targeted, proportionate, consistent and transparent consideration on the adequacy of the Westinghouse design.

21 The SAPs (Ref. 4) apply to the assessment of safety cases for nuclear facilities that may be operated by potential licensees, existing licensees, or other duty holders. The underlying framework to the SAPs is described in paragraphs 4 to 17 of that document. The SAPs also provide nuclear site duty holders with information on the regulatory principles against which their safety provisions will be judged. However, they are not intended or sufficient to be used as design or operational standards reflecting the non-prescriptive nature of the UK's nuclear regulatory system.

22 The SAPs assist inspectors in the judgement of whether, in their opinion, the duty holder's safety case has satisfactorily demonstrated that their design has reduced the risks to 'as low as reasonably practicable' (ALARP). A number of numerical targets are included in the SAPs to give guidance on risks that are so low that they may be considered broadly acceptable. However, the legal duty to reduce risk to ALARP applies at all levels of risk and extends below the broadly acceptable level and the requirement to meet relevant good practice in engineering and operational safety management is of prime importance. There is also guidance on risks that are unacceptably high and the associated activities would be ruled out unless there are exceptional reasons.

23 There are 298 principles in total in the SAPs, which are expanded in supporting paragraphs. Table 1 of this report presents the SAPs which are of most relevance to the assessment of civil engineering and external hazards aspects of Westinghouse's GDA

submission. Some of these SAPs are repeated again in this document where relevant to the text.

2.3.3 HSE ND Technical Assessment Guides

- 24 The use of the SAPs is supplemented, as appropriate, with HSE ND Technical Assessment Guides (TAG). The TAGs provide further interpretation of the SAPs and guidance in their application. The TAGs provide guidance in particular technical areas.
- 25 ND maintains its skills resource by using Nuclear Topic Groups (NTG) for each topic area. The members of a NTG are the Inspectors with specialist skills and experience in that topic area. The NTG has the responsibility for the maintenance of TAGs in the appropriate topic area.
- 26 The TAGs applicable to civil engineering and external hazards are listed below.
- T/AST/013 ND BMS. Technical Assessment Guide. External Hazards. Issue 3. HSE. April 2009 (Ref. 13).
 - T/AST/017 ND BMS. Technical Assessment Guide. Structural Integrity Civil Engineering Aspects, Issue 2. HSE. March 2005 (Ref. 14).
 - T/AST/042 ND BMS. Technical Assessment Guide. Validation of Computer Codes and Calculation Methods. Issue 1. HSE. July 2000 (Ref. 15).
 - T/AST/049 ND BMS. Technical Assessment Guide. licensee use of contractors and intelligent customer capability. Issue 3. HSE. September 2009 (Ref. 16).
 - T/AST/057 ND BMS. Technical Assessment Guide. Design Safety Assurance. Issue 2. HSE. November 2010 (Ref. 17).

2.3.4 International Guidance

- 27 The International Atomic Energy Agency (IAEA) is an independent intergovernmental, science and technology-based organisation in the United Nations family that serves as the global focal point for nuclear cooperation. The IAEA nuclear safety standards (Ref. 19) provide a system of fundamental safety principles, safety requirements and safety guides. They reflect an international consensus on what constitutes a high level of safety for protecting people and the environment from harmful effects of ionizing radiation.
- 28 The Western European Nuclear Regulators' Association (WENRA) has published its common 'reference levels' (Ref. 18) in the fields of reactor safety, decommissioning safety, radioactive waste and spent fuel management in order to benchmark national practices. The SAPs note that *"In the UK, the (WENRA) reference levels will be secured using a combination of.....SAPS"*; hence assessment against the SAPs is considered sufficient.
- 29 Generally the SAPs capture the requirements of the IAEA Standards Series and the WENRA reference levels. The SAPs to be considered for this assessment were set out in Table 7 of the Step 4 Plan (Ref. 11), and compared against the WENRA reference levels and the IAEA standards to ensure the primary guidance of the SAPs was comprehensive. The WENRA and IAEA guidance are also embodied and enlarged on in TAGs T/AST/13 and 17 for external hazards and civil engineering respectively.

2.3.5 US Nuclear Regulator

- 30 Westinghouse has carried out its design work in accordance with the US regulatory framework and has submitted its AP1000 design to the United States regulator, the Nuclear Regulatory Commission (US NRC).
- 31 The US NRC had previously carried out an assessment of the AP600, the forerunner to the AP1000 design. No AP600 stations have been built. Westinghouse then subsequently submitted the AP1000 design to the US NRC based on Revision 15 of its Design Control Document (DCD) and this was accepted by the US NRC. The US NRC's recent review has focused on the changes made to the design since the approved Revision 15.
- 32 The US NRC has its own series of Regulatory Guides (RG). Since the regulator provides prescriptive guidance to American license applicants, some of the RGs are treated as design codes by vendors such as Westinghouse. Approved design methods and numerical limits are given in the RGs, to which the licensee's design must comply.
- 33 The UK regulatory framework is not prescriptive and so arguments by Westinghouse that the design complies with Regulatory Guides is not within itself sufficient. My assessment is based on the evidence contained within the PCSR and supporting documents; however my judgement may be informed by the way similar evidence has been assessed by US NRC.

2.4 Assessment Scope

2.4.1 Findings from GDA Step 3

2.4.1.1 Primary Conclusions

- 34 The Step 3 Assessment Report (Ref. 20) concluded that the documentation Westinghouse had produced to support the contemporary PCSR (Ref. 21), covered the areas expected in the scope of a nuclear power plant civil engineering and external hazards safety case. However, it was apparent that the PCSR would need to be significantly revised to meet regulator expectations (refer to Section 3.1.1.1) when it was reissued in December 2009 (Ref. 10). The new revision would need to be assessed during Step 4.
- 35 During the Step 3 assessment process, a Regulatory Observation (RO-AP1000-041) had been raised regarding the Westinghouse submission for steel concrete composite sandwich (SC) structural modules. This novel form of construction was used for the Enhanced Shield Building cylindrical wall and for walls/floors supporting equipment both inside containment and in the Auxiliary Building. There is a lack of an appropriate design code for these type of structures, even within the non-nuclear civil engineering industry. Westinghouse claimed that the design methodology for reinforced concrete structures could be used in accordance with ACI 349-01 Code Requirements for Nuclear Safety Related Concrete Structures and Commentary, ACI 349R-01 American Concrete Institute 2001 (Ref. 22). However, the Step 3 report concluded that the structural modules were outside the scope of applicability of this code and thus raised concerns about reliability of the structures. Such was the gap between the justification presented and that expected by ONR for this novel type of construction, that a Regulatory Issue RI-AP1000-002 was raised at the start of Step 4.
- 36 The hierarchy of the documentation provided under Step 3 was not readily apparent. Although the amount of documentation provided was large and fairly comprehensive, it

had a number of shortfalls in terms of an auditable trail to the supporting evidence for the claims and arguments in the reports. The Step 3 report concluded that this evidence trail would need to be confirmed in Step 4.

37 No documentation was submitted during Step 3 for the screening of external hazards and how the load schedules for the structural design had been derived. Therefore assessment was deferred until Step 4. Westinghouse stated that the design load schedule applied to the plant will require further consideration of external hazards once a site or sites have been identified. No evidence was provided for a consideration of lightning or malicious acts (other than malicious large commercial aircraft) as external hazards. In addition, there was no specific recognition of climate change as a driver for a number of hazards. Common cause failure needed to be addressed.

38 Some of the primary supporting references for the PCSR were not provided until the end of Step 3 and so had to be assessed during Step 4. These included documents on:

- the External Hazards Topic Report.
- the Design Methodology for Structural Modules.
- the UK Safety Categorisation and Classification Methodology.
- codes and standards.
- AP1000 Standard Plant Metrication.

2.4.1.2 Remaining Conclusions

39 The remaining findings of the Step 3 assessment report were as follows:

40 There had been no justification that adequate segregation was provided in the diesel generator house, since the two generators were housed in the same building. This meant both generators could be affected simultaneously by a single external hazard event.

41 It was concluded that the codes and standards used for the design of the AP1000 had now been superseded. Westinghouse agreed to submit a codes and standard gap analysis during Step 4 to justify that the currency of superseded standards used was still valid. This was to be related to the safety categorisation of the AP1000 systems, structures and components (SSC).

42 The safety categorisation system was based on USA practice and documents substantiating how this was to be aligned with UK practice were to be submitted during Step 4. The assignment of the Radwaste Building as Category C-III needed further consideration.

43 The concept structural layout of the nuclear island was reviewed during Step 3 and it was noted that the asymmetry between RC and SC sections of the Shield Building wall may cause amplification of the seismic response. Therefore during Step 4, the seismic analyses should be sampled to confirm if transverse and torsional asymmetry has been correctly accounted for in the design. The detailing of specific connection points were identified for sampling, i.e. between RC and SC wall sections and between Auxiliary Building roof and shield wall.

44 Nuclear safety regulation in the UK is concerned with construction quality assurance as well as civil engineering design. This is to ensure that structures are actually constructed in accordance with the design and fulfil their safety functional requirements. The Step 3 PCSR did not include any information on construction quality assurance and

specifications and thus Westinghouse committed to include in the next issue of the PCSR.

- 45 The plans in the PCSR were considered adequate at that stage (Step 3) in respect of civil engineering provision for decommissioning.
- 46 The design of the supporting structure and local details of the passive containment cooling system water tank (PCS) require detailed scrutiny as they provide a significant load on the Shield Building structure, especially in the seismic loadcase.
- 47 The effect of metrication on the US driven design was not considered in detail at Step 3. Following receipt of the Westinghouse approach to this topic in Step 4, a more considered assessment would need to be made.
- 48 The role of some computer codes, such as Vector in the analysis of the structures, requires further clarification and appropriate assessment in Step 4. A more complete overview of the seismic and aircraft impact modelling will be undertaken during Step 4.
- 49 Westinghouse was initially unable to supply a design methodology for the SC modules which would have been made available to its design contractors in advance of the design. The primary concern was the lack of a design basis document. However it also raised a concern that Westinghouse has not been controlling its contractors appropriately. Since the design teams working for Westinghouse on civil engineering design were spread over several locations and organisations, a deeper review of control of design was recommended for Step 4.

2.4.2 Additional Areas for Step 4 Civil Engineering and External Hazards Assessment

- 50 Table 2 below summarises the areas of assessment considered in my Step 4 assessment. The areas identified initially in the Step 4 Assessment Plan are listed first. Further areas of inquiry that have emerged through the progression of these initial areas are listed secondly.

Table 2
Step 4 Assessment Plan

	Assessment Area	Description
Initial List of Areas Identified in the Step 4 Assessment Plan		
1	External Hazards	Substantiation of external hazards claims made in the PCSR. Includes substantiation of screening of external hazards.
2	External Hazards	Detailed assessment of external hazards, including malicious aircraft impact, deferred to Step 4. Includes load derivation methodology and load application to civil structures.
3	Segregation against external hazards	Adequacy of segregation provided by the layout in the context of external hazards and ability to withstand internal hazards.
4	Documentation	Identification of the most relevant documents for assessment using a logical hierarchical structure between documents.
5	Codes and standards	Use of superseded codes and standards in the design of AP1000 and the currency of the superseded standards used.

Table 2
Step 4 Assessment Plan

	Assessment Area	Description
6	Safety categorisation	Suitability of codes and standards for the safety categorisation of the structures.
7	Safety categorisation	The safety categorisation system is based on USA practice and needs further study following receipt of the Safety Categorisation report mentioned above. The assignment of the Radwaste Building as Category C-III needs further consideration.
8	Structural discontinuities in Nuclear Island	Transverse and torsional asymmetry and amplification of seismic response due to differing forms of construction. The detailing between the RC and SC sections of the Shield Building wall and the Auxiliary Building.
9	Construction verification	Construction verification not addressed in previous PCSR. Evidence required on what construction verification is proposed.
10	Decommission-ing	Verify that the conclusion of Step 3 Report holds in the revised PCSR.
11	Structural design of PCS water tank	The design of the supporting structure and local details of the PCS water tank require detailed scrutiny, as they provide a significant load on the Shield Building structure especially in the seismic loadcase.
12	Metrication	The effect of metrication on the US driven design has not been considered in detail at Step 3. Following receipt of the Westinghouse approach to this topic in Step 4 a more considered assessment will be made.
13	Analysis	The role of computer codes in the analysis of the structures requires further clarification and appropriate assessment in Step 4.
14	Analysis	A more complete overview of the seismic and aircraft impact modelling will be undertaken during Step 4.
15	Control of Design	The control of subcontractors for the design of key elements of the structures requires further evaluation.
16	SCS module design	Review the design methodology for the SC modules (APP-GW-SUP-001 Rev 0) which was received too late for consideration in the Step 3 Report.
17	Use of design codes outside scope of application for SCS structures	Review Westinghouse's design to ACI-349. Technical concerns include transverse shear, in plane shear, and the effect of thermal loads on the plate to concrete bond.
18	Structural reliability of SCS structures	Structural reliability arising from the combined effects of design code (or other design methodology), loads, analysis, modelling and construction verification.

Table 2
Step 4 Assessment Plan

	Assessment Area	Description
Further Areas Identified during Step 4		
19	Spent Fuel Pool Liner	Provision of secondary containment and leak detection measures
20	Foundations	Nuclear island foundations and Auxiliary Building basement walls.
21	Containment Vessel	Interfaces with civil structures, including joints with concrete structures.
22	IRWST	Construction details and leak protection measures
23	Inspection and Maintenance	General provisions. Specific provisions for SC structures.
24	Shield Plate	Review of design of support structure.

2.4.3 Use of Technical Support Contractors

51 Technical support contractors (TSC) were appointed by HSE ND to support my assessment work during Step 4. These contractors are design consultancies who have the necessary specialist skills and expertise in the detailed technical areas which needed assessing. Three consultants were used:

2.4.3.1 ABS Consulting

52 ABS Consulting Ltd (ABSC) was appointed for its expertise in global safety, risk and integrity management. Assessment of the following technical areas was carried out:

- External Hazards claims and dependencies.
- Safety Categorisation.
- Load Schedule Development.
- Application of Load Schedule.
- Audit Trail from High Level Documents through to Calculations.
- Seismic PSA (Seismic Margins) Assessment.
- PSA (Non-seismic).

53 The conclusions of ABSC's work for this report are documented in five reports for Step 4 (Ref. 23 to 27).

2.4.3.2 Amec Nuclear UK Ltd

54 Amec Nuclear UK Ltd (Amec) was appointed for its expertise in steel/concrete composite construction for the following technical work:

- A detailed assessment of the available public and proprietary technical information surrounding steel-concrete (SC) modular wall design and construction.

- Consideration of the relevant methodologies implemented in Westinghouse's design guides.
- A detailed review of the SC wall modules employed in the in-containment structures and the Enhanced Shield Building (ESB).
- Independent numerical simulations to support concerns on particularly complex structural mechanisms.

55 The conclusions of Amec's review are documented in two reports for Step 4 (Ref. 28 and Ref. 29).

2.4.3.3 Ove Arup & Partners Ltd

56 Ove Arup & Partners Ltd (Arup) was appointed for its expertise in steel/concrete composite construction, impact assessment and seismic analysis. The following five specific tasks were instructed and these are documented in five reports for Step 4:

- Reviews of existing information about steel concrete sandwich construction carried out by other TSCs during Step 3 (Ref. 30).
- A review of the Westinghouse design methodology and design details for the steel concrete steel sandwich construction used for the CA Modules (Ref. 31).
- A review of the Westinghouse design methodology and design details for the ESB (Ref. 32).
- A review of the methodology for evaluation of aircraft impact (Ref. 33).
- A review of Westinghouse's seismic methodology (Ref. 34).

2.4.4 Integration with other Assessment Topics

57 There are a number of technical areas which have a significant interaction with civil engineering and external hazards. All assessment topics are listed in Table 3 below and those areas that have required integrated working between Inspectors are noted. The detail of these interfaces are referred to in the relevant sections of this report.

2.4.5 Cross-cutting Topics

58 The cross-cutting topics assessment report (Ref. 51) has raised the following as issues which cut across the various topic areas:

- Operational limits and conditions derived from the safety case.
- PCSR and supporting documentation – control of master submissions list and subsequent design changes.
- The lessons learnt from the Fukushima Event.
- Metrication.
- Containment of the Spent Fuel Pool

Table 3
Step 4 Assessment Topic Areas

Assessment Topic Area	Assessment Report	Common Areas
Internal Hazards	ONR-GDA-AR-11-001 (Ref. 35)	Load definition. Dropped Loads and impacts. Fire, internal flooding.
Civil Engineering and External Hazards	ONR-GDA-AR-11-002 (this report)	n/a
Probabilistic Safety Analysis	ONR-GDA-AR-11-003 (Ref. 37)	fragility derivation and claims
Fault Studies	ONR-GDA-AR-11-004a and b (Ref. 38 and 39)	load definition
Fuel and Core Design	ONR-GDA-AR-11-005 (Ref. 40)	n/a
Control and Instrumentation	ONR-GDA-AR-11-006 (Ref. 41)	protection to systems
Electrical Systems	ONR-GDA-AR-11-007 (Ref. 42)	diesel generator separation
Reactor Chemistry	ONR-GDA-AR-11-008 (Ref. 43)	effect of borated water on civil structures
Radiological Protection	ONR-GDA-AR-11-009 (Ref. 44)	spent fuel pool operation
Mechanical Engineering	ONR-GDA-AR-11-010 (Ref. 45)	metrication of plant supports and civil structures
Structural Integrity	ONR-GDA-AR-11-011 (Ref. 46)	interfaces with civil structures/supports
Human Factors	ONR-GDA-AR-11-012 (Ref. 47)	n/a
Management of Safety and Quality Assurance	ONR-GDA-AR-11-013 (Ref. 48)	quality assurance of sub-consultants
Radioactive Waste and Decommissioning	ONR-GDA-AR-11-014 (Ref. 49)	decommissioning
Security Assessment	ONR-GDA-AR-11-015 (Ref. 50)	Aircraft Impact
Cross-cutting Topics	ONR-GDA-AR-11-016 (Ref. 51)	See Section 2.4.5

2.4.6 Out of Scope Items

59

The items that have been agreed with Westinghouse as being outside the scope of GDA are detailed in Westinghouse letter UN REG WEC 000512 (Ref. 9). Although the letter

does not list any items directly under civil engineering and external hazards, the following items will have an influence:

- Facilities for decontamination - The effect on building structures within the GDA scope will need to be confirmed and, if necessary, assessed.
- Detailed design of radwaste processing facilities outside the nuclear island. The current Radwaste Building is therefore to be reviewed and this may affect the building structures. Therefore, this is out of scope of my GDA Step 4 assessment.
- QA arrangements for early procurement of long lead items. This will affect long lead items such as CA Modules and ESB. Therefore, this is out of scope of my GDA Step 4 assessment.

3 WESTINGHOUSE'S SAFETY CASE

3.1 Safety Case Documentation

3.1.1 Pre-construction Safety Report

3.1.1.1 Background

60 The generic Pre-construction Safety Report (PCSR) is the lead document in the submission by Westinghouse for Step 4 of the Health and Safety Executive (HSE) Nuclear Directorate (ND) and the Environment Agency generic design assessment (GDA) process. Westinghouse notes that the safety case is a live document and will undergo several revisions as a plant moves towards operation.

- Generic PCSR.
- Site Specific PCSR.
- Site Specific pre-commissioning safety report (PCSR).
- Site Specific pre-operational safety report (POSR).
- Site Specific operational safety report (OSR).

61 The PCSR is currently at the first stage above and has been revised 3 times during GDA.

62 The Step 3 assessment focused on the initial generic PCSR (UKP-GW-GL-732 Revision 1 (Ref. 21). This PCSR relied heavily on the European Design Control Document (EDCD) (Ref. 67) which meant that it had not been developed sufficiently for GDA.

63 Westinghouse revised the generic PCSR at the end of Step 3 (UKP-GW-GL-732 Revision 2 (Ref. 10) in December 2009. However, the structure and content of this was still not in line with our expectations. Therefore during Step 4, Westinghouse has continued to progress the PCSR and a new draft was issued to ONR (UKP-GW-GL-793 Revision A (Ref. 1) on 16 December 2010. Westinghouse stated in their accompanying letter (Ref. 68) that:

64 *“During Step 4, increased dialogue with the ND/EA has allowed Westinghouse to gain further understanding of the requirements of a successful pre-construction safety case, the presentation of these claims, arguments and evidence are used as the basis of the document. We have also taken the opportunity to extensively restructure and enhance the PCSR to reflect these discussions.*

65 *“Emphasis has been placed on ensuring that the document is a standalone safety case in its own right and where it calls out to other documents, it does so from the basis of pointing to evidence, with the PCSR providing clarity on the context.*

66 *“As part of the production process Westinghouse has undertaken several reviews involving internal technical staff, potential utility customers and the ND. Where it has been appropriate, comment and feedback from these parties has been incorporated into this draft. Westinghouse would like to highlight the fact that, as previously agreed, there are a number of gaps within the PCSR which will be addressed for the consolidated submission to be made in March 2011.”*

3.1.1.2 Relevant Chapters

67 The chapters most relevant to this Step 4 assessment report for Civil Engineering and External Hazards from both the 2009 PCSR and the 2010 PCSR are shown in Table 4.

Where sections of either PCSR have been used in this assessment, they are referenced appropriately.

Table 4:
PCSR Chapters Relevant to ONR-GDA-AR-11-002

2009 PCSR Relevant Chapters	2010 PCSR Comparison with 2009 PCSR
Chapter 1: Introduction	Chapter 1: Introduction
Chapter 2: General Plant Description	Chapter 6: Plant Description and Operation
Chapter 3: Generic Site Characteristics	Chapter 4: Generic Site Characteristics
Chapter 4: Safety Aspects Of Design	Chapter 5: Engineering Principles Chapter 12: External Hazards
Chapter 5: Safety Assessment Approach	Chapter 2: Safety Case
Chapter 6: Description Of Plant Systems And Their Conformance With Design Requirements	Chapter 6: Plant Description and Operation
Chapter 7: Description Of The Civil Works And Structures And Their Design Requirements For Safety	Chapter 16: Civil Engineering
Chapter 8: ALARP Assessment Of The Design Of The AP1000	Chapter 15: Engineering Substantiation
Chapter 9: Safety Management Throughout The Plant Lifecycle	Chapter 7: Life Cycle Engineering and Safety
Chapter 10: Commissioning	Chapter 7: Life Cycle Engineering and Safety
Chapter 11: Operational Management	Chapter 6: Plant Description and Operation
Chapter 14: Environmental Aspects	Chapter 26: Radioactive Waste Management
Chapter 16: Decommissioning And End Of Life Aspects	Chapter 27: Decommissioning and End of Life Aspects

3.1.2 European DCD

3.1.2.1 Background

- 68 Westinghouse uses the DCD (Design Control Document) as its main vehicle for submitting its safety case to the US regulators. For the UK regulator the European DCD (Ref. 67) was created, which is closely based on the US DCD Revision 17.
- 69 The PCSR states that the EDCD “is a key document for the licensee and design authority that is intended to unify the construction and operation of the AP1000 reactors that are planned in a number of countries.”
- 70 The EDCD is a very large document and has numerous references to more detailed supporting documents.

3.1.2.2 Relevant Sections

71 The following sections of the EDCD are most relevant to the GDA Step 4 assessment of civil engineering and external hazards:

- Section 1.2 General Plant Description.
- Section 3.2 Classification of Structures, Components and Systems.
- Section 3.7 Seismic Design.
- Section 3.8 Design of Category I Structures.
- Appendix 3G Nuclear Island Seismic Analyses.

3.1.3 Primary Supporting Documents

3.1.3.1 Supporting Documents to PCSR

72 Section 1.3 of the December 2009 PCSR (Ref. 10) describes the hierarchy of documents for Westinghouse's GDA submission; "*In general the PCSR sets out the overarching claims, and links the arguments to the specific topic reports*". There are 11 main topic reports plus two major supporting technical documents. Three of the topic reports were noted as still to be issued: Human Factors, Electrical System and Spent Fuel Handling.

73 The introduction to Chapter 16 – Civil Engineering of the 2010 PCSR (Ref. 1) states that it "*makes extensive reference to the AP1000 European Design Control Document*" and other Westinghouse documents shown in Figure 16-1, namely:

- APP-1200-S3R-003 Enhanced Shield Building Report (Ref. 69 to 72).
- UKP-GW-GLR-018 Response to RI-AP1000-02 (Ref. 73).
- Detailed civil engineering substantiation – drawings, calculations, design/test reports, etc.
- AP1000 design criteria documents and design methodology documents.

74 Chapter 12 – External hazards of the 2010 PCSR again makes the EDCD its primary reference. It also directly references 7 other Westinghouse documents.

75 Table 5 below presents the 2009 PCSR references relevant to civil engineering and external hazards and also lists the references from Chapter 12 and Chapter 16 of the 2010 PCSR. The PCSR references are taken to be the primary references and were used to identify the secondary references that supported them. Specific secondary supporting documents were selected for review as part of a structured approach to sampling and assessment.

76 The documents used in my assessment are listed at the beginning of each section.

Table 5

Primary References for Civil Engineering and External Hazards

	Westinghouse Document Number and Title	2009 PCSR	2010 PCSR Chapter 12	2010 PCSR Chapter 16
1	UKP-GW-GL-737 AP1000 Plant Life Cycle Safety Report	Revision 1		
2	UKP-GW-GLR-003 AP1000 Fault Schedule for the United Kingdom	Revision 0 Sept 2009		
3	UKP-GW-GLR-001, AP1000 Internal Hazards Topic Report	Revision 1 Feb 2010 (Ref. 74)	Revision 1 Feb 2010 (Ref. 74)	
4	UKP-GW-GL-043, AP1000 External Hazards Topic Report	Revision 1 Dec 2009 (Ref. 75)	Revision 1 Dec 2009 (Ref. 75)	
5	UKP-GW-GL-044, AP1000 Safety Categorisation and Classification	Revision 0 Dec 2009 (Ref. 76)	Revision 1 issued April 2010, but not referenced in 2010 PCSR Chapters 12 and 16.	
6	UKP-GW-GL-736, Safe Operating Envelope and Operating Regime that Maintains Integrity of Envelope	Revision 0 Nov 2008		
7	APP-GW-GER-005 Safe and Simple: the Genesis and Process of the AP1000 Design	Revision 1 Aug 2008		
8	UKP-GW-GL-045, AP1000 Equivalence/ Maturity Study of the US Codes and Standards	Revision 0 (Ref. 77)		Revision 0 (Ref. 77)
9	EPS-GW-GL-700, AP1000 European Design Control Document	Revision 1 Dec 2009 (Ref. 67)	Revision 1 Dec 2009 (Ref. 67)	Revision 1 Dec 2009 (Ref. 67)
10	UKP-GW-GL-790 UK AP1000 Environment Report	Revision 2 Dec 2009		
11	APP-1200-S3R-003 Enhanced Shield Building Design Report			Revision 3 Sept 2010 (Ref. 72)

Table 5

Primary References for Civil Engineering and External Hazards

	Westinghouse Document Number and Title	2009 PCSR	2010 PCSR Chapter 12	2010 PCSR Chapter 16
12	UKP-GW-GLR-018 Response to RI-AP1000-02			Revision A October 2010 (Ref. 73)
13	APP-GW-GLR-133, Summary of Automobile Tornado Missile 30' Above Grade		Revision 1, May 2010, (Ref. 78)	Revision 1, May 2010, (Ref. 78)
14	APP-GW-GL-022, AP1000 Probabilistic Risk Assessment		Revision 8 July 2004, (Ref. 79)	
15	APP-GW-C1C-001 Wind Evaluation Procedures and Code Requirements		Revision 0, April 2004 (Ref. 80)	
16	APP-GW-C1-001 Civil/Structural Design Criteria		Revision 1 Sept 2005 (Ref. 81)	Revision 1 Sept 2005 (Ref. 81)
17	APP-GW-G1-003 AP1000 Seismic Design Criteria		Revision 3 Sept 2009 (Ref. 82)	Revision 3 Sept 2009 (Ref. 82)
18	APP-GW-P1-002 AP1000 General Layout Criteria,			Revision 0 May 2009 (Ref. 83)
19	APP-GW-GLR-045, Nuclear Island: Evaluation of Critical Sections			Revision 1 July 2009 (Ref. 84)
20	APP-GW-SUP-001, Design Methodology for Structural Modules			Revision 1 and Revision 2 (Ref. 85 and 86)
21	APP-1000-GEC-004, AP1000 Barrier Matrix			Revision A January 2010 (Ref. 87)

3.2 Description of the Generic Site

77 The layout of the main civil structures is described in Section 2.4 of the 2009 PCSR (Ref. 10) and in Section 1.2.1.6 of the EDCD (Ref. 67). The site plan will be defined in the site specific licensing process. The generic design is based on the site plan shown in Figure 1.2-2 of EDCD and is reproduced in Figure 1 below.

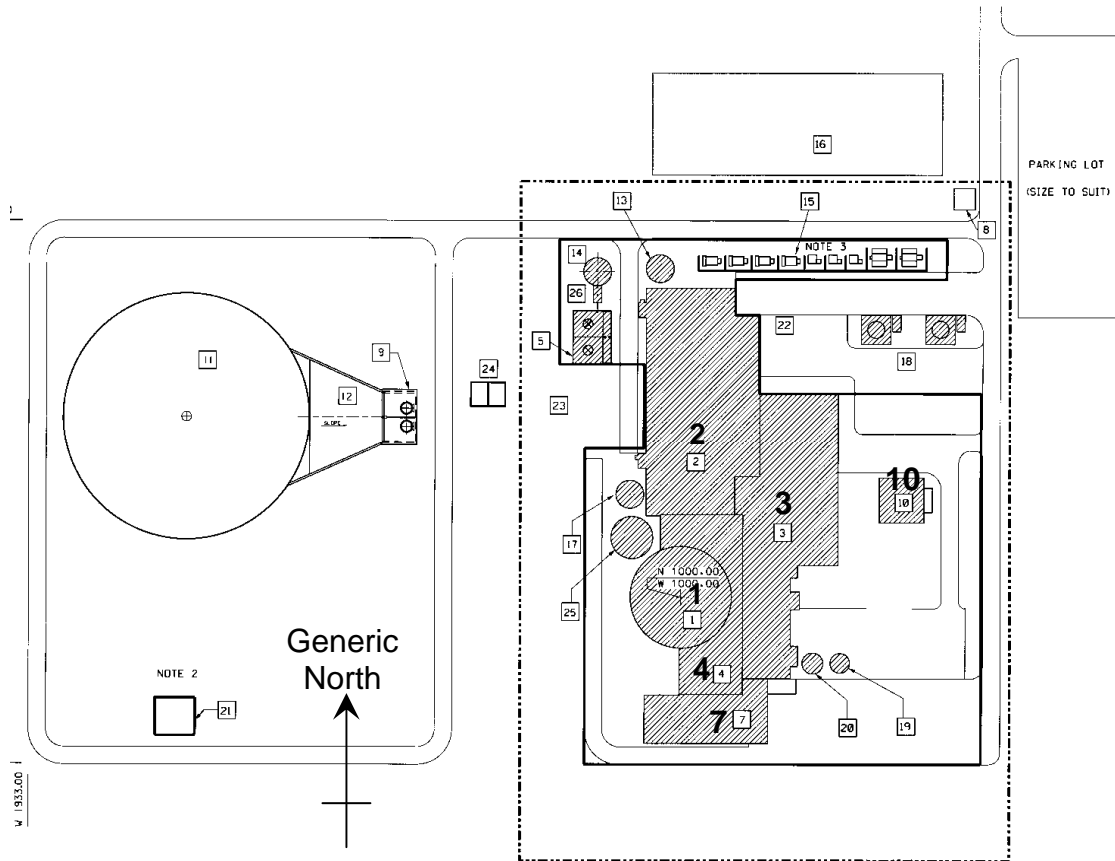

Figure 1: Generic Site Plan

78 Buildings or structures within the GDA Scope are shown hatched in Figure 1. The plant arrangement consists of the following five principal building structures.

- Nuclear Island which comprises
 - containment/Shield Building (1); and
 - Auxiliary Building (4).
- Turbine Building (2).
- Annex Building (3).
- Radwaste Building (7).
- Diesel Generator Building (10).

79 It should be noted that the Radwaste Building (7) was moved to out of scope in February 2011. The left hand side of the plan shows a possible cooling water tower and pumphouse which will be site specific and so are out of scope of GDA.

- 80 The containment building comprises the containment vessel and the structures contained within it. The containment vessel (CV) is designed to house the reactor pressure vessel, steam generators, the in-containment refuelling water storage tank (IRWST) and other related systems. These items of plant are supported by civil structures built within the CV. These civil structures are known as containment internal structures (CIS).

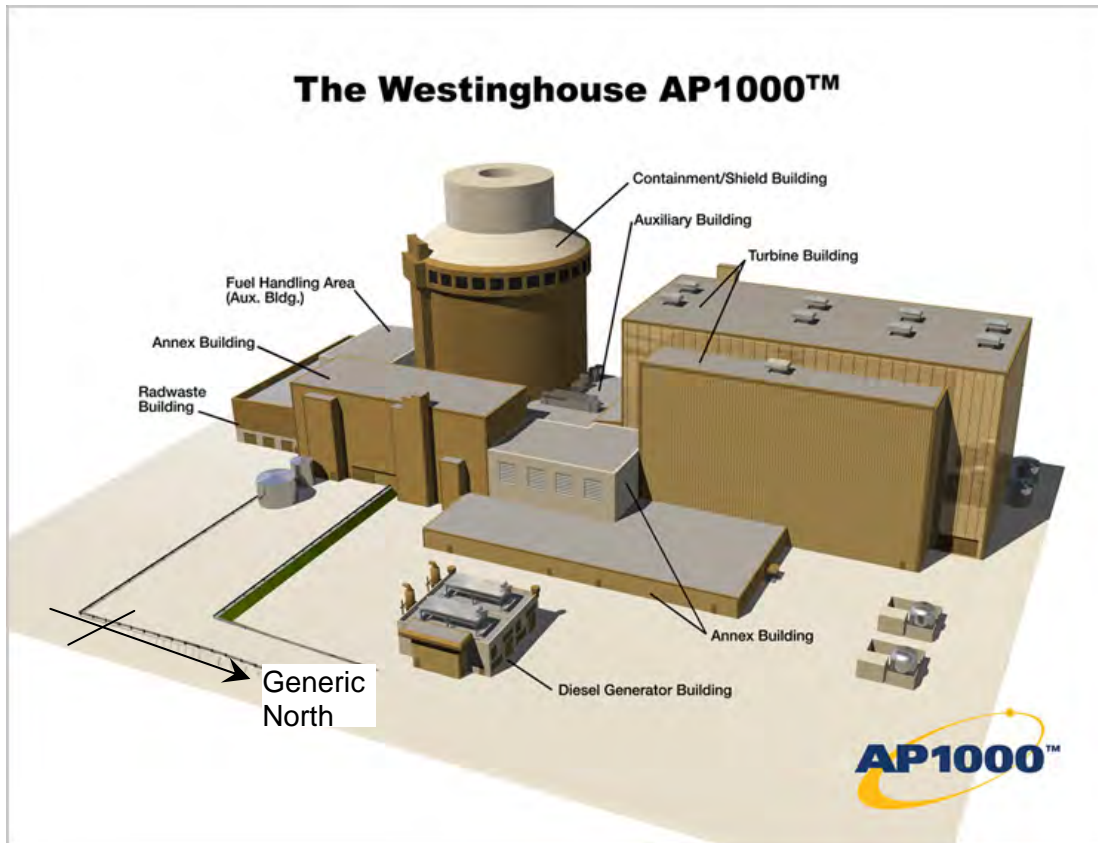

Figure 2: General View of AP1000 Plant

- 81 The Shield Building is the structure that surrounds the containment vessel. Its primary function is to provide shielding and protect the CV from external hazards. It also forms an integral part of the passive cooling system by providing an air gap around the CV for natural air circulation. It supports the passive containment cooling system water storage tank (PCS tank) above the CV, which is used for cooling during fault events. The air circulation around the CV is provided by air inlets at the eaves of the Shield Building through which air is drawn into the gap or annulus between the Shield Building and the CV. The air is then directed by baffles along the outer surface of the CV, which cools it, and rises up through the air diffuser in the centre of the roof.
- 82 The primary function of the Auxiliary Building is to provide protection and separation for the safety Class 1 mechanical and electrical equipment, which is located outside the containment building. It has two distinct sides; the radiological side (south) and the non-radiological side (north).
- 83 Westinghouse state that “*The turbine, annex, diesel generator, and radwaste buildings contain no equipment that is essential to nuclear safety, therefore their hazard-withstand requirement is less onerous than that for the nuclear island*” (Section 2.4.3 of 2009 PCSR, Ref. 10).

3.3 Building Layouts

3.3.1 Foundations

- 84 This section describes the main features of the foundations, with particular emphasis on the nuclear island. Refer to Section 4.11 for my assessment of this.
- 85 An isometric view of the building structures is presented previously in Figure 2. The nuclear island has one foundation raft slab which supports both the Shield Building and the Auxiliary Building. There is no isolation between these two buildings such that they are effectively the same building and are sometimes referred to as the ASB or Auxiliary Shield Building. Adjoining buildings such as the Radwaste Building, Turbine Building and Annex Building, are structurally separated from the nuclear island structures by a 50mm (2") gap between foundations. A 100mm (4") minimum gap is provided between superstructures.
- 86 The nuclear island is embedded approximately 12m (40 feet) with the formation level at elevation 87.960m (60'-6") and nominal ground level at elevation 100.0m (100'-0"). The foundation is 1.8m thick (6ft) with a top of slab level of 89.8m (66'-6"). It is designed primarily by applying the design loads to the structures, calculating shears and moments in the slab and determining the required reinforcement. The raft is considered to be stiffened by the walls of the ASB.
- 87 A settlement analysis of the nuclear island foundation has been carried out to ensure it is not overstressed by differential settlement during construction. Refer to Section 4.11.3 for further details.
- 88 Waterproofing is provided to the underside of the nuclear island raft foundation and up the outside of the basement walls. This is to prevent the infiltration of ground water. The waterproof membrane underneath the slab has a seismic class I function, since it must ensure there is no slip between raft and formation during the safe shutdown earthquake (SSE) loading (Section 3.4.1.1.1.1 of EDCD).
- 89 The foundations and exterior walls of the nuclear island are designed to resist upward and lateral pressures caused by the probable maximum flood and high ground water level. Minimum factors of safety for overturning, sliding and flotation are provided by the design. Maximum water level for site flooding is defined as below the finished grade and dynamic forces from ponding rainfall is not considered in the analysis or design, since the finished grade is adequately sloped (Section 3.4.1.2.1 of EDCD).
- 90 The foundations for the ancillary buildings, i.e. Category II buildings, are all simple raft foundation slabs with thickenings underneath the superstructure main supports. These rafts are founded just below ground level such that they are approximately 10m above the nuclear island formation level.

3.3.2 Containment Vessel

- 91 The tall cylindrical building is the Shield Building. This forms the protective envelope to the containment vessel, which is a free standing cylindrical steel vessel with elliptical upper and lower heads (refer to Figure 3). The vessel is 39.6m in diameter, 65.6m in height and is generally 44mm in thickness. It is designed to resist mainly internal pressure but also a much smaller external pressure, which requires hoop stiffeners to be provided inside the vessel.
- 92 The lower head is encased in concrete both internally and externally. The vessel thickness is increased to 47.6mm locally to the embedment transition region as a

corrosion allowance. Seals are provided at the top of the concrete on the inside and outside of the vessel to prevent moisture between the vessel and concrete (Section 3.8.2.1 of EDCD).

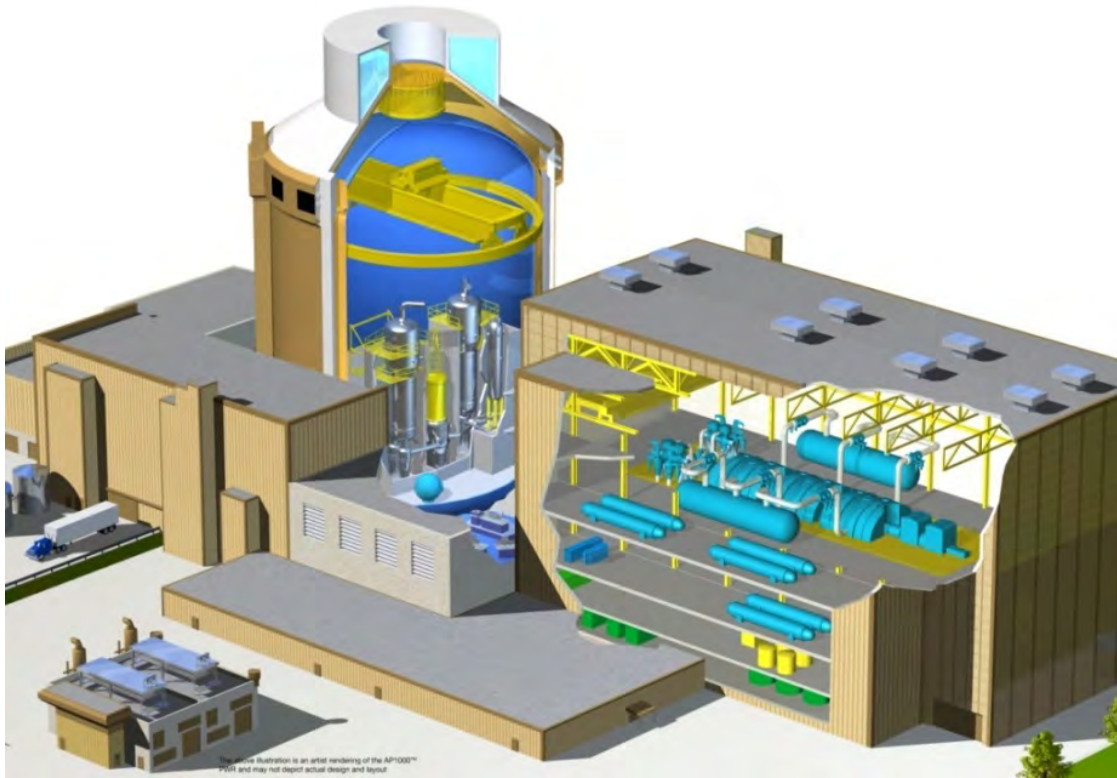

Figure 3: Cut View of AP1000 Plant

- 93 The containment vessel is designed to house the reactor pressure vessel, the steam generators, the reactor coolant system and other related systems during normal operations and provides a high degree of leak tightness. The containment vessel is also integral to the control of the release of airborne radioactivity following design basis accidents (Section 1.2.4.1 of EDCD).
- 94 The containment vessel also supports the polar crane. The crane rail is mounted on the inside face of the steel cylindrical shell. This rail also serves as a hoop stiffener for the design for external pressure. The polar crane is mainly used for handling the reactor vessel head during normal refuelling operations, but also has an auxiliary hook for smaller equipment. The crane girder and wheel assemblies are designed to support a special trolley to be installed in the event of steam generator replacement. Either steam generator can then be lifted through a temporary opening cut in the top of the containment vessel using a large mobile crane. (Sections 1.2.4.1 and 3.8.2.1 of EDCD).
- 95 The air baffles are steel plates that hang vertically between the CV and the Shield Building (refer to Figure 4). The air baffle separates the downward air flow entering at the air inlets from the upward air flow that cools the containment vessel and flows out of the discharge stack. These baffles are attached directly to the outside face of the CV and are arranged to permit inspection of this face. Steel plates are welded to the top dome as part of the water distribution system for the passive cooling system.

-
- 96 Vertical and lateral loads on the CV and internal structures are transferred to the foundation below the vessel by shear studs, friction and bearing. The shear studs are not required for design basis loads. They provide additional margin for earthquakes beyond the safe shutdown earthquake (Section 3.8.2.1 of EDCD).

3.3.3 Containment Internal Structures

- 97 The containment internal structures (CIS) are those concrete and steel structures inside (not part of) the containment vessel that support the reactor coolant system components and related piping systems and equipment. The concrete and steel structures also provide radiation shielding. The CIS consist of the primary shield wall, reactor cavity, secondary shield walls, in-containment refuelling water storage tank (IRWST), refuelling cavity walls, operating floor, intermediate floors and various platforms. (Section 3.8.3 of EDCD).
- 98 The CIS are formed by concrete being poured into the bottom head of the CV to form a level platform. Pits within this concrete, e.g. the reactor lower cavity, are constructed using permanent steel form modules which consist of steel plate stiffened with angles and tee sections. Walls above this level are constructed from concrete filled steel plate structural modules (SC modules) which are pre-fabricated and lifted as a whole into final position on top of the CIS concrete base. The steel module is then filled with concrete.
- 99 The IRWST water tank is formed by SC modules to the west and a curved, single steel plate wall to the remainder. The roof of the IRWST water tank is a composite steel floor. Walls and floors of the modules, which are exposed to water during normal operation or refuelling, are constructed from duplex stainless steel plates.
- 100 There are two operating floors; ground floor maintenance access and operating deck. The operating deck is a mixture of composite concrete slabs and structural steel platforms. The steel platforms are supported by the SC modules and by a perimeter line of steel columns such that no loads are transferred to the CV.

3.3.4 Shield Building

- 101 The Shield Building is described in Section 7.2 of 2009 PCSR (Ref. 10). Additional information on the Shield Building is provided by document APP-1200-S3R-003 Design Report for the Shield Building (Ref. 72). Figure ES-2 from that report was also included in a presentation to a public meeting on 18 November 2009 and so is reproduced in Figure 4.
- 102 The Shield Building cylindrical wall is approximately 42.3m in diameter internally and 53.3m high, above which is a conical roof that supports the PCS water tank. The base of the wall is generally at ground floor level (100.0m), below which is a massive concrete structure which forms the infill between the raft foundation and the CV lower head. This infill is therefore 10m thick at the circumference and gradually reduces in thickness towards the centre of the CV.
- 103 Most of the Shield Building wall is of SC construction, i.e. steel plate/concrete/steel plate sandwich construction. At the lower levels on the north, east and south sides where the wall is inside the Auxiliary Building, it is normal reinforced concrete (RC) construction. The wall is generally 914mm (3ft) thick except at the very top where it thickens to 1.37m (4.5ft). This thickening is required to house the air inlets for the natural air cooling system

and to match up to the tension ring at eaves level. The air inlets comprise two rows of circular tubes around the full circumference of the Shield Building.

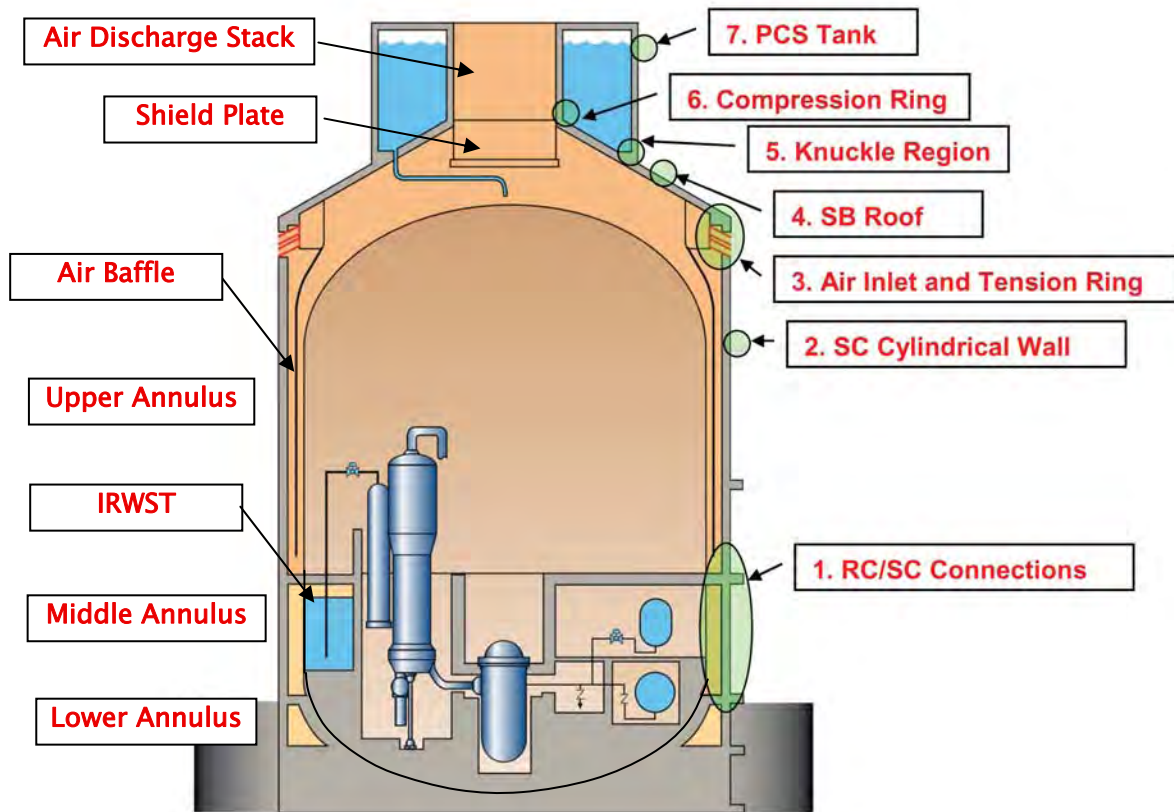

Figure 4: Typical Section Through Shield Building

- 104 The SC wall construction is designed to provide aircraft impact resistance and the addition of this wall type is the major difference between the AP1000 design and the earlier AP600 design. This construction has resulted in the building being called the Enhanced Shield Building (ESB).
- 105 The annulus between the Shield Building and the CV is split into upper, middle and lower portions (see Figure 4). The upper annulus is permanently open to the environment via the air inlets, although screens are provided to stop debris or animals from entering. The air baffles are hung within the upper annulus. The middle annulus area contains the majority of containment penetrations and radioactive piping. Therefore, a watertight seal is provided between the upper and middle annulus areas at elevation 109.830m (132'-3") to provide an environmental barrier. Drains are provided to the floor of the upper annulus to direct any runoff water out of the Shield Building (Section 7.2 of 2009 PCSR).
- 106 The conical roof is formed from steel rafters which span radially between the circular eaves and the centre of the building. Stability is provided by the tension ring at the eaves and the compression ring at the centre. The roof slab is reinforced concrete cast onto permanent steel plate and spans between the rafters. The conical roof supports the PCS

water storage tank which is constructed from an inner and outer cylindrical reinforced concrete wall. The tank is split into quadrants by dividing RC walls. All internal faces are lined with stainless steel to provide water tightness. The inner tank wall forms the circular air discharge stack in the centre of the roof and this discharges containment cooling air directly upwards.

- 107 There are two structures suspended from the conical roof. Firstly, a suspended slab directly beneath the air discharge stack called the shield plate which prevents radiation shine upwards from the CV. Screens are provided to prevent ingress of debris and birds and rainwater is collected by the plate and drained away. Secondly, there is the tank valve room which is suspended under the south east side of the roof. Both of these floors and the PCS tank are accessed by an 'external' staircase and lift. A door opening from the top of the stairs is formed through the SC wall of the Shield Building.
- 108 The shield slab has a central removable octagonal section. In the event that a steam generator needs replacing, this central section can be removed and the steam generator can be lifted through this hole and out through the roof stack by an external crane.

3.3.5 Auxiliary Building

- 109 The Auxiliary Building structure is described in Section 7.2 of 2009 PCRS (Ref. 10).
- 110 The Auxiliary Building is a reinforced concrete structure. It shares a common reinforced concrete raft foundation with the containment vessel and the Shield Building. The Auxiliary Building wraps around approximately 70% of the perimeter of the Shield Building. Floor slabs and the structural walls of the Auxiliary Building are structurally connected to the cylindrical wall of the Shield Building.
- 111 The Auxiliary Building structure consists of vertical shear/bearing walls and horizontal floor slabs. The walls carry the vertical loads from the structure to the raft foundation. Lateral loads are transferred to the walls by the roof and floor slabs and the walls then transmit the loads to the foundation. The walls also provide stiffness to the raft slab and distribute the foundation loads between them.
- 112 The two sides of the Auxiliary Building, the radiological controlled side and the non-radiological side, are physically separated by structural walls which form a continuous barrier from roof to foundation. There are no doors through these walls and any penetrations for pipes, ducts or electrical cables are either above 100.0m level or are sealed to prevent flooding or fire across the boundary as required.
- 113 The north Auxiliary Building is generally constructed of reinforced concrete walls and floors as described above and comprises individual plant rooms. The roof level is 118m and has two floors within the basement at approximately 90m and 80m levels. The perimeter walls to the basement are designed as earth retaining walls. The floors are constructed using a steel deck as permanent formwork. Some floors use bespoke steel decks fabricated from steel plate and sections and so are designed as composite floors utilising the steel strength. These are termed half-plate floors. Other floors are designed as traditional RC and the proprietary Q-deck is used to support the wet concrete loads.
- 114 The south Auxiliary Building has a different structural form to the north. The southern end is the fuel handling area and is taller (24m above ground level) than the eastern and northern parts of the Auxiliary Building (18m). It has the same two levels of basement and the basement walls are earth retaining structures. However, at its centre, a SC module is used for the cell structure of the spent fuel pool, cask loading pit, etc. This

module is pre-fabricated and lifted as a whole into its final position on top of the nuclear island foundation. It is then filled with concrete.

115 The whole of the southern part of the building above the spent fuel pool is one room, 30m by 21m by 13m high, which forms the fuel handling area. The superstructure comprises substantial RC walls to all four sides and an RC roof slab. Below the level of the spent fuel pool there are various building floors which span between the perimeter walls and the SC module.

116 A fuel handling machine is provided to move the spent fuel assemblies between the fuel transfer canal, the spent fuel pool and the cask loading pit. The fuel handling machine is a gantry crane which spans north to south across the full width of the fuel handling area. A cask handling crane is also located in the fuel handling area. This crane is designed to transport the spent fuel cask between the rail car bay, the cask loading pit and the cask washdown pit. The crane rail length and rail stop limits the crane travel and thus precludes the movement of this crane in the near vicinity of the spent fuel pool.

3.3.6 Annex Building

117 The Annex Building includes the health physics facilities and provides personnel and equipment access ways to and from the containment building and the rest of the radiological control area via the Auxiliary Building.

118 The Annex Building is a combination of reinforced concrete structure and steel framed structure with insulated metal cladding. Floor and roof slabs are reinforced concrete supported by metal decking. Floors are designed to act as diaphragms to transmit horizontal loads to side wall bracing and to concrete shear walls. The building foundation is a reinforced concrete raft (Section 1.2.5 of EDCD).

3.3.7 Diesel Generator Building

119 The Diesel Generator Building houses the two diesel generators and their associated heating, ventilating and air conditioning equipment, none of which are required for the safe shutdown of the plant.

120 The building is a 6.5m tall single story steel framed structure with insulated metal cladding. The roof is composed of a metal deck supporting a concrete slab and serves as a horizontal diaphragm to transmit lateral loads to sidewall bracing and thereby to the foundation. The foundation consists of a reinforced concrete raft with thickenings under the superstructure. The diesel generators are skid-mounted and rest on vibration isolators supported directly from the mat. The two generators are separated by a central dividing wall which is claimed for 3 hour fire resistance (Section 1.2.6 of EDCD).

3.3.8 Radwaste Building

121 The Radwaste Building includes facilities for segregated storage of various categories of waste prior to processing, for processing by mobile systems and for storing processed waste in shipping and disposal containers.

122 The building is a single storey steel framed superstructure with insulated metal cladding. The liquid radwaste processing areas are designed to contain any liquid spills. These provisions include a raised perimeter and floor drains that lead to the liquid radwaste

system waste holdup tanks. The foundation for the entire building is a reinforced concrete raft with thickenings under the superstructure columns. (Section 1.2.7 of EDCD).

123 It should be noted that the Radwaste Building is now out of scope of the GDA assessment. This is because the waste storage areas are to be reviewed and this may affect the building layout.

3.3.9 Turbine Building

124 The Turbine Building houses the main turbine, generator and associated fluid and electrical systems. It provides weather protection for the laydown and maintenance of major turbine/generator components. The Turbine Building also houses the makeup water purification system.

125 The Turbine Building consists of two sections; the first bay and the main area which houses the turbine. The first bay is immediately adjacent to the Auxiliary Building and it consists of reinforced concrete walls and steel framing with reinforced concrete and steel grated floors. The main area is a steel framed building with reinforced concrete and steel grated floors. The first bay and the main area are two independent structures.

126 The Turbine Building ground floor is a reinforced concrete slab shared by the first bay and main area structure. The turbine-generator is supported on a reinforced concrete deck, mounted on springs, which isolates it dynamically from the remainder of the structure (Section 1.2.8 of EDCD).

3.4 Civil Structures Safety Functions

3.4.1 Overall

127 Section 1.2.1 of the EDCD (Ref. 67) states the reliability and availability objectives for the overall plant. The following are relevant to civil SSCs:

- The plant design objective is 60 years without the planned replacement of the reactor vessel, which itself has a 60 year design objective based on conservative assumptions. The design provides for the replaceability of other major components including the steam generators.
- The design of nuclear safety systems and engineered safety features includes allowances for natural environmental disturbances such as earthquakes, floods and storms at the station site.
- The control room is shielded against radiation so that continued occupancy under accident conditions is possible.
- The fuel handling and storage facility is designed to prevent inadvertent criticality and to maintain shielding and cooling of spent fuel.
- The passive containment cooling system maintains the containment pressure and temperature within the appropriate design limits for both design basis and severe accident scenarios.

3.4.2 Nuclear Island

128 The nuclear island foundation must support the Shield Building and the Auxiliary Building for all design basis events and beyond design basis.

129 The containment internal structures serve the following primary safety functions:

- provides support to the reactor vessel and associated plant during normal operations, design basis events and beyond design basis;
- provides the required shielding; and
- provides containment for the water in the IRWST during normal operations, design basis events and beyond design basis.

130 The Shield Building serves the following primary safety functions (Section 1.2.4.2 of EDCD):

- provides shielding for the Containment Vessel (CV) and the radioactive systems and components located within it;
- protects the CV from external events during normal operations, design basis events and beyond design basis, e.g. aircraft impact;
- provides the required shielding for radioactive airborne materials that may be dispersed in the containment;
- provides support for the passive containment cooling system (PCS) water storage tank for containment cooling; and
- provides for natural air circulation cooling of the CV during normal operation.

131 The Auxiliary Building structure serves the following primary safety functions (Section 1.2.4.3 of EDCD):

- provides protection and separation for the seismic class I mechanical and electrical equipment located outside containment;
- provides protection for the safety-related equipment against the consequences of either a postulated internal or external event;
- provides shielding for the radioactive equipment and piping that is housed within the building;
- supports the main control room (MCR) during normal operations, design basis events and beyond design basis, e.g. aircraft impact;
- provides containment to the south Auxiliary Building for water from the spent fuel pool and adjacent channels; and
- provides containment to the south Auxiliary Building for possible airborne contamination, following any postulated design basis accident such that it does not result in unacceptable site boundary radiation levels.

132 The most significant equipment, systems and functions contained within the Auxiliary Building are the following:

- Main control room.
- Class 1E instrumentation and control systems.
- Class 1E electrical system.
- Fuel handling area.
- Mechanical equipment areas.
- Containment penetration areas.
- Main steam and feedwater isolation valve compartment.

- 133 The spent fuel pool has a cooling system (SFS) which has the following functions (Section 21.7.8.1 of 2010 PCSR Ref. 12):
- Remove decay heat generated by stored fuel assemblies from the water in the SFP.
 - Maintain the water temperature within limits.
 - Clarification and purification of the water in the SFP, transfer canal and refuelling cavity.
 - Transfer water between the IRWST and refuelling cavity during refuelling.
 - Provide cooling and purification of the IRWST during normal operation.

3.4.3 Ancillary Buildings

- 134 The AP1000 design does not claim any safety functional requirement for the three ancillary buildings included in the GDA Scope, as per the statements below from the EDCD. It should be noted that the US term 'safety-related equipment' is equivalent to UK Safety Class 1 equipment.
- 135 *"No safety-related equipment is located in the annex building"* (Section 1.2.5 of EDCD).
- 136 *"No safety-related equipment is located in the diesel generator building"* (Section 1.2.6 of EDCD).
- 137 *"No safety-related equipment is located in the turbine building"*(Section 1.2.8 of EDCD).
- 138 Additionally, no claim is made on the Radwaste Building. Although this is no longer in GDA scope, it is relevant to the query on its classification that was stated in the GDA Step 3 Assessment Report (Ref. 20). The statement made on the Radwaste Building is as follows:
- 139 *"No safety-related equipment is located in the radwaste building"* (Section 1.2.7 of EDCD).

3.5 Categorisation and Classification

3.5.1 Introduction

- 140 The US classification system would normally have 2 classes of structures: nuclear safety related and non-nuclear. Therefore Westinghouse has re-classified its design in accordance with the UK practice. The methodology of this re-classification is given in document UKP-GW-GL-044 (Ref. 76) and the final results are tabulated in document UKP-GW-GL-144 Revision 1 AP1000 UK Safety Categorisation and Classification of Systems, Structures and Components (Ref. 88).
- 141 Section 1.0 of Ref. 76 states that the *"classification of structures, systems, and components (SSCs) is used to identify those SSCs that play an important part in ensuring nuclear safety. This in turn helps to define the quality requirements placed on those SSCs during design and manufacture, and through life. In particular, the safety class of a given SSC can be used to determine which codes, standards, and seismic design considerations are appropriate to the design and manufacture of that SSC."*
- 142 *The purpose of the UK relevant safety assessment principles for nuclear safety for classification of SSCs is to categorise safety functions required to maintain safety in the event of specific fault sequences, identifying which SSCs deliver these safety functions, and classifying them accordingly:*

- *The Safety Category (A, B or C) indicates how important a function is in maintaining nuclear safety.*
- *The Safety Class (1, 2 or 3) indicates how significant the SSC is in maintaining the safety function”.*

143 To aid understanding of the AP1000 safety case, Westinghouse summarises the AP1000 UK design categorisation and classification of SSCs (Section 6.0 of Ref. 77) as follows:

3.5.2 Categorisation

144 Category ‘A’ safety functions are defined as the principal means of maintaining nuclear safety and are those functions utilised to achieve and maintain a non-hazardous, stable state within 72 hours of the initiating event.

145 A Category ‘B’ safety function is a significant contributor to nuclear safety. Category ‘B’ safety functions are utilised to do the following:

- Maintain the non-hazardous stable state after 72 hours following an accident.
- Prevent radiological exposures to on-site personnel and the off-site population from exceeding the design basis limits.
- Mitigate beyond design basis accidents (DBA).

146 Alternatively, failure to maintain the Category B safety function may reduce safety margins significantly, with radiation exposure less than Category ‘A’ limits but greater than normal operating limits.

147 Category ‘C’ safety functions are those safety functions that may make a contribution to nuclear safety but are not categorised as Category A or B. Since the removal of nuclear heat during normal operation prevents reactor trips and the actuation of Category ‘A’ and ‘B’ functions, these normally operating duty systems are recognised as being important to safety.

3.5.3 Classification

148 Class 1 SSCs provide the principal means of fulfilling a Category A safety function. All AP1000 Class 1 SSCs are located in the nuclear island (NI).

149 Class 1 SSCs are standby or normally operating SSCs required to protect against, or mitigate the consequences of, DBAs consistent with the design basis safety analysis. These SSCs provide the principal means for the protection of the health and safety of the public and workforce and are selected using deterministic methods.

150 Class 2 SSCs are the principal means of fulfilling Category B safety functions, or significant contributors to fulfilling Category A safety functions. A significant contributor is defined as an SSC that provides a supplementary capability for those SSCs utilised in the principal response to DBAs.

151 Class 3 SSCs are all other SSCs that are not Class 1 or Class 2 and provide contributions to maintaining nuclear safety, including SSCs identified to support the operation of Class 1 and Class 2 SSCs.

3.5.4 Classification of Buildings for Seismic Hazard

3.5.4.1 Methodology

- 152 The seismic classification methodology adopted for the AP1000 design is summarised in Section 4.5 of the 2009 PCSR (Ref. 10). These definitions are further expanded in Sections 3.2.1.1.1 to 3.2.1.1.3 of the EDCD (Ref. 67). However, the most current definition is in the 2010 PCSR (Ref. 1). It should be noted that Westinghouse use the term 'seismic categorisation' within their reports. I will use the term seismic classification since this more truly reflects the UK system for grouping SSCs.
- 153 A method for categorisation of safety functions and classification of SSCs has been developed by Westinghouse specific to the UK and which is presented in detail in Chapter 5 of the 2010 PCSR. Structures are assigned a seismic classification depending on their required performance during and following a seismic event. Civil engineering structures are categorised according to their safety function and are classified according to their significance in delivering this function according to UK practice. A seismic class is assigned accordingly.
- 154 Section 12.6 of the 2010 PCSR outlines the Westinghouse safety design approach to the treatment of earthquake hazard and states that the SSE is used as a design basis for AP1000 plant Class 1 SSCs. In specifying design criteria for the SSE, consideration is given to lower magnitude earthquakes having a greater probability of occurrence as well as to larger magnitude earthquakes having a lower probability. Westinghouse states that the AP1000 plant has been designed so that any seismic event within the design basis will not prevent the delivery of Category A safety functions.

3.5.4.2 Seismic Classification of Safety Related Systems

- 155 The seismic class definitions are;
- 156 **Seismic Class I (C-I)** – Applies to safety-significant SSCs. C-I SSCs are designed to maintain both functionality and integrity under seismic loading within the design basis.
- 157 **Seismic Class II (C-II)** – Seismic C-II SSCs are designed so that an SSE does not cause unacceptable structural failure of, or interaction with, C-I items that could degrade the functioning of a safety significant SSC to an unacceptable level, or could result in incapacitating injury to occupants of the MCR.
- 158 **Non-Nuclear Seismic Class (NNS)** – NNS SSCs are those that are not classified as C-I or C-II. Even though a structure has been assigned as non-nuclear, some form of seismic justification is undertaken.
- 159 The third category is clarified in the 2010 PCSR as NNS – non-nuclear seismic, since it was referred to as NS – non seismic in the 2009 PCSR and the EDCD. In the UK, a non-nuclear structure would not normally be designed for seismic hazard; however Westinghouse has adopted the US normal industrial practice of providing some form of seismic protection to all new structures on a nuclear power plant.
- 160 Non-nuclear seismic structures are evaluated to determine that their seismic response does not preclude the safety functions of C-I SSCs. This is satisfied by compliance with one of three options:
- The collapse of the non-nuclear seismic structure will not cause it to strike a C-I SSC.
 - The collapse of the non-nuclear seismic structure will not impair the integrity of C-I SSCs.

- The structure is reclassified as C-II and is analysed and designed to prevent its collapse under the SSE.

- 161 Table 4 of AP1000 UK Safety Categorisation and Classification of Systems, Structures and Components (Ref. 88) presents the seismic classifications that have been assigned to the AP1000 safety significant equipment and buildings. This is reproduced below in Table 6. I have used this in preference to Tables 3.2.1 and 3.2.2 of the EDCD and Section 4.1 of the Civil/Structural Design Criteria (Ref. 81).
- 162 Table 6 shows that Westinghouse has split the classification of the Turbine Building and the Annex Building into two distinct parts. The parts of each immediately adjacent to the C-I nuclear island have been categorised as C-II. The parts away from the nuclear island have been categorised as NNS.

Table 6

AP1000 UK Categorisation and Classification of Structures

Structure/Building	UK Safety Category	UK Safety Class	Seismic Class
Containment Vessel	A	1	I
Shield Building	A	1	I
Auxiliary Building	A	1	I
Annex Building Columns A-D/8-13	GNS	GNS	II
Annex Building Columns A-G/13-16	GNS	GNS	NNS
Annex Building Columns E-I.1/2-13	A	2	II
Radwaste Building	B	3	NNS
Diesel Generator Building	A	2	NNS
CW Pumphouse and Towers	GNS	GNS	NNS
Turbine Building – 1st Bay	A	2	II
Turbine Building – Main Area	C	3	NNS

Where: GNS = general non-safety

3.6 Design Standards

- 163 The codes and standards adopted by Westinghouse are listed in Section 3.1 of AP1000 Civil/Structural Design Criteria (Ref. 81) and Section 2 of the Seismic Design Criteria (Ref. 82). These are summarised below in Table 7.
- 164 The AP1000 codes and standards are those applicable at the time the design was started. Westinghouse recognises that many of these standards have now been superseded and has carried out a study on the differences between the codes adopted and their current versions. This study is presented in the AP1000 Equivalence/Maturity Study of the US Codes and Standards, UKP-GW-GL-045 (Ref. 77).

Table 7

AP1000 Codes and Standards

Design Area	Codes and Standards used in AP1000 design
Steel Containment Vessel	American Society of Mechanical Engineers, Boiler and Pressure Vessel Code, Section III, Division 1, Subsection NE, Metal Containment, 2001 plus 2002 Addenda (Ref. 89)
Building code	International Conference of Building Officials, 1997 Uniform Building Code, 1997 (Ref. 90)
Loading code	ASCE Standard 7–98, Minimum Design Loads for Buildings and other Structures, American Society of Civil Engineers, 1998 (Ref. 91)
Seismic analysis for C-I and C-II	ASCE Standard 4–98, Seismic Analysis of Safety-Related Nuclear Structures and Commentary, American Society of Civil Engineers, 1998 (Ref. 92)
Seismic analysis for NNS	Uniform Building Code 1997 (Ref. 90)
Equipment qualification	IEEE Standard 344–1987, IEEE Recommended Practice for Seismic Qualification of Class 1E Equipment for Nuclear Power Generation Stations, IEEE, 1987
Structural concrete design	ACI 349–01, Code Requirements for Nuclear Safety-Related Concrete Structures, American Concrete Institute, 2001 (Ref. 22)
	ACI 318–99, Building Code Requirements for Structural Concrete, American Concrete Institute, 1999 (Ref. 93)
	ACI 301-05 Specification for Structural Concrete for Buildings 2005 (Ref. 94)
	ACI Detailing Manual – 1994, American Concrete Institute SP-66, 1994 (Ref. 95)
Structural steel design	AISC N690–1994, Specification for the Design, Fabrication and Erection of Steel Safety-Related Structures for Nuclear Facilities, American Institute of Steel Construction, 1994 (Ref. 96)
	AISC 341-97, Seismic Provisions for Structural Steel Building Buildings, American Institute of Steel Construction, 1997 (Ref. 97)
	AISC 341-97 Supplement No. 2, American Institute of Steel Construction, 10 November 2000 (Ref. 98).
	AISC 1999 LRFD, Load and Resistance Factor Design Specification for Structural Steel Buildings, American Institute of Steel Construction, 1999 (Ref. 99)
	AISC Specification for Structural Steel Buildings - Allowable Stress Design (ASD) and Plastic Design 1989 (Ref. 100).

4 GDA STEP 4 NUCLEAR DIRECTORATE ASSESSMENT FOR CIVIL ENGINEERING AND EXTERNAL HAZARDS

4.1 Safety Case Documentation

4.1.1 Pre-construction Safety Report

165 The UK accepted practice is that the PCSR summarises the safety case for the whole station. It contains the claims made for the safety and operational functional requirements for each building or structure. As described in Section 3.1.1, the initial two versions of the PCSR submitted by Westinghouse did not meet regulator expectations. The subsequent rewrite of the PCSR (Ref. 1), which was received in December 2010, is a much more substantial document at 3408 pages compared with the 501 pages of the 2009 PCSR. However, I note that some of the text in Chapters 12 and 16 are taken directly from the EDCD.

166 I welcome Westinghouse's proactive approach in developing the PCSR throughout Step 4 and their intention to issue a consolidated PCSR.

4.1.2 European DCD

167 The EDCD contains a large amount of information. However, it mainly gives descriptions of structures and states that these structures will fulfil their safety and operational functional requirements without necessarily giving the full evidence.

168 The current version of the EDCD was submitted in December 2009. I note that some of the information contained within it has now been superseded by other documents and this has been noted in my report where appropriate.

4.1.3 Supporting Documents

169 The evidence submitted by Westinghouse to support claims made in their PCSR and EDCD is contained within a large number of secondary documents.

170 Westinghouse's approach is to use high level documents which are promoted as being applicable to civil structures across the site. I have found, however, that there are anomalies between high level and detailed calculations where the latter often has additional or revised design criteria which take precedence.

171 As noted in Step 3, the hierarchical structure between documents has not been readily apparent. Since the AP1000 (and previously the AP600) has been developed over the last 10 years, a considerable number of design basis documents have been produced. This means that the pertinent information is spread over a variety of documents with the potential for conflicts. Often text is repeated in several documents with subtle differences such that the final version adopted is not clear.

172 The configuration control of GDA submission documentation is a cross-cutting topic and has been raised as GDA Issue **GI-AP1000-CC-02**, see ONR's assessment report on Cross-cutting Topics, GDA-ONR-AR-11-016, Ref. 294.

4.2 Classification and Categorisation

4.2.1 Assessment

173 The SAPs applicable are ECS.1 and ECS.2, and paragraphs 148 to 156 and are the primary guidance to the assessment of safety categorisation. The SAPs link the selection

of design standard to safety categorisation. ECS.1 suggests, though not exclusively, three different levels of safety categorisation.

174 The AP1000 classification and categorisation of the buildings as submitted under GDA are described in Section 3.5 of this report. Westinghouse assigns a seismic design classification that is based on the UK safety class and category of the civil structure or building. Westinghouse has designated three seismic classes:

- Seismic class I (C-I) applies to function and integrity.
- Seismic class II (C-II) applies only to integrity.
- Non-nuclear seismic class (NNS) applies to all items not classified as C-I or C-II.

175 The Civil/Structural Design Criteria (Ref. 81) presents in Section 4.1 a list of civil structures and their seismic class. I note that this conflicts with the information from AP1000 UK Safety Categorisation and Classification of Systems, Structures and Components (Ref. 88) which is more recent and so the latter is taken as being correct.

176 Basically, all buildings housing Class 1 SSCs have a seismic class C-I and so are designed for the SSE. All buildings housing Class 2 SSCs have a seismic class NNS unless they could collapse directly onto C-1 structures, in which case they are designated C-II. All buildings that house Class 3 SSCs are NNS and so are designed for the UBC 2007 seismic provisions.

4.2.2 Split Seismic Classification for Turbine Building and Annex Building

177 Westinghouse's methodology allows a split seismic categorisation for a building. The last paragraph of Section 3.2 of the Westinghouse AP1000 Seismic Design Criteria document (Ref. 82) permits C-II to be limited to the parts of the structure, system or component where structural analysis shows a credible failure or interaction with C-I items.

178 The Turbine Building and the Annex Building both have split categorisations. Therefore, further evidence was sought that the Category NNS parts of the buildings had been designed such that they could not collapse onto or impair the function of the nuclear island when subjected to the Safety, Security and Environmental Report (SSER).

179 My assessment confirmed that the split parts of the buildings were distinctly different in structural layout and thus both the Turbine Building and the Annex Building could be thought of as two buildings in one. This means the two distinct parts of each building could be designed to separate codes and thus different categorisations could be applied.

180 To investigate how this was taken through to the detailed design, a deeper sample was made of the Turbine Building as described in Section 4.18.

4.2.3 NNS Classification of the Radwaste Building

181 The Radwaste Building has been classified by Westinghouse as NNS. This was queried in the Step 3 Assessment Report. During Step 4, technical queries TQ-AP1000-680 and 944 were raised, mainly to confirm design codes with respect to classification. However, these TQs confirmed Westinghouse's classification of the Radwaste Building as NNS.

182 Since the Radwaste Building has been taken out of scope by Westinghouse, its classification will need to be reviewed at the appropriate time.

4.2.4 Summary and Findings

183 My assessment confirms that the Westinghouse methodology for classifying structures broadly covers that defined in the SAPs. My main findings are described below.

184 Seismic class I structures (C-I) are designed for the SSER such that they remain functional during or following this design basis event. This is consistent with the UK definitions of Class 1 and Class 2 structures.

185 Seismic class II structures (C-II) are designed for the SSER such that they will not suffer unacceptable structural failure or interact adversely with seismic class I items.

186 NNS is used for structures which would be classed as Class 3 structures in the UK. Seismic loads are defined in accordance with the 1997 Uniform Building Code provisions (Ref. 90). UK Class 3 structures do not need to be designed for seismic loads; however they must be designed such that potential collapse during the design basis earthquake would not endanger Class 1 or Class 2 structures. Assessment of Westinghouse's method of achieving this is given in Section 4.2.2.

187 There are differences between the various documents with respect to how the third seismic class is labelled. This is referred to by either of the following three titles:

- Seismic class III;
- NS – non-seismic;
- NNS – non-nuclear seismic.

188 I am satisfied from my assessment that these terms all refer to the same classification. However, the documentation should be updated to ensure this confusion is not perpetuated. This is captured in the Assessment Finding below which must be completed prior to milestone 2 – first concrete.

AF-AP1000-CE-01: The licensee shall ensure that all civil documentation for the AP1000 uses the same nomenclature for Seismic Class NNS – non-nuclear seismic.

189 The classification of the Radwaste Building will need to be revisited once the building design is formally submitted. This is captured in the Assessment Finding below which must be completed prior to milestone 2 – first concrete.

AF-AP1000-CE-02: The licensee shall confirm the safety classification of the Radwaste Building, and provide justification for this.

4.3 Design Codes

4.3.1 AP1000 Codes and Standards

4.3.1.1 Assessment

190 The codes adopted by Westinghouse for the design and construction of seismic class I concrete and steel structures are acceptable (ACI 349 and AISC N690 respectively). However, it must be noted that these are not the current versions of these codes (refer to Section 4.3.2). The steel/concrete composite structures used for the Shield Building and the modules are not differentiated within the Civil/Structural Design Criteria document (Ref. 81), despite there being no relevant design codes for these structures. This is presumably because Westinghouse regards them as equivalent to reinforced concrete. My concerns about these structures are presented in Section 4.16.

- 191 Table 2 of the Civil/Structural Design Criteria document, APP-GW-C1-001 Revision 1 (Ref. 81) shows the association between seismic classification of civil structures and applicable codes. It is important to remember that, for this report, categorisation and classification are used in the UK sense and not the US approach, which features in quotes from Westinghouse documents. A footnote attached to Table 2 states that “*seismic category II structures shall be designed to the same methods and acceptance criteria as seismic category I structures. They may be constructed to the codes and standards for seismic category III structures*”. Furthermore, Section 6.2.1 states that “*seismic category II structures shall be designed for the design wind speed, for seismic loads and for seismic category I structure tornado loading. The design shall meet the requirements of ACI-349 for concrete structures and AISC-N690 for steel structures. However the structure is constructed to the same requirements as the non-seismic structures, ACI 318 for concrete structure and AISC-S335 for steel structures.*”
- 192 Further explanation was required as these statements give rise to concerns as to the appropriateness of the codes used for seismic class II structures. Three technical queries were raised; TQ-AP1000-680, 794 and 944.
- 193 TQ-AP1000-680 questioned the meaning of the quote from Section 6.2.1 of Ref. 81 in its entirety. The response from Westinghouse was unclear and so TQ-AP1000-794 was raised to question the Westinghouse definition of “design” and “construction” used. To summarise, the responses to TQ-AP1000-680 and TQ-AP1000-794 indicated that seismic class II structures are designed and constructed to non-nuclear codes; however the structures are analysed for the seismic, wind and tornado loading scenarios using the same code requirements as seismic Category I structures; that is nuclear code standards.
- 194 TQ-AP1000-944 was raised, questioning the application of nuclear and non-nuclear design codes and standards to the seismic class II structures. The response to TQ-AP1000-944 agrees with the current version of the primary supporting document, the Civil/Structural Design Criteria (Ref. 81), namely Section 6.2.1 and footnote to Table 2. Therefore, the responses to TQ-AP1000-680 and 794 are incorrect and I have discounted them.
- 195 TQ-AP1000-944 requested Westinghouse to supply a breakdown of which sections of the codes are used for each structure. Westinghouse’s response to this TQ was that “*AP1000 seismic category II structures are designed in accordance with ACI 349-01 and AISC N690-1994 with the supplemental requirements as identified in APP-GW-C1-001. The only portions of the codes that are not applicable to AP1000 Seismic Category II structures are the items related to quality assurance during the construction phase.*”
- 196 Chapter 8 of ACI 349-01 outlines the requirements for the analysis and design of concrete structures with Chapter 4 of ACI 318 detailing the construction requirements. Section 9.1.2 of ACI 349 states: “*Members also shall meet all other requirements of this Code to ensure adequate performance at normal load levels*”. This statement implies that members should be constructed to ACI 349 provisions.
- 197 Whilst the classification of the buildings is not in question, there are concerns with the application of nuclear and non-nuclear codes for seismic C-II structures. Where mixed codes have been used, care must be taken that the provisions of one code are not breached by the use of another code. No evidence was supplied that the construction methods employed by ACI 318 do not breach the design rules of ACI 349. The intention of raising TQ-AP1000-944 was to request a detailed breakdown of which sections of the respective codes are applied on a structure by structure basis.
-

198 I consider that the civil engineering documentation should include a complete listing of which sections are used from which code, e.g. whether the strength and serviceability requirements are taken from ACI 349 or ACI 318. This was the intention of raising TQ-AP1000-944. However, the response did not provide the necessary information. This is captured in the Assessment Finding **AF-AP1000-CE-03** below.

4.3.1.2 Findings

199 The following Assessment Finding has been raised on the application of design codes. This must be completed before milestone 2 – first concrete:

AF-AP1000-CE-03: *The licensee shall ensure that the relevant civil documentation for the AP1000 Class II structures is specific on which sections from which codes are used, on each structure or parts of a structure. For example, whether the strength and serviceability requirements for Class II structures are taken from ACI 349 or ACI 318. An appraisal of the sub-clauses should be performed to ensure that no rules have been breached by choosing a different construction code to the one used for design.*

4.3.2 Use of Superseded Codes and Standards

4.3.2.1 Assessment

200 This section comprises the assessment of codes, standards and industry specifications used by Westinghouse for the seismic analysis and design of the AP1000. The assessment is based on ECS.3 and paragraphs 158 and 159 of the SAPs (Ref. 4).

201 The primary codes and standards used by Westinghouse are listed in Table 7 in Section 3.6. A detailed examination of these codes by Arup (Ref. 34) revealed that:

- only ASCE Standard 4-98 is current, although an update is planned and there is a new draft in preparation (Ref. 71); and
- all others listed have been either withdrawn or superseded and replaced by more recent editions as shown in Table 8.

202 The 1997 Uniform Building Code (Ref. 90) ceased to be a legal building code on 1 January 2008 when the State of California adopted the 2006 International Building Code (IBC) thereby completing the process of adoption of the IBC in all jurisdictions of the US including the 50 states, Washington DC and the US overseas territories. The current edition of the IBC is the 2009 edition (Ref. 101).

203 TQ-AP1000-970 was raised to request Westinghouse to provide justifications for use of the superseded codes, standards and industry specifications or alternatively to demonstrate that the current design of the AP1000 civil and structural works meet the requirements of the equivalent current editions. Westinghouse's response to TQ-AP1000-970 acknowledged that this question spans across multiple GDA topics. Their approach is to demonstrate that the AP1000 codes, standards and industry standards meet engineering principles ECS3, ECS.4 and ECS.5 of the SAPs.

204 This demonstration is documented in the AP1000 Equivalence/Maturity Study of the US Codes and Standards, UKP-GW-GL-045 (Ref. 77). This study reviewed only the following four civil engineering standards:

- ACI 349-01, Code Requirements for Nuclear Safety Related Concrete Structures. 2001. (Ref. 22).
- ASCE 7-98, Minimum Design Loads for Buildings and Other Structures. 1998 (Ref. 91).
- ASCE 4-98, Seismic Analysis of Safety-Related Nuclear Structures and Commentary. 1998. (Ref. 92).
- AISC N690-94, Specification for the Design, Fabrication, and Erection of Steel Safety-Related Structures for Nuclear Facilities. 1994. (Ref. 96).

Table 8

Superseded Standards

AP1000 Code (refer to Table 7)	Superseded by
International Conference of Building Officials, 1997 Uniform Building Code, 1997 (Ref. 90)	IBC-06 International Building Code, 2006 subsequently superseded by IBC-09 International Building Code, 2009 (Ref. 101)
ASCE Standard 7–98, Minimum Design Loads for Buildings and other Structures, American Society of Civil Engineers, 1998 (Ref. 91)	Current standard ASCE 7-10 (Ref. 102) (interim versions ASCE 7-02 and ASCE 7-05)
ASCE Standard 4–98, Seismic Analysis of Safety-Related Nuclear Structures and Commentary, American Society of Civil Engineers, 1998 (Ref. 92)	New update currently in draft (Ref. 103)
ACI 349–01 Code Requirements for Nuclear Safety related Concrete Structures and Commentary (Ref. 22)	ACI 349-06 (Ref. 104) and ACI 349.1R-07 Reinforced Concrete Design for Thermal Effects on Nuclear Power Plant Structures (Ref. 105). New update currently in draft (Ref. 106)
ACI 318–99, Building Code Requirements for Structural Concrete, American Concrete Institute, 1999 (Ref. 93)	ACI 318-02 (Ref. 107) New update currently in draft.
ACI 301-05 Specification for Structural Concrete for Buildings 2005 (Ref. 94)	ACI 301-10 (Ref. 108)
AISC N690–1994 Specification for the Design, Fabrication, and erection of Steel Safety-related Structures for Nuclear Facilities (including Supplement No. 20). American Institute of Steel Construction. 1994. (Ref. 96)	AISC N690-06 (Ref. 109). An update is planned for 2012 for a new Appendix N9 which is currently in draft titled Specification for Modular Composite Walls and Slabs in Safety-Related Structures and Nuclear Facilities (Ref. 110)
AISC 341-97, Seismic Provisions for Structural Steel Building Buildings, American Institute of Steel Construction, 1997 (Ref. 97) and supplement No.2 (Ref. 98)	AISC 341-02 (Ref. 111) and further superseded by AISC 341-05 (Ref. 112)

Table 8
Superseded Standards

AP1000 Code (refer to Table 7)	Superseded by
AISC 1999 LRFD, Load and Resistance Factor Design Specification for Structural Steel Buildings, American Institute of Steel Construction, 1999 (Ref. 99)	AISC 360-05 Specification for Structural Steel Buildings. American Institute of Steel Construction (AISC) 9 March 2005 (Ref. 113); and further superseded by AISC 360-10 (Ref. 114).
AISC Specification for Structural Steel Buildings - Allowable Stress Design (ASD) and Plastic Design 1989 (Ref. 100).	

- 205 The conclusions given by Westinghouse on ACI 349-01 versus ACI 349-06 (Ref. 77) is that the *“changes between them are minor and the AP1000 could be expected to comply with the revised standard.”* The statement is also made that ACI 349-01 is considered to be in accordance with UK and European best practice.
- 206 The standard used for structural steelwork design of the AP1000 is AISC N690-1994. The study concludes that this has been *“incorporated into AISC N690-2006. While allowable strength design is still permitted in the new standard, some safety factors have been increased to bring reliability into line with load and resistance factor design. As a result, design to AISC N690-1994 is generally in accordance with current best practice requirements. The existing design will only comply with the current standard:*
- *If it exceeds the requirements of the 1994 standard by a sufficient margin, which varies from 0 to 25% according to the load effect considered, and*
 - *If it adopts good seismic detailing consistent with AISC 341 when designing for inelastic behaviour.”*
- 207 ASCE 7-1998 has been superseded by the 2010 edition (Ref. 102). The study concludes that the wind and snow loading provisions of ASCE 7-1998 are adequate for the AP1000 building arrangements. Comparison is made with UK standards and it is noted that tornado loading is not covered by these.
- 208 ASCE 4-1998 is still current. The study compares it with BS EN 1998 (Eurocode 8) (Ref. 115), although this is not a nuclear code. The study concludes that *“the application of ASCE 4-98 in the AP1000 design documentation represents current UK best practice. No concerns with the application of ASCE 4-98 have been identified.”*

4.3.2.2 Summary and Findings

- 209 I consider the persistence in using superseded standards as falling short of current good practice. Although I recognise the development of the AP1000 to have been over 20 years, it could be expected that current standards would be used for such a high integrity facility as a nuclear power plant. However, the UK Regulatory framework is different from the US in that we require a periodic safety review (PSR) every 10 years throughout the lifetime of the facility. The purpose of the PSR is to review developments in design codes and practices to ensure a facility, once built, will still perform satisfactorily in line with

current thinking. This review can result in subsequent modifications to structures to ensure appropriate compliance.

210 The maturity study has considered just four standards. I generally accept the findings, but have found in deeper samples within my assessment that there are code differences which could affect the design. These are described in the appropriate sections and raised as Assessment Findings or GDA Issues accordingly.

211 The study's conclusion on the existing design being potentially up to 25% non-conservative with respect to AISC N690-2006 is of concern. This will require further justification during nuclear site licensing.

212 Since the construction of an AP1000 in the UK may be some years away, I have raised the following Assessment Findings on the licensee to perform a code comparison prior to milestone 2 – first concrete.

AF-AP1000-CE-04: *The licensee shall ensure that evidence is generated to ensure that the proposed codes and standards for the AP1000 are adequate to support design, procurement, installation, operation, and subsequent EMIT activities. The licensee should also ensure that the AP1000 codes and standards meet applicable UK Health and Safety legislation, including regulations as appropriate.*

AF-AP1000-CE-05: *The licensee shall make and implement adequate arrangements to ensure that the AP1000 NPP design for the UK takes account of subsequent changes to applicable codes, standards, and legislation.*

4.4 External Hazards

4.4.1 Introduction

213 The AP1000 is a standardised plant allowing a commonality matrix of external hazards to be developed. Where external events are judged to be non-site-specific, a generic site envelope has been developed by Westinghouse outlining the characteristics against which all plants will be designed.

214 Westinghouse's expectation is that licence applicants referencing the standard AP1000 design, will provide site-specific information related to site location and description and population distribution. The acceptability of external accidents associated with a given site will have to be covered in the licence application.

215 The first key step in addressing the threats from external hazards is to identify those that are of relevance to the facility under consideration. This process is normally undertaken once a physical location for the facility has been established. However, for the GDA process, this is not the case. Hazards fall into one of the following categories:

- Hazards which will be present on all sites and for which a design value has been estimated. This design value may be compared to the prevailing site conditions in the UK to establish its reasonableness.
 - Hazards which will be present on all sites, but the magnitude of which cannot be determined until a site has been selected, i.e. flooding, industrial hazards.
 - Hazards which may be present on a site but this cannot be established until a site has been selected.
-

4.4.2 Assessment Approach

216 My assessment of the Westinghouse external hazards safety case is in three parts.

- Firstly, as a result of findings from the Step 3 Assessment, the Westinghouse methodology for hazard selection and screening has been assessed in some detail as there was insufficient information provided at Step 3 to form a view.
- Secondly, the individual external hazards against which the generic plant has been designed are assessed. However, whilst the generic design parameters are considered in this assessment, nuclear safety will need to be assessed on a site specific basis when the site specific hazard information is available for each site.
- Thirdly, the method of application and combination of hazard loadings in the design of the civil structures is also assessed.

217 SAPs EHA.1 to EHA.17 (Ref. 4) relate to external hazards that could have a detrimental effect on nuclear safety. These SAPs include the following three engineering principles which are applicable to both external and internal hazards:

Engineering principles: external and internal hazards	Frequency of exceedance	EHA.4
The design basis event for an internal and external hazard should conservatively have a predicted frequency of exceedance in accordance with the fault analysis requirements (FA.5).		

Engineering principles: external and internal hazards	'Cliff-edge' effects	EHA.7
A small change in DBA parameters should not lead to a disproportionate increase in radiological consequences.		

Engineering principles: external and internal hazards	Extreme weather	EHA.11
Nuclear facilities should withstand extreme weather conditions that meet the design basis event criteria.		

218 SAP EHA.4 defines the frequency of exceedance for a UK design basis event that should conservatively have a predicted frequency of not greater than 1.0E-04/yr, i.e. a frequency equivalent to a 1-in-10,000 year event.

219 A UK design basis assessment requires a deterministic analysis of an internally initiated event that is expected to occur more frequently than 1.0E-05 per year. Any event that occurs less frequently than this is regarded either as beyond design basis or, if its frequency is less than 1.0E-07 per year, as incredible. Specifically, SAP EHA.1 Paragraph 212 states that any generic type of hazard with a total frequency that is demonstrably below once in ten million years, i.e. less than 1.0E-07 per year, may be excluded.

4.4.3 Documentation

- 220 For GDA Step 4 the Westinghouse safety case for external hazards is essentially contained within the following documents;
- AP1000 Pre-construction Safety Report UKP-GW-GL-732 Revision 2, (Ref. 10).
 - AP1000 External Hazards Topic Report, UKP-GW-GL-043 Revision 0. (Ref. 75).
 - European Design Control Document. EPS-GW-GL-700 Revision 1. (Ref. 67).
 - AP1000 Categorisation and Classification Methodology, UKP-GW-GL-044 Revision 1. (Ref. 76).
 - AP1000 Categorisation and Classification of Systems, Structures and Components, UKP-GW-GL-144 Revision 1. (Ref. 88).
- 221 Additionally, during the course of the Step 4 assessment period, Westinghouse has updated the Pre-construction Safety Report and issued a new draft UKP-GW-GL-793 Revision A, December 2010 (Ref. 1). Chapters 12 – external hazards and Chapter 16 – civil engineering provide relevant useful information.
- 222 All the above documentation includes identification of several hazards that can only be fully quantified when specific sites are identified, such that the hazards can be addressed on a site specific basis.

4.4.4 Site Parameters

- 223 A review of the bounding site parameters across the reports by ABS Consulting (Ref. 24) found minor discrepancies between the following tables:
- Table 3-1 of the 2009 PCSR (Ref. 10).
 - Table 6-2 of the External Hazards Topic Report (EHTR) (Ref. 75).
 - Table 2-1 of the EDCD (Ref. 67).
- 224 Westinghouse has undertaken to correct these in the next version of the AP1000 External Hazards Topic Report and in the new consolidated PCSR. All other bounding parameters are consistent across all three documents. The generic site parameters are summarised in Table 9 in Section 4.4.5 of this report.
- 225 The geological conditions that apply to the AP1000 design are summarised in Section 2.5 and Table 2-1 of the EDCD. Westinghouse states that the specific ground conditions at sites in the UK would need to be confirmed by site-specific ground investigation to confirm the adequacy of the soil for compliance with the AP1000 design parameters. Where these fall outside the given specifications, justification on a site-specific basis would have to be undertaken by the licence applicant. The AP1000 plant has also not been specifically designed to account for either ground rupture or liquefaction effects.
- 226 Westinghouse states that licence applicants will be required to address the following regional and site-specific geological, seismological and geophysical information, as well as conditions caused by human activities:
- Structural geology of the site.
 - Seismicity of the site.
 - Correlation of earthquake activity with seismic sources.

- Seismic wave transmission characteristics of the site.
- Geological history.
- Evidence of paleoseismicity.
- Site stratigraphy and lithology.
- Engineering significance of geological features.
- Site groundwater conditions.
- Dynamic behaviour during prior earthquakes.
- Zones of alteration, irregular weathering, or structural weakness.
- Unrelieved residual stresses in bedrock.
- Materials that could be unstable because of mineralogy or unstable physical properties.
- Effect of human activities in the area.

227 Although the cooling water structures are not included in GDA, I note that the generic site assumes these will be cooling towers rather than sea water cooling. Section 12.10.1.2 of 2010 PCSR states that “*The AP1000 UK design envisages the SWS will be served via cooling towers to act as a heat sink and is therefore not based on sea/estuary water cooling. Consequently the SWS is dependent on ambient air temperature rather than sea temperature*”. As the AP1000 design only envisages cooling towers, the use of sea water cooling may still be an option and therefore this is still considered to be a site specific issue.

4.4.5 External Hazard Selection and Screening Methodology

228 Chapter 12 of the 2010 PCSR (Ref. 1) contains specific supporting information on the nuclear safety withstand of the AP1000 design in response to design basis external hazards. The definition of an external hazard as applied in this chapter is a natural or man-made hazard that is initiated from outside the AP1000 plant site boundary. Westinghouse note that the HSE SAPs specify that the effect of external hazards on nuclear facilities be identified and considered in the safety assessments and aim to meet the SAP requirements. The safety assessment should demonstrate that risks from the external hazards are removed, minimised or are tolerable. This is claimed to be done by showing that necessary plant and equipment are designed to meet appropriate performance criteria against the postulated hazard.

229 Westinghouse describes the hazard grouping and screening process in Section 12.5 of the 2010 PCSR with detailed analysis given in Table 12-1 and Table 12-2. These tables identify the external hazards grouping for man-made and naturally occurring hazards respectively. Some external hazards, such as volcanic action, meteorite and asteroid activity, have been screened out because of their low frequency. Hazards, such as fog and mist, have also been excluded because their effect will have no direct impact on the safety of the facility.

230 For each hazard category, the potential source(s) of the hazards are identified. For identified hazard source(s), postulated initiating events that could result from the source(s) are cited. The initiating events in Tables 12-1 and 12-2 have been compiled by Westinghouse primarily from the HSE guidance and International Atomic Energy Agency (IAEA) sources. Table 12-2 provides definitions of some of the cited hazards. Table 12-1

and Table 12-2 identify the potential consequences of initiating events and the safety features in place to mitigate the consequences.

231 For each initiating event, one of the following six outcomes is stated:

- i) The initiating event is addressed in Chapter 12 of the PCSR.
- ii) The initiating event can be screened out because of a low probability of occurrence or negligible consequences.
- iii) It can be bounded by another initiating event.
- iv) The initiating event can be considered under another hazard grouping.
- v) The initiating event is specific to a site and consequently requires site-specific information and will be considered in a site-specific PCSR.
- vi) The initiating event (e.g. fire) is addressed as part of Internal Hazards as described in Chapter 11 of the 2010 PCSR.

232 After the screening process, the identified groups of hazards were reduced to 11 generic external hazards categories as shown in Table 9.

Table 9
AP1000 Bounding Site Parameters

Parameter	Type	Value
Seismic	Operating Basis Earthquake	Not used, since SSE used as design basis.
	Safe Shutdown Earthquake	0.30g peak ground acceleration (PGA)
	Fault Displacement Potential	Negligible
External Flooding	Site specific	Design basis for maximum flood level for 1 in 10,000 year event.
Accidental aircraft crash	Site specific	Based on probabilistic assessment of the site.
External explosion	Site specific	Not assessed for GDA.
Air Temperature	Maximum Safety	46.11°C (115°F) dry bulb
		30.06°C (86.1°F) coincident wet bulb
		30.06°C (86.1°F) wet bulb (non-coincident)
	Minimum Safety	-40°F (-40°C)
	Maximum Normal	101°F (38.33°C) dry bulb
	Minimum Normal	-10°F (-23.33°C)
Meteorology	Rain	525.8 mm (20.7inch)/hr (160.0 mm (6.3 inch)/5 min)
	Snow	3.0kN/m ² (63psf) uniform snow load Additional drift loads calculated separately.

Table 9
AP1000 Bounding Site Parameters

Parameter	Type	Value
Wind Speed	Operating Basis	64.82 m/sec (145 mph) (3 second gust); importance factor 1.15 (safety), 1.0 (non safety); exposure C; topographic factor 1.0
	Tornado	134.11 m/sec (300 mph)
Offsite fire and smoke	Site specific	Not assessed for GDA.
Offsite missiles	Site specific	Not assessed for GDA.
Biological fouling	Site specific	Mainly affects cooling water structures
Electromagnetic interference (EMI) and lightning	Site specific	Lightning protection is provided. EMI will need to be assessed at site specific stage.

4.4.6 Hazards Subjected to Westinghouse Detailed Review

4.4.6.1 Introduction

- 233 Eleven generic external hazards categories are assessed by Westinghouse against the Class 1 SSCs of the AP1000 Nuclear Island to ensure that they do not prevent the delivery of Category A safety functions.
- 234 The eleven hazards identified as requiring detailed consideration are discussed in the following section.

4.4.6.2 Earthquake

- 235 The AP1000 plant is designed for an earthquake defined by a peak ground acceleration (PGA) of 0.3 g horizontally and vertically. The AP1000 design earthquake is referred to as the certified seismic design response spectra (CSDRS). Figures 3.7.1-1 and 3.7.1-2 of the EDCD (Ref. 67) depict the horizontal and vertical design response spectra for the AP1000 plant, scaled to the SSE at 0.3 g. The design response spectra (RS) are applied at foundation level in the free field at hard rock sites and at finished ground level (100 m) in the free field at firm rock and soil sites. Westinghouse claims this can be compared to the UK PGA values.
- 236 Westinghouse observes that UK seismic RS have typically been based on the Principia Mechanics Ltd (PML) derived spectra, which are appropriate for typical forms of building construction. The PML spectra address three generic types of site ground conditions: hard (frequency of soil column > 5Hz), intermediate (frequency of soil column in the range 2 to 5 Hz) and soft (frequency of soil column < 2 Hz). A number of UK nuclear-licensed sites have undertaken a site-specific seismic hazard to determine appropriate free field horizontal peak ground acceleration (PGA) at their location. Westinghouse notes that it is accepted UK practice that the maximum value this can achieve in the UK is 0.25 g for a 1-in-10,000 year earthquake. The vertical spectrum is usually taken as two-thirds of the horizontal value. However, where the building mass is significant in comparison to the

mass of the soil volume (such as for heavy shielding associated with reactor buildings), the PML spectra may not be appropriate and soil-structure interaction on a site-specific, case-by-case basis is normally undertaken to evaluate the response of the system.

237 Appendix 3G of the EDCD presents the spectra for the NI structures for the six soil profiles considered by Westinghouse (i.e. hard rock, firm rock, soft rock, upper-bound soft-to-medium soil, soft-to-medium soil and soft soil) derived from the soil-structure interaction analyses for the NI buildings. The frequencies for rock and medium and soft soil columns have been determined from the shear wave velocities cited in Section 3G.3 of the EDCD.

238 The applicability of these six sites to UK conditions is discussed further in Section 4.10.

4.4.6.3 External Flooding

239 Flooding is dealt with as a site specific issue. The generic PCSR considers the 1 in 10,000 year flood level to be at or below the assumed ground level or grade elevation. Therefore Westinghouse assumes that, for a specific site, the grade elevation will be at the maximum flood level or higher, or the ground levels will be raised to achieve this.

240 For structural analysis purposes, the site datum is assumed to be at a ground floor level of 100m, with grade being defined as the ground level within a half-mile radius of the NI. Actual ground levels will be a few centimetres lower and sloped away from buildings to prevent surface water from entering doorways. The AP1000 reactor is designed for a normal groundwater elevation up to plant elevation 99.39m and for a flood level up to a plant elevation of 100m.

241 Flooding of the NI above ground floor level, thus inducing internal flooding, is therefore claimed as beyond design basis. As there are no Class 1 SSCs outside the NI, Westinghouse states that flood-induced damage outside the NI will not prevent the delivery of Category A safety functions. Therefore at the time of site licensing, the licensee will need to demonstrate that the ground floor of the NI is above the probable maximum 1 in 10,000 year flood level. This maximum flood level must account for flooding of streams and rivers, potential dam failures, probable maximum surge and tsunami flooding. This shall be resolved as part of AF-AP1000-CE-06 and 07 detailed below.

4.4.6.4 Aircraft Crash

242 Refer to Section 4.6.

4.4.6.5 External Explosion

243 Westinghouse argues that this is a site specific issue and so it has not been included in its GDA submission.

4.4.6.6 Extreme Ambient Temperatures

244 The air temperatures considered in the AP1000 design are given in Table 9 in Section 4.4.5 of this report. My assessment has concluded these are appropriate, although the licensee will need to prove that these bound site specific parameters.

4.4.6.7 Meteorology

245 The design values for rain and snow considered in the AP1000 design are given in Table 9. My assessment has concluded these are appropriate, although the licensee will need to demonstrate that these bound site specific parameters.

4.4.6.8 Wind

246 The wind and extreme wind (tornado) considered in the AP1000 design are given in Table 9. My assessment has concluded these are appropriate, although the licensee will need to prove that these bound site specific parameters.

4.4.6.9 Climate Change

247 Westinghouse states that, where appropriate, climate change in the form of increased sea levels, precipitation and ambient temperatures, etc have been considered based on United Kingdom Climate Projections 2009 (UKCP09) (Ref. 116). The climate change projections considered here are the maximum published projections to the year 2080 and therefore include the 60-year design operating life of the AP1000 plant, although no period for post operation is included. The effect of climate change post-operation, when the plant is being decommissioned, will need to be considered by the licensee when appropriate climate change data becomes available.

4.4.6.10 Offsite Fire and Smoke

248 Westinghouse argues that this is a site specific issue and has not included it in its GDA submission.

4.4.6.11 Offsite Missiles

249 Westinghouse argues that this is a site specific issue and has not included it in its GDA submission.

4.4.6.12 Biological Fouling

250 Westinghouse argues that this is mainly applicable to cooling water intakes. This is a site specific issue and has not been included in its GDA submission.

251 I sought confirmation that protection had been given to the external openings in the Shield Building, i.e. the air intakes and central roof vent. Westinghouse has provided screens over these openings to prevent ingress of birds or debris inside the Shield Building. I did not sample further in terms of suitability of the mesh, but am satisfied that this aspect has been appropriately considered by Westinghouse.

4.4.6.13 Electromagnetic Interference (EMI) and Lightning

252 The EDCD states that the AP1000 is provided with lightning protection. I did not sample in more detail since this is a straight forward engineering design requirement of all new buildings.

253 Interference from electromagnetic sources off site has been identified by Westinghouse as only capable of detailed consideration once a site has been chosen.

4.4.7 Load Schedule Application

254 The third element of my assessment of external hazards was an overview of the load schedule application, used in the design of civil engineering structures, and a deep sample of certain structures. The details of these assessments are presented in later sections of this report for each building.

255 This has been achieved by reviewing the relevant design documentation for the following:

- Derivation of applied loads from identified external hazards and load combinations thereof.
- Consideration of these load applications in the design process for each of the identified structures, focusing on the structural load paths and failure modes identified.
- The structural analyses performed in support of the design process, focusing on methodology, assumptions and validation.
- Output from the structural analyses, e.g. extraction of member loads, subsequent assessment of members, calculated margins/reserve factors.

256 A deep sample of the design support documentation/analyses/calculations was performed by ABSC (Ref. 27) for the following identified individual structures.

- Auxiliary Building
 - Shear wall 7.3 assessment of load combinations.
 - Area 3 of the Auxiliary Building RC roof connection to the cylindrical Shield Building SC wall.
 - West side wall of Spent Fuel Pond Area, CA20, between the spent fuel pond and fuel transfer canal.
- Containment Internal Structures
 - Hydrodynamic pressure on steel wall of in-containment refuelling water storage tank (IRWST).
 - Review of Concrete Load Case 03 Combination Methodology.
 - Assessment of Seismic Sloshing Methodology.
- Turbine Building
 - Interaction between concrete seismic Category II First Bay and the remainder of the seismic Category III steel structure.
 - Interaction between the First Bay of the Turbine Building and the NI.
 - Assessment of Potential Collapse of Main Turbine Building against First Bay.

4.4.8 Summary and Findings

257 The method for the identification and screening of external hazards has not been apparent during the Step 4 assessment. However, the resulting screened list of design basis events used in the AP1000 design is considered reasonable.

- 258 The magnitude of the external hazards used as design basis events are seen as reasonable for typical UK sites. However, this will require much more detailed review at site licensing stage, and is captured in AF-AP1000-CE-06, 07 and 08 below.
- 259 The range of soil conditions used in the seismic design of the generic AP1000 is considered broadly representative of most UK sites. However, this will require much more detailed review at site licensing stage. This is discussed further in later sections of this report including particular findings for seismic design.
- 260 A series of Assessment Findings have arisen, as detailed below, which will need to be addressed prior to milestone 2 – first concrete.

AF-AP1000-CE-06: *The licensee shall derive hazard magnitudes for those hazards identified as only capable of evaluation on a site specific basis, including external flooding, accidental aircraft crash, external explosion, offsite fire and smoke, offsite missiles, biological fouling and electromagnetic interference.*

AF-AP1000-CE-07: *The licensee shall confirm that the magnitude of all external hazards considered generically envelope those for the particular site under consideration.*

AF-AP1000-CE-08: *The licensee shall confirm that, for any structure designed using generic site data, this data is enveloped for the particular site under consideration. This shall include, as a minimum, design loads and load combinations applied to the design and final detailing including proprietary items.*

4.5 Internal Hazards

4.5.1 Assessment

- 261 The schedule of loads that civil structures need to be designed for is built up from:
- 1) static loads, e.g. dead, live, water storage
 - 2) loads from external hazards
 - 3) loads from internal hazards.
- 262 Assessment of the Internal Hazards is covered by a separate assessment report, ONR-GDA-AR-11-001 (Ref. 35).
- 263 The Westinghouse internal hazard barrier matrix is given in APP-1000-GEC-004 Revision A (Ref. 87). This should list all the civil structures, e.g. walls and floors that are subject to loads from internal hazards such as:
- accident pressure;
 - accident thermal reactions;
 - accident pipe reactions;
 - jet impingement and thrust;
 - pipe impact;
 - dropped loads and impacts.
- 264 The Internal Hazards assessment (ONR-GDA-AR-11-001, Ref. 35) has raised queries with respect to the barrier matrix and substantiation of the loads on civil structures. The safety case for internal flooding needs further substantiation. Westinghouse claims that the loads from pipe rupture, blast pressure and internal missiles are bounded by the fire

hazard. ONR-GDA-AR-11-001 has concluded that this claim is not appropriate and so further substantiation is required under the IH GDA Issues listed below.

- **GI-AP1000-IH.01** for internal flooding (Ref. 52).
- **GI-AP1000-IH.02** for internal fire (Ref. 53).
- **GI-AP1000-IH.03** for pressure part failure (Ref. 54).
- **GI-AP1000-IH.04** for internal explosion (Ref. 55)
- **GI-AP1000-IH.05** for internal missiles (Ref. 56).

265 Westinghouse also claims that dropped loads will be prevented by using single failure cranes and lifting hoists. The Internal Hazards assessment (Ref. 35) has concluded that dropped loads could still occur, even using a single failure crane, due to human error or rigging failures. Therefore, a detailed quantitative analysis has been requested of the consequences of dropped loads on safety significant SSCs. This is captured under the following GDA issue:

- **GI-AP1000-IH.06** for dropped loads and impacts (Ref. 57).

266 My assessment has progressed on the basis that the civil structures load schedule is correct with respect to internal hazards and has focused on how this has been applied. However, if the outcomes of the above IH GDA issues result in changes to the load schedule, these will obviously need to be reviewed at the time.

4.5.2 Findings

267 The internal hazards assessment has identified shortfalls in the AP1000 internal hazards barrier matrix and the demand on the civil structures. I therefore raise the following Assessment Finding which must be addressed before long lead items are procured (milestone 1).

***AF-AP1000-CE-09:** The licensee shall take account of any implications of the outcomes of the Internal Hazards GDA issues which could affect the design of civil structures, particularly the loads, load combinations and serviceability requirements applied in the design.*

4.6 Aircraft Impact Protection

4.6.1 Scope

268 The AP1000 Class I structures, i.e. the Shield Building and the Auxiliary Building, are designed for potential commercial and military aircraft impacts. This includes both accidental and malicious aircraft crashes.

269 The cylindrical wall of the Shield Building was originally reinforced concrete, but was enhanced specifically for aircraft impact by adopting SC construction for those areas not enclosed by the Auxiliary Building. The external walls to the Auxiliary Buildings are substantial reinforced concrete walls, and so protect the lower part of the Shield Building.

270 Westinghouse has confirmed that the systems important for the safe operation and shutdown of the reactor, are contained within the class I buildings. The response to RO-AP1000-038 on the Diesel Generator Building has justified that the two generators do not need to be physically separated since they are not required for safe shutdown. This has been assessed under the Electrical Systems topic area (Refer to ONR-GDA-AR-11-007,

Ref. 45). A GDA issue has been raised, GI-AP1000-EE-01 (Ref. 58), to request substantiation of this claim.

271 My review of the aircraft impact assessment carried out by Westinghouse has been supported by specialists in impact analysis and assessment (Arup) and is reported separately.

4.6.2 Assessment

272 Accidental aircraft impact can be assessed by calculating the frequency relationship between the likelihood of impact and the nature of the aircraft.

273 Section 12.8 of the 2010 PCSR considers the probabilistic threat to the AP1000 plant from accidental aircraft impact. For malicious impact, this is not practicable and a deterministic approach is required. The nature of malicious threat is not discussed further in this report.

274 Westinghouse states that on a site specific basis *“the probability of an accidental aircraft impact should be demonstrated to be acceptably low because of the regulatory and administrative arrangements that prohibit aircraft access close to UK nuclear power station sites. UK air navigation regulations restrict flying in the vicinity of UK nuclear sites. All of the designated UK nuclear new build sites with either an existing or a decommissioned nuclear power plant have over-flying restricted to a height above 2000 feet and a radius greater than two nautical miles.”*

275 *Assuming the facility is not located within 5 miles of an airfield or close to a flight path (which is not allowed by legislation as previously described), the combined crash rate for light, small and large transport, helicopters and military combat aircraft is 4.8E-07 and 51.3E-07 crashes per year for the NI and the AP1000 generic site, respectively.”*

276 Westinghouse states that *“it should be confirmed on a site-specific basis that the generic background crash rate and the UK legislation that restricts flying in the vicinity of UK nuclear sites are applicable to the designated AP1000 plant site.”*

277 The following SAPs apply:

Fault analysis: severe accident analysis	Fault sequences	FA.15
Fault sequences beyond the design basis that have the potential to lead to a severe accident should be analysed.		

“547 *A best estimate approach should normally be followed. However, where uncertainties are such that a realistic analysis cannot be performed with confidence, a conservative or bounding case approach should be adopted to avoid optimistic conclusions being drawn.”*

Fault analysis: severe accident analysis	Use of severe accident analysis	FA.16
The severe accident analysis should be used in the consideration of further risk-reducing measures.		

278 Westinghouse has carried out an aircraft impact assessment of the Shield Building and the Auxiliary Building using the computer program LS-DYNA. This has been carried out according to NEI 07-13 Revision 7 - *Methodology for Performing Aircraft Impact Assessments and Large Explosion Assessments for New Plant Designs* (Ref. 117) - which is the standard recognised by the US NRC for aircraft impact assessment. The direct and indirect effects of potential aircraft impacts have been considered.

279 The doors and openings through these layers of protection have been considered in my assessment at a high level in terms of position and general specification. However, the final product selection will need to be assessed in detail once a supplier is appointed. This, therefore, is captured under **AF-AP1000-CE-08** in Section 4.4.8, under final detailing, including proprietary items.

4.6.3 Findings

280 The approach to protection of the AP1000 against aircraft impact has been found to be broadly satisfactory. The following observations are made:

- The NEI 07-13 standard is accepted for the methodology.
- The finite element code used is applicable and the analyses have been carried out appropriately.
- The loading functions and scenarios associated with military and commercial aircraft impact are appropriate.
- The analyses undertaken for military and commercial impact are applicable and satisfactorily predict the loads and displacements within the structures.
- The key claims on the ability of the nuclear island to provide sufficient aircraft protection against the loss of key safety functions has been found to be satisfied.

281 The probabilistic study of accidental aircraft impact will need to be examined in more detail on a site specific basis, to verify the frequency of accident is not exceeded. This is covered by the Assessment Finding below which is to be resolved by milestone 3 – NI safety related concrete.

AF-AP1000-CE-10: The licensee shall undertake a probabilistic study of accidental aircraft impact for the specific site application.

4.7 Materials

4.7.1 Assessment

4.7.1.1 General

282 The Westinghouse AP1000 GDA submission and the civil engineering standards that it references, typically refer to construction materials conforming to ASTM (American Standard for Testing and Materials), ANSI (American National Standards Institute) or AWS (American Welding Society) requirements. Construction materials in the UK are predominately in accordance with European (EN) specifications.

283 The Civil/Structural Design Criteria Revision 1 (Ref. 81) states in Section 7 the general materials to be used. It should be noted that Ref. 81 is a general specification and my assessment has highlighted material changes for specific structures, such as the Shield

Building (Ref. 72) and the CA Modules (Ref. 86). The materials used, as included in this assessment, are summarised in Table 10 below.

Table 10
AP1000 Materials

Material	Class I	Class II and III
Concrete	ACI 349 and ACI 301 f'c = 4000psi generally Shield Building, f'c = 6000psi ⁽¹⁾ CA Modules, f'c = 4000psi ⁽²⁾ Self consolidating concrete to be used in areas of congestion.	ACI 318 and ACI 301 f'c = 4000psi
Reinforcing Steel	ASTM A615 Grade 60	same as Class I
Tie Bars	Shield Building - ASTM A496 ⁽¹⁾	n/a
Structural Steel	Grade 50 to ASTM A572 general applications to ASTM A36	same as Class I
	CA Modules – Wall plates - ASTM A572 Grade 60 Steam cavities - ASTM 588 ASTM A36 generally	n/a
Stainless Steel	Type 304-L to ASTM A240	same as Class I
	CA Modules – Duplex 2101 produced by Outokumpu ⁽³⁾	n/a
Steel Bolts	High Strength ASTM A490 or A325 ASTM A307 for minor structures, e.g. stairs, ladders, purlins	same as Class I
Anchor Bolts	ASTM F1554 36ksi normal 105ksi where higher strengths required	same as Class I
Welds	E70XX or equivalent for ASTM A36 E308L-16 or equivalent for ASTM A240 type 304-L stainless steel	same as Class I
Formed Metal Deck	ASTM A611 Grade C	same as Class I
Steel Studs	ASTM A-108	same as Class I
Durbar Plate	ASTM A786 "rolled steel floor plates"	same as Class I
Grating	Welded galvanised "metal bar type" ANSI/NAAMM MBG 531-00 and 532-00	same as Class I
Gypsum Board	For non-structural walls	same as Class I

Notes on Table

1) from Section 2.5, ESB Design report (Ref. 72)

2) from APP-GW-SUP-001 (Ref. 86)

3) The stainless steel to be used for the CA Modules has been changed from Nitronic 33 as stated in Civil/Structural Design Criteria (Ref. 81) to Duplex 2101.

284 The difficulty of using a general civil/structural design criteria document to specify materials is that it will always be superseded by the detailed documents for each structure, as shown by notes 1), 2) and 3) on the above Table 10. Therefore, there is uncertainty in its current status and a danger that the wrong information can be used. This is discussed further in Section 4.1.3 of this report and has been raised under GDA issues **GI-AP1000-CC-02** (Ref. 61).

4.7.1.2 Material Substitution

285 The practicality of specifying materials to comply with US standards throughout should be seriously considered since it is inevitable that suppliers will wish to substitute them with locally sourced materials. TQ-AP1000-946 was raised to clarify Westinghouse's stated policy to design globally and source locally, and the procedures to be used to manage the substitution of materials. Factors that required consideration include:

- maximum and minimum specified yield strengths;
- ductility (of both structural steel and of reinforcing steel);
- the means of testing and of specification;
- the effects of exceeding design material strengths.

286 The Westinghouse response to TQ-AP1000-946 states that *"it is recognized that during construction it may be practical to use metric sized permanent features such as rebar or structural plates. These substitutions are made by request using procedure APP-GW-GAP-420, Engineering and Design Coordination Report. This procedure allows requests to be made from the vendor or the constructor and provides the requirements for documenting and approving those requests."*

4.7.1.3 Steel Plate

287 The Step 4 GDA assessment has highlighted the following issues with the steel specifications with specific reference to the CA Modules. However, the same issues on materials could occur in other civil engineering structures and so a general issue is raised under Action A1 of **GI-AP1000-CE-03** (Ref. 65).

288 ASTM A572 Standard Specification for High-strength low-alloy columbian-vanadium structural steel (Ref. 118) only covers Grade 60 up to 1.25 inches thick. Therefore, the 1.5 inch thick plates to be used on the CA Modules (Ref. 86) are not covered by the claimed standard A572.

289 ASTM A572 specifies minimum values of yield and tensile strengths. It does not specify maximum values of these strengths or the ratio of yield to tensile strength, i.e. ductility. Maximum values are specified for European materials to ensure that an element is not significantly stronger than assumed in the design, such that the failure mechanism of the whole system occurs in a different location to that intended by the designer. Similarly, if the ductility of a material is low, this will tend towards brittle failure. Good practice, particularly for seismic structures, is to have ductile failure mechanisms.

290 ASTM A588 Specification for high-strength low-alloy structural steel, up to 50ksi [345MPa] minimum yield point, with atmospheric corrosion resistance (Ref. 120) is for steel with atmospheric corrosion resistance and is usually used on external structures particularly bridges. Weathering steels, such as these, are similar to ordinary structural

steels but with additions of small amounts of alloying elements, typically copper. Under the appropriate environmental conditions, these alloy additions allow the steel to form a stable patina on the surface that greatly slows down corrosion rates compared to other steels and it can therefore be possible to use weathering steels in fully exposed conditions without additional corrosion protection. The UK Highways Agency guidance BD7/01 on the use of this steelwork for bridges (Ref. 121) gives a list of situations where it is not to be used, which includes “where the steel would be continuously wet or damp”. If the conditions are such that the steel is permanently damp, the patina may not form and the steel may continue to corrode. Justification is required that this steel is being used in the appropriate environments.

291 The specification of Charpy V notch impact tests is a normal requirement for structural steelwork in the UK. BS EN 1993 (Eurocode 3, Ref. 122) Part 1-1 requires that brittle fracture is considered for all structures and refers to Part 1-10 for conditions that satisfy that requirement. Part 1-10 gives rules for the selection of the subgrade of steel, i.e. the Charpy V-notch value. AP1000 specifications should therefore ensure the steel complies with BS EN 1993-1-10, including the UK national Annex, since this is a supplementary requirement for the claimed standard ASTM A572.

4.7.1.4 Concrete

292 Section 3.8.4.6.1 of the EDCD describes the concrete material properties in terms of US standards and procedures. For the UK, the detail design of concrete will adopt local constituent materials and therefore the mix designs for all concrete will need to be re-specified for the UK. However, Westinghouse adopts an approach to continue to assume US specifications regardless for materials which will obviously be sourced locally, as in the case of concrete.

293 The items which could be most affected by a change from US to UK standards are as follows:

- Types of aggregate can affect the coefficient of thermal expansion of the concrete. Limestone is the most commonly used aggregate in the UK.
- The mix used for self compacting concrete is of particular concern for steel-concrete composite construction where the size of aggregate and matrix design can affect the shear stud interaction.
- European specifications for concrete now take due account of concrete aging or deterioration effects such as alkali-silica reaction. The US standards proposed need to include the same improvements.
- UK concrete strength testing is usually based on cube strengths rather than cylinder strengths.
- On-site testing of concrete mixes will be different in the UK to that used in the US, and so exact testing procedures need to be confirmed.

294 Although I recognise final material specifications are site specific, I would still expect some generic appraisal of the local materials that are likely to be used and the possible effects on the design. This is best carried out by the current design team who are most familiar with the design.

295 Westinghouse has maintained that the final mix designs and construction specifications will be finalised at site specific stage. The AP1000 specification for concrete is APP-

CC01-Z0-026, *Domestic AP1000 Project Specification: Safety Related Mixing and Delivering Concrete*, (Ref. 123). This document defines the applicable industry specifications that Westinghouse requires for safety related concrete, which includes American codes such as ACI 301, Specification for Structural Concrete (Ref. 94) and ACI 211 Standard Practice for selecting proportions for concrete (Ref. 124).

296 The above specifications are US specific and so would not address how materials testing will be carried out in the UK. I have therefore raised a GDA Issue Action, **GI-AP1000-CE-03.A2**, for Westinghouse to provide ongoing support and any supplementary evidence to justify that these concrete materials specifications do not compromise the structural design intent.

297 Self consolidating concrete is to be used in the steel-concrete (SC) composite walls for the CA Modules and for the Enhanced Shield Building cylindrical wall. Westinghouse was requested to provide justification that this type of concrete would not be detrimental to the structure via Regulatory Observation RO-AP1000-079.A7. Its response is presented in letter UN REG WEC 000370 (Ref. 125). It states that “*self-consolidating concrete (SCC) is a specially proportioned concrete that is highly flowable and non-segregating. It was developed for use where concrete must be placed in confined areas and must flow around reinforcement without the need for any mechanical vibration.*” Further arguments are given that SCC results in better durability and uniform strength, since the quality of the concrete is less reliant upon operator compaction. Test results are given for the current construction in China, to demonstrate shrinkage in SCC to be similar to that in normal concrete.

298 I accept that a properly designed and trialled SCC mix can achieve the claims made by Westinghouse. The final details will not be available until site specific phase and so I raise **AF-AP1000-CE-12** and **AF-AP1000-CE-13** below. My assessment of the potential effects of SCC on the design methodology for SC structures is presented in Section 4.16.7 of this report.

4.7.1.5 Steel Reinforcing Bar

299 The AP1000 generic reinforced concrete design is based upon using US steel reinforcing bar. This has distinctly different material characteristics to that used in Europe. Therefore, a straight substitution of area/unit length of rebar is not possible, since ductility and detailing issues would be affected.

300 I am concerned that there will be considerable commercial pressure for the UK AP1000 civil contractors to use rebar manufactured in Europe to Eurocode specification. Westinghouse has carried out a review with their civil construction partners, the Shaw Group and Laing O’Rourke, and confirmed that importing US rebar to the UK is not commercially prohibitive.

301 I recognise Westinghouse’s strategy is to use US materials and that if subsequent changes are made to this basis, a formal design change process will be initiated.

4.7.1.6 Geotechnical Specifications

302 I have not assessed any material specifications for geotechnical aspects for the AP1000 generic design. Generic site characteristics are described in Section 2 of the EDCD and geotechnical material specifications will need to provide these characteristics. I consider

the main concerns that need to be dealt with at site specific phase to be proving of formation, excavation and backfilling specifications.

4.7.2 Summary and Findings

4.7.2.1 General

303 The generic AP1000 design is based on retaining US standards. However, I have the following three concerns.

- Procedures will need to be robust for accepting suppliers' material substitutions without endangering the design principles.
- The US standards must be at least equivalent to European standards or normal European industry good practice. Additional specification clauses may therefore need to be added.
- Certain materials will almost certainly be sourced locally, e.g. concrete and other bulk materials. The current strategy to use US specifications throughout does not make any allowance for this.

304 The concerns about the control of material substitution and the quality control on site have been captured by the Assessment Findings below.

305 The concerns on whether the materials specified for some structures are equivalent to the EN specifications, have led to the raising of GDA Issue **GI-AP1000-CE-03**.

4.7.2.2 Material Substitution

306 Westinghouse has procedures in place to carry out an engineering and licensing evaluation of the results of a requested change. Although I have not carried out a detailed review of the procedure I accept that it is possible to properly manage the substitution process. The examples given in TQ-AP1000-946 of where this has been used successfully at the current construction site in China, give confidence that the procedure is stringent. However, the licensee will need to justify that the final procedure adopted is robust. This is captured in Assessment Finding below, which must be addressed by milestone 2 – first concrete.

***AF-AP1000-CE-11:** Suppliers may wish to substitute the specified US standards materials with locally sourced materials. The licensee shall justify that the procedures to be adopted for material substitution are robust, such that the design integrity is not compromised.*

4.7.2.3 Material Equivalence to EN Standards

307 I expect that Westinghouse, as the designers, should produce generic specifications for materials which include any additional clauses needed to ensure materials are equivalent to European standards. My specific concerns are with respect to steel plate, concrete and steel reinforcement.

308 GDA Issue **GI-AP1000-CE-03** Action A1 comprises 4 detailed actions with specific reference to steel plate materials, as detailed in paragraphs 288 to 291 above. Although the observations are specifically for the CA Modules, the Issue is raised for the whole generic site to ensure such oversights are not made elsewhere. Correct material specification is fundamental to the safety of the design, e.g. specifying a maximum

strength for steel ensures ductility, so this needs to be properly documented in the safety case.

309 GDA Issue **GI-AP1000-CE-03** Action A2 comprises a single action for Westinghouse to support a review of its concrete construction specification in order to confirm whether it satisfies my expectations for the generic design.

4.7.2.4 Concrete Mix Design and Testing

310 I had anticipated that the generic design would include a more detailed appraisal of the concrete materials in the UK and the standards for testing. This is captured in Action A2 of **GI-AP1000-CE-03** above. However, I recognise final mix design will have to be carried out under Phase 2. Therefore, I raise the following Assessment Findings which must be addressed by milestone 2 – first concrete or by milestone 1 – long lead item procurement if any such items are affected.

AF-AP1000-CE-12: *The licensee shall justify that all site specific concrete mix designs comply with the generic design requirements, including self consolidating concrete.*

AF-AP1000-CE-13: *The licensee shall justify that the concrete materials testing to be used for construction achieves direct correlation between test results and generic design requirements. The procedures for ensuring suitably qualified and experienced test operatives, particularly if US tests are to be adopted, shall also be justified.*

4.7.2.5 Steel Reinforcement

311 I accept that the generic material specification of reinforcing bar for concrete is to US standards. Any subsequent changes to this will be an issue for the Licensee. I therefore raise the following Assessment Finding which must be addressed by milestone 2 – first concrete.

AF-AP1000-CE-14: *In the event that a supplier wishes to substitute US reinforcement for EN standards, the licensee shall justify that the full impact on the design of reinforced structures is properly assessed and that the safety features of the design are not compromised.*

312 The consequences of a change of reinforcement should not be underestimated. Since the yield strength of 'normal' EN bars is twice that of US bars, a straight substitution is not possible.

4.7.2.6 Geotechnical Specifications

313 The specification of geotechnical materials will be site specific. Some generic design parameters have been specified and the licensee will need to ensure these are complied with, or the design changed accordingly. I therefore raise the following Assessment Finding which must be addressed by milestone 2 – first concrete.

AF-AP1000-CE-15 *The licensee shall justify that the geotechnical materials and specifications to be used for the specific site application achieve the generic design requirements, as detailed in Section 2.5 of the EDCD.*

4.8 Metrication

4.8.1 Introduction

314 It is the UK Regulator's expectation that an AP1000, built in the UK, will be a metric design including all safety case, design and supporting documentation, as well as the constructed plant. The Guidance to Requesting Parties (Ref. 8) requires that documents submitted for GDA use SI units. As a corollary, it is the expectation that the design submitted by the Requesting Party is essentially metric, using metric Structures, Systems and Components.

315 A cross-cutting Regulatory Observation, RO-AP1000-038, was raised on 20 July 2009 to confirm the Regulatory expectation that any AP1000 constructed in the UK will be metric. During the Step 4 process, the mechanical engineering assessment discipline has taken the lead in terms of discussing the principles associated with metrication of the AP1000 and establishing the way forward. Individual assessment disciplines have reviewed the output from this process as applicable to their individual areas and drawn conclusions as appropriate.

316 I have raised concerns with respect to civil structures and these are detailed below.

4.8.2 Assessment

4.8.2.1 Assessment Progress

317 The Mechanical Engineering Step 4 assessment report, ONR-GDA-AR-11-010 (Ref. 45), includes a detailed description of the assessment progress on metrication for AP1000. I present the key stages below for ease of reference.

318 Westinghouse provided a response to RO-AP1000-038 on 1 December 2009 which comprised document APP-GW-G1-011 Revision 0, AP1000 Standard Plant Metrication (Ref. 127). This initial cross-cutting response was not considered to be adequate and, following meetings with Westinghouse, ONR issued further guidance via letter WEC70154R dated 17 March 2010 (Ref. 128). The advice was as follows:

1. For construction of the AP1000 in the UK, the regulatory expectation is that the design and associated equipment should be fully metric, i.e. conceived, designed, and manufactured as metric, or as an alternative 'quasi metric', i.e. initially conceived as imperial but now designated and designed as metric using metric codes/standards and fully dimensioned as metric. All fastenings shall be metric.
2. However, exceptionally, the regulator may accept non-metric products (including fastenings) for one-off fabrications of a specialist nature, but these will need to be justified to the regulator on a case by case basis.
3. Notwithstanding the above, all design and safety case documentation shall be fully metric from conception through intermediate results to final presentation.
4. All information displayed within the constructed facility will need to be fully metric.

319 Westinghouse then issued a revised response to the RO Action on 29 April 2010 (Ref. 129) and, following discussions at the subsequent Mechanical Engineering technical meeting in Pittsburgh, Revision 2 of APP-GW-G1-011 was issued on 17 September 2010 (Ref. 130). Westinghouse has accepted the principles described by the guidance and the assessment attention has now focused on the proposed exceptions list. Revision 2 of APP-GW-G1-011 contained a list of proposed exceptions to metrication (with reference to point 2 of the guidance).

320 ONR responded to this latest RO Action by letter dated 11 October 2010 (Ref. 131) which collated the assessment views from each of the disciplines who are leading in the affected technical areas. This included my comments on civil engineering aspects.

321 Westinghouse issued a revised RO response on 31 December 2010 which included Revision 3 of APP-GW-G1-011 (Ref. 132). This states that *“the AP1000 meets the “quasi-metric” expectation, where the design was originally conceived in US units, but will be delivered fully metric with [certain] exceptions.”*

4.8.2.2 Building Structures Generally

322 I regard a fully metric design as being preferable for new build in the UK. However, I accept that a quasi metric approach can be adopted for permanent civil structures provided that it is controlled properly and there is a robust procedure for verifying substitution of metric equivalents for the original imperial design. There are examples in high integrity industries such as aviation and the space programme of confusion in units causing failures. My particular concern is with detailed design and construction of connections and a GDA Issue has been raised on this as described in Section 4.8.2.3. My other concerns regarding control of metric substitutions are captured as Assessment Findings in the following sections.

323 I would not expect building dimensions or tolerances to change for those included in the scope of the generic design. Drawings and key documentation, such as the PCSR, will be presented in metric with imperial equivalents and this is acceptable provided a consistent nomenclature is used.

324 Westinghouse should fully review the practicalities of using US standards in the UK. My primary concerns with this approach are:

- Previous experience of a similar project has shown that suppliers are likely to request many alternatives and the process of approving and justifying substitutions from US to UK standards was very protracted for all parties. This led to time pressures on the licensee's staff with the potential for errors to be made.
- Construction teams will not have extensive experience of the US system and management and supervision on site will require more intensive quality control. This increases the risk of workmanship errors.

4.8.2.3 Steelwork Connections

325 My main concern is the wide-scale use of imperial bolting for structural steelwork. Section 3.2 of Ref. 132 states that *“All AP1000 threaded fasteners will be installed in SI standard sizes, except for fasteners used on components identified in Table A-1.”* Item 1A of table A-1 confirms structural steelwork and *“associated bolting”* will be to US units. Westinghouse states that there is no impact *“due to the fact that permanent features and structures such as structural steel are not operated, maintained or replaced, they are not a concern for the safe operation of the plant. Therefore, having permanent features and structures as an exception to the metrication position has no impact.”* Furthermore *“there is strict quality control of the products during construction, when the piece-parts are vulnerable to units of measure confusion.”*

326 I do not consider this proposal to be acceptable since it includes wide-scale use of imperial bolting/fastenings. Although strict quality control during construction can be

adopted, this makes it unnecessarily complicated on site and there is an increased risk of last minute substitutions, particularly if metric bolts are used elsewhere. Instances of a similar metric bolt being used instead of the correct imperial bolt are not uncommon. I concur that structural fastenings are not routinely changed during a plant's lifetime. However, site License Condition 28 (LC28) will require "Arrangements for Examination, Inspection, Maintenance and Testing" of nuclear safety related structures. SAP ECE.8 requires designs to allow key load bearing elements, e.g. crane bearings, to be inspected periodically and, if necessary, maintained. Experience on UK operating plants is that any subsequent modifications can be more prone to error due to mixed units.

327 Table A-1 of Ref. 132 and the responses to TQ-AP1000-943 and 946 indicate that all parts of steelwork connections, including bolting, are to be to US standards. It is implied that plates and welds for connections are to be to US standards. However, Westinghouse's intentions are not entirely clear. This is captured in GDA Issue **GI-AP1000-ME-02.A2** (refer to Section 4.8.3).

328 Ref. 132 addresses some of my comments raised on Revision 2 (Ref. 130). However, the exceptions listed in Table A-1 do not clearly define what approach will be used for the design of the detailed connections for steelwork, which will be carried out by local suppliers. The update of this document should clarify Westinghouse's intentions on this and discuss the effects if the other approach is used.

329 The use of US specifications for stiffening plates is acceptable. Quality control at the fabrication yard, including suppliers' design, will require further justification and this is raised as **AF-AP1000-CE-16** in Section 4.8.3. The use of US specifications for welds is acceptable subject to the usual justification of welder qualification at construction stage.

4.8.2.4 Steelwork Generally

330 I note that structural steel sections are proposed, which are likely to be rolled in the UK using US steel material properties. I accept that US sections can be adequately sourced within the UK. I also accept Westinghouse's statement that "*last minute, unapproved substitutions are not permitted*".

4.8.2.5 Reinforcement Steel

331 I note that Westinghouse plans to use US specifications for rebar size and material strength. This makes design justification much simpler since a change to European rebar has most effect on material strength, which could have a major effect on the design intent. Where detailing is to be carried out by site specific suppliers in the UK to US codes such as reinforcement drawings and bar schedules, the suppliers' competence in this regard must be assured, e.g. by including suitable clauses in the tender specifications. I therefore raise Assessment Finding **AF-AP1000-CE-17**.

332 I can see potential for UK AP1000 civil contractors to request to use European rebar for the following reasons:

- Commercial gains on material costs by using locally available rebar.
- Familiarity of workforce with European rebar and dimensions.
- To avoid re-calibrating bar bending machines.
- To avoid changing bar mark labelling systems.
- To allow existing quality control procedures to be used.

333 In the event of this happening, the process of approving and justifying substitutions from US to UK standards is likely to be very protracted for all parties, due to its effect on the design at such a late stage.

4.8.3 Findings

334 There are residual concerns with Westinghouse's overall strategy with respect to metrication of steelwork connections and concrete mix design, leading me to raise GDA Issue Action **GI-AP1000-ME-01.A2** and Assessment Findings **AF-AP1000-CE-16** and **AF-AP1000-CE-17**.

335 The GDA Issue action relates to the exceptions list for civil engineering structures. This is only relevant to structures included within GDA, i.e. Class I and II structures. Class III structures, which will be designed as site specific, are to be fully metric (i.e. conceived, designed, and manufactured as metric).

336 The above concerns are captured in Action A2 of the cross-cutting GDA issue as follows:

GI-AP1000-ME-02.A2: *Provide an updated response to document titled 'AP1000 Standard Plant Metrication, APP-GW-G1-011 Revision 3' to explicitly list the exclusions from metrication for Civil Steelwork SSCs. This should include Westinghouse's intention for all the component parts of structural steelwork connections, e.g. bolts, plates, welds, etc and justify why these are considered as exceptions.*

337 Assessment Findings have been raised for items that can be resolved at site specific stage which must be addressed by milestone 2 – first concrete.

AF-AP1000-CE-16 *The licensee shall ensure that the design and fabrication of all steelwork connections is carried out in accordance with the national design standards specified in the GDA design. The licensee shall also justify that the supplier's designers and operatives are suitably qualified and experienced in the use of the chosen national design standards, including weld procedures and consumables. Where the licensee proposes to change the measurement system for design and fabrication, this must be done through a formal design change process.*

AF-AP1000-CE-17 *The AP1000 generic design is based on all reinforcement detailing being carried out in accordance with the US standards specified in the GDA design. The licensee shall justify that the UK local suppliers used for RC detailing has the appropriate competence in this regard.*

4.9 FE Analyses

4.9.1 Introduction

338 The design of the civil structures forming the nuclear island relies on the computer finite element (FE) analyses carried out by Westinghouse. These analyses are used to calculate the forces and displacements that the structures will be subject to under each of the design loadcases. The amount of steel reinforcement required by the concrete structures is then calculated using these forces.

339 It is therefore crucial that the FE analyses model the building correctly in terms of its material make up and its response to loads and loadcases, particularly when undertaking more complex dynamic analysis to determine its response to seismic loading.

4.9.2 Documentation

340 The assessment carried out a review of the following Westinghouse documents:

- European DCD (Ref. 67), Chapters 3.7 and 3.8, Appendix 3G.
- Design Report for the AP1000 Enhanced Shield Building, Westinghouse Document No. APP-1200-S3R-003, Revision 3. 2010. Sections 2.6 and 10 (Ref. 72).

4.9.3 FE Analyses and Codes Used

341 [Redacted]

- [Redacted]
- [Redacted]
- [Redacted]

342 [Redacted]

343 [Redacted]

344 [Redacted]

Analysis Level	Input Conditions	Standard FE Model	Confirmatory FE Model
[REDACTED]	1) [REDACTED]	[REDACTED]	[REDACTED]
[REDACTED]	2) [REDACTED] 3) [REDACTED] 4) [REDACTED]	[REDACTED]	[REDACTED]
[REDACTED]	5) [REDACTED] 6) [REDACTED]	[REDACTED]	[REDACTED]
[REDACTED]	[REDACTED]	[REDACTED]	[REDACTED]
[REDACTED]	[REDACTED]	[REDACTED]	[REDACTED]
[REDACTED]	[REDACTED]	[REDACTED]	[REDACTED]

345

[REDACTED]

346

[REDACTED]

347

[REDACTED]

348

[REDACTED]

349

[REDACTED]



4.9.4 Assessment

- 350 The computer FE analysis programmes used are all industry standard and well known. Therefore, I have not sought further validation of the suitability of the programmes used. The output forces from the structural analysis for concrete structures are post processed, using a spreadsheet to calculate the reinforcement required. This spreadsheet has been sampled during my assessment and found to be satisfactory.
- 351 I consider that the use of $0.8E_c$ for the Shield Building wall in the linear elastic NI-05 model has been adequately justified by Westinghouse. The confirmatory, non-linear analyses include modelling of concrete cracking and comparison of these results, with the standard linear models, show that the reduction in the concrete modulus is conservative.
- 352 The assessment of the soil structure interaction, used in the Level 1 analyses to generate the enveloped input spectrum for the Level 2 analyses, depends on Westinghouse's seismic methodology. This is discussed separately in Section 4.10.
- 353 The response-spectrum input to the Level 2 models is an envelope of those from the time-history analyses (Level 1) but only incorporates translations. This means that rotations of the base (rocking motions) are not included in the response-spectrum analysis of these models.
- 354 TQ-AP1000-1134 was raised asking for a justification of the omission of the rocking motions, including a comparison of the motions, at the top of the Shield Building from the time-history analyses (Level 1) and the response-spectrum analysis (Level 2). Westinghouse's response states that "*the SSI analyses include directly the effect of rocking... The response spectra obtained from the SASSI analyses...are obtained at the bottom of the basemat at nine locations.*" However, since these nine locations are enveloped, any differential displacements between them are removed and since the Level 2 models are fixed base it is not apparent how rocking is modelled.
- 355 The TQ response also includes comparison of forces from Level 1 and Level 2 analyses from document UKP-GW-GLR-018 (Ref. 73). These were only for direct forces and in-plane shears and those from the Level 2 results were higher. At the technical meeting on 1 December 2010, it was agreed that Westinghouse would add a comparison of out-of-plane bending and shear for the elements and also of the overall overturning moments and based shears. In its response (letter UN REG WEC 0000469 Ref. 134) Westinghouse states that "*the comparison of the NI10 and NI20 responses is the appropriate comparison to make*". This response is not accepted since it does not justify that the Level 2 models used for calculating design forces, includes rocking and hence force amplification at the top of the building.
- 356 No justification has been received that the forces at the base of the roof quarter model have been compared against those from the Level 1 models. In order to verify the roof quarter model, I would expect these forces to be similar. Assessment Finding **AF-AP1000-CE-18** is raised to capture my concerns on consideration of rocking in the design.

- 357 Westinghouse's civil/structural design criteria document (Ref. 81) states that the seismic analysis complies with ASCE 4-98 Seismic Analysis of Safety-Related Nuclear Structure (Ref. 92). This standard includes a method for accounting for torsional moments due to accidental eccentricity for the whole building. This requires a horizontal force to be applied equal to the storey shear at a moment arm equal to 5% of the building plan dimension. In Section 3.2.1 of the ESB Design Report (Ref. 72), Westinghouse states that a factor of 1.05 is applied to the horizontal components of seismic force to account for the accidental torsion. This is not equivalent to applying an eccentric load to induce accidental torsion as described in ASCE 4-98.
- 358 TQ-AP1000-994 was raised asking Westinghouse to justify its approach. The response was that Westinghouse considered its calculation to be in accordance with ASCE 4-98. This was discussed at the technical meeting on 30 November 2010 and Westinghouse provided a further response in its letter UN REG WEC 000457 (Ref. 135). This however reiterated the response to TQ-AP1000-994.
- 359 Increasing the horizontal force by 5% is clearly not equivalent to applying that force at an eccentricity of 5% of the building width. However, the ASCE 4-98 method was intended to ensure building robustness for all buildings, including buildings such as offices and commercial. The torsional resistance of buildings, such as nuclear power plants, is not normally a concern and so I consider that this apparent inconsistency can be justified at site specific stage. This is captured in **AF-AP1000-CE-19** below.

4.9.5 Findings

- 360 The licensee shall ensure that the site specific FE analyses, particularly for softer sites, adequately model the potential for rocking of the nuclear island such that any amplification of forces at the top of the Shield Building is captured. The appraisal of accidental torsion should also be revisited at that time. Two Assessment Findings are raised which must be addressed by milestone 2 – first concrete.

AF-AP1000-CE-18: *The licensee shall justify that the site specific FE analyses adequately model the potential rocking of the nuclear island. The Level 2 analyses used to calculate the force and displacement demand shall be compared with the Level 1 analyses to demonstrate rocking has been included. Specific comparison shall be made of forces and displacements at the top of the building.*

AF-AP1000-CE-19: *The licensee shall justify that the site specific FE analyses include an assessment of accidental torsion on the nuclear island model in accordance with the requirements of ASCE 4.*

4.10 Seismic Design Methodology

4.10.1 Assessment Objectives

- 361 The objective of the assessment of the AP1000 seismic analysis was to establish a high level confidence with respect to whether or not the overall seismic analysis and design methodology, adopted by Westinghouse, is broadly suitable for nuclear safety-related civil engineering and structural works in the UK.
- 362 The assessment takes account of the fact that during GDA Phase 2, site specific seismic spectra will be determined. The design loads for the structures included in the generic design must therefore be ultimately checked against the site specific seismic loads. Where there are differences, the licensee must justify that the capacity of the structures

still provide sufficient margins, or must perform enough confirmatory analyses to prove that the generic design is still bounding.

363 This assessment has concentrated on the methodologies used to ensure these are correct, such that when the site specific work is carried out it will be to methods already agreed.

364 The SAPs applicable are ECS.1 and ECS.2 and paragraphs 148 through to 156 (Ref. 4).

365 The results of the assessment described in this section are based on the work carried out by ONR Technical Support Contractors, ABSC (Ref. 25) and Arup (Ref. 34).

4.10.2 Documentation

366 The assessment carried out a review of the following Westinghouse documents:

- European DCD (Ref. 67), Chapters 3.2 and 3.7.
- AP1000 Civil/Structural Design Criteria, Westinghouse Document No. APP-GW-C1-001 Revision 1. 2005 (Ref. 81).
- AP1000 Seismic Design Criteria, Westinghouse Document No. APP-GW-G1-003 Revision 3. 2009. (Ref. 82).
- Extension of Nuclear Island Seismic Analysis to Soil Sites, APP-GW-S2R-010 Revision 4. 2010. (Ref. 136).
- Nuclear Island Seismic Floor Response Spectra, APP-1000-S2C-056 Revision 2. 2010. (Ref. 137).

367 A technical meeting was held with Westinghouse in Pittsburgh on 2 December 2010, in order to clarify queries raised during my assessment.

4.10.3 Seismic Design Criteria

368 The seismic design criteria comprise the seismic performance objective, together with the means employed to achieve the objective.

369 The seismic performance objective includes two aspects:

- The earthquake ground motion excitation to which a structure is designed to resist.
- The structural performance objective – qualitative structural damage state. ASCE Standard 43-05, *Seismic Design Criteria for Structures, Systems and Components in Nuclear Facilities and Commentary*. 2005 (Ref. 138) uses 4 damage states:
 - Essentially Elastic.
 - Limited Permanent Distortion.
 - Moderate Permanent Distortion.
 - Large Permanent Distortion (Short of Collapse).

370 In prescriptive seismic design codes (as opposed to performance-based) the structural performance objective is simplified and approximated by a force-based parameter – the structural response modification factor R in the US and the structural behaviour factor q in Europe.

371 The means for achieving a specified structural performance objective include the following:

- Seismic analysis methods for quantifying seismic force and displacement/deformation demands.
- Design methods and acceptance limits for providing structural strength capacities.
- Proportioning and detailing measures for ensuring ductile behaviour including prevention of undesired failure modes.
- Construction specifications including material specifications, Quality Assurance and Quality Control procedures, workmanship, etc.

372 This assessment reviewed the seismic design criteria adopted by Westinghouse for the AP1000 structures and these are summarised in Table 12 below:

Table 12
AP1000 Seismic Design Criteria

Seismic Category	Design Earthquake Motion	Expected Response and Response Modification Factor	Seismic Analysis Method	Seismic Design Code and Detailing	Construction Specifications
C-I	AP1000 Safe Shutdown Earthquake	Linear elastic no structural damage R = 1.0	ASCE 4-98	ACI 349-01 for RC AISC N690-98 for structural steel	ACI 349-01 for RC AISC N690-98 for structural steel
C-II	as C-I	as C-I	as C-I	as C-I	ACI 318-01 for RC AISC S335 ASD/ AISC LRFD for structural steel
NNS	Zone 2A 1997 UBC Soil S_D Importance Factor = 1	Nonlinear. No major structural failure but loss of function R=7 LRFD or R=10 ASD	1997 UBC	ACI 318-01 for RC AISC S335 for structural steel	ACI 318-01 for RC AISC S335 ASD/ AISC LRFD for structural steel

4.10.3.1 Seismic Class I

373 The seismic design criteria, adopted by Westinghouse for seismic class I structures, are acceptable pending satisfactory resolution on the use of superseded/outdated codes, standards and industry specifications. This is raised as AF-AP1000-CE-04 and 05 (refer to Section 4.3.2.2).

4.10.3.2 Seismic Class II

374 The seismic design criteria for seismic class II structures are the same as those for seismic class I structures in every aspect, except items relating to quality control and quality assurance during the construction phase. Construction of C-II structures would be in accordance with lower standards, rather than nuclear safety-related codes and

standards, which may lead to structural performance not being as high as that achieved by C-I structures. This concern was investigated as described in Section 4.3.1.

- 375 The seismic performance of seismic C-II structures may not be as high as that of seismic C-I structures, due to the adoption of lower QA and QC standards for construction. However, due to the adoption of R=1 and the use of nuclear safety related codes and standards for structural analysis, design and acceptance criteria, and the fact that the lower QA and QC provisions are still sufficient for prevention of structural collapse and structural failure, the performance of seismic C-II structures are sufficient to achieve the goal stated in Section 3.2.1.1.2 of the AP1000 European EDCD (Ref. 67).

4.10.3.3 Seismic Class NNS

- 376 The 1997 Uniform Building Code (UBC, Ref. 90) ceased to be a building code in the US on 1 January 2008. Therefore, the use of the 1997 UBC for Class 3 structures outside the US in the UK also becomes unacceptable. Westinghouse stated in the meeting of 2 December 2010 that they intend to use the International Building Code (IBC, Ref 101) for the design of the UK specific Turbine Building. However, this has not been documented and so is captured in **AF-AP1000-CE-20** below.
- 377 In the UK it is mandatory to design for prevention of disproportional collapse. This requirement is explicitly stated in the Approved Document A3 Disproportional Collapse of The Building Regulations 2000 (Ref. 140). However, such a requirement does not exist in the 1997 UBC and indeed, nor in its successor the IBC either. TQ-AP1000-996 was raised to request Westinghouse to demonstrate compliance with the Building Regulations or, alternatively, to confirm that Westinghouse considers this to be a matter for the site licensees. In the response to TQ-AP1000-996, Westinghouse confirmed that they do not intend to address specific local building requirements during the GDA but this would be covered under site specific design. This is captured in **AF-AP1000-CE-21** below.
- 378 In summary, AP1000 seismic class NNS structures are broadly consistent with Class 3 structures of the SAPs (Ref. 4). Indeed, UK Class 3 structures would not normally need to be designed for seismic loading and so the argument over UBC 1997 of IBC is somewhat academic.

4.10.3.4 Findings

- 379 Two Assessment Findings result, which must be addressed by milestone 2 – first concrete.

AF-AP1000-CE-20 *The licensee shall update the seismic analysis and design methodology documents to confirm which code has been used for the non-nuclear seismic class, UBC1997 or IBC 2009.*

AF-AP1000-CE-21 *The licensee shall substantiate that the site specific design for non-nuclear seismic class buildings, accounts for the prevention of disproportional collapse in accordance with the UK Building Regulations 2000 or version current at that time.*

4.10.4 Seismic Analysis Methodologies

4.10.4.1 Assessment

- 380 This section considers only the analyses carried out for Class I and II structures. The FE models are described in Section 4.9.
- 381 Westinghouse states in its Seismic Design Criteria (Ref. 82) that its analyses are in accordance with ASCE 4-98. The seismic analysis methods adopted for seismic Class I and II primary structures are identical. The seismic ground motion input to both categories of structures are also identical, namely the AP1000 SSE ground motion.
- 382 Westinghouse adopts the dynamic time history analysis method for performing the seismic analysis of subsystems, e.g. a flexible floor or a miscellaneous steel frame. The time history input motions to such subsystems are obtained from a model including the primary system or a larger subsystem. This method is satisfactory and acceptable.
- 383 Westinghouse adopts the time history analysis method for generation of floor response spectra. Such spectra are enveloped over the generic soil profiles and are broadened by $\pm 15\%$ in the frequencies associated with the peaks in the curve. This method and procedure are satisfactory and acceptable.

4.10.4.2 Soil Structure Interaction Analyses (SSI)

- 384 Section 3.3.1 of ASCE 4-98 describes two acceptable SSI methods – the direct method and the impedance method.
- 385 The direct method models the soil and the structure in a single model and uses finite elements for both. The analysis can be carried out in one step. The advantages of this method are many since it can model complex geometry of both soil and structure, including non-linear soil behaviour, and so does not inherently simplify the soil-structure interaction.
- 386 The impedance method is also termed the sub-structure method since it breaks the analysis into 3 steps. These are 1 - solving the free-field soil response, 2 – solving for the soil impedance functions and 3 - solving the dynamic response of the structure. The impedance function method is limited in that it uses springs and dampers to represent the soil impedance and thus is based on linear elastic soil behaviour.
- 387 The direct method is considered current good practice since it is a generally applicable method without limitations. It eliminates the need for linearization and simplification. Modern, fast computing power and increased memory, has made the direct method using finite elements the preferred method for seismic SSI analysis for sites in which the nonlinear behaviour of soil is significant.
- 388 The AP1000 Seismic Design Criteria document, Section 6.5 (Ref. 82) does not specify which one of the two acceptable methods is adopted by Westinghouse. However, the top level document AP1000 Civil/Structural Design Criteria, Section 2.1 (Ref. 81) does state that *“Two types of soil-structure interaction analyses are required. An overall seismic analysis of the building for the superstructure design and a local analysis of the foundation for its design. In the superstructure analysis the soil is represented by finite elements for the nuclear island and springs for all other buildings. For the local foundation design, the foundation shall be modelled as a plate on elastic foundation with the soil represented by springs; this is applicable to all buildings.”* The statement that the soil is represented by finite elements appears to indicate the Direct Method would be used for all C-I buildings and the Impedance Method for C-II buildings. This disagrees

with the Seismic Design Criteria document (Ref. 82) which states the design methodologies of C-I and C-II are identical.

4.10.4.3 Findings

389 The seismic analysis methods are generally in accordance with ASCE Standard 4-98 and are therefore satisfactory and acceptable. However, there is uncertainty as to the exact procedures followed. Therefore, the following Assessment Finding has been raised which must be addressed by milestone 2 – first concrete.

AF-AP1000-CE-22: *The licensee shall revise the Civil/Structural Design Criteria document to state which ASCE 4-98 method they have used, i.e. the impedance method or the direct method. The licensee shall correctly describe in the same document how the soil is modelled by the method adopted.*

4.10.5 AP1000 Generic Ground Motion

4.10.5.1 Definition of Hard Rock

390 The Westinghouse definition of a hard rock site is that the shear wave velocity should be a minimum of 2438 m/s (8000 feet/sec, Section 3.7.1.4 of EDCD). This is extremely hard, even compared with US standards IBC 2009 (Ref. 101) and ASCE 7-10 (Ref 102), which define hard rock sites as having a minimum shear wave velocity of 5000 feet/sec. Few candidate sites in the UK, if any, can meet the above Westinghouse definition to be classified as hard rock sites.

391 Westinghouse documents APP-GW-C1-001 AP1000 Civil/Structural Design Criteria (Ref. 81) and APP-GW-S2R-010 Extension of Nuclear Island Seismic Analyses to Soil Sites (Ref. 136) use the terms “base rock” and “bed rock” interchangeably. Furthermore, Ref. 81 states in paragraph 2.1 that “a computer analysis of soil-structure interaction must be performed for the Seismic Category I buildings for static and dynamic loads for those foundations not supported on bedrock.”

392 TQ-AP1000-1142 was raised to confirm Westinghouse’s definition of bedrock. The response was that in the SSI analysis, bedrock is the same as hard rock, i.e. a shear wave velocity greater than of 8000 feet/sec.

4.10.5.2 Generic Spectra

393 Westinghouse’s premise for its generic design is that the enveloped spectra resulting from the Level 1 analyses used will bound the site specific spectra. TQ-AP1000-952 was raised to request evidence showing this was the case for available UK standard spectra. Westinghouse’s response provided the comparison shown below in Figure 5. This shows the AP1000 hard rock horizontal response spectrum against the standard UK spectra for hard, medium and soft sites. These are termed PML spectra since they were developed by Principia Mechanica Ltd in the 1980s and have historically been accepted for application at UK sites.

394 The AP1000 generic spectrum (dark blue) generally envelopes the PML hard site spectrum (green) except in a short frequency range around 10 Hz in which the former is somewhat lower. Both are for 5% damping. For UK hard sites, the AP1000 generic spectrum may be considered acceptable. However, the UK medium and soft sites (red and light blue) exceed the AP1000 generic spectrum between approximately 5Hz and

15Hz, which is a common response range for buildings. Therefore, the AP1000 generic spectrum cannot be considered bounding.

Comparison of PML and AP1000 Earthquake Spectra

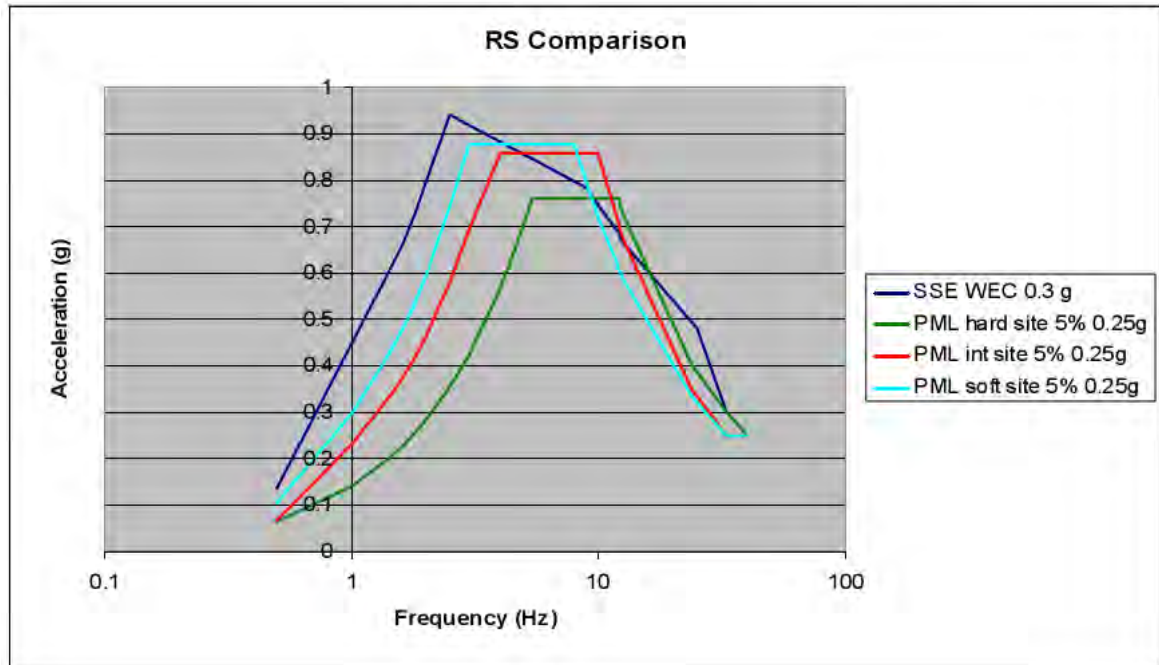

Figure 5: Comparison between AP1000 Spectrum and the UK PML Spectra (From Westinghouse response to TQ-952)

4.10.5.3 Input Motion to SSI Analyses

395 The basis of Westinghouse's AP1000 generic seismic analysis is for a site where there is extremely hard rock outcropping at the surface (8000feet/sec). In the Extension of NI Seismic analysis to Soil Sites (Ref. 136) Westinghouse has attempted to extend its hard rock analysis to soft sites. The range of sites considered is given in Section 3.7.1.4 of EDCD. However, it became apparent during my assessment that the same input motion was used for all 6 sites and was applied at the ground surface (free field). TQ-AP1000-1141 was raised to seek clarification on how Westinghouse had applied the input motions.

396 The response to TQ-AP1000-1141 confirmed that Westinghouse applied the same generic SSE hard rock outcropping motion at the ground surface in the free-field to the hard rock site analysis and the five soil sites. Westinghouse also confirmed that "*Based on actual site soil conditions, Westinghouse will work with future license applicants to provide additional soft soil seismic justification as required based on actual site soil and seismic conditions*".

397 Applying a hard rock input motion at ground level to a soft site SSI model is incorrect. Either the hard rock input motion should be applied as the rock incoming motion or the soil site free surface motion should be applied at ground level. Figure 6 below illustrates this.

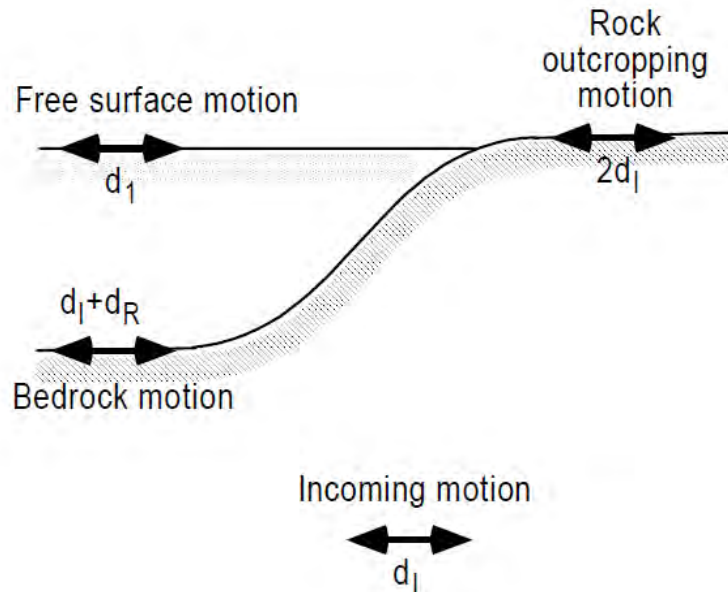

Figure 6: Seismic Ground Motions

- 398 The incoming motion for a hard or soft site should be the same for the same definition of bedrock. This motion is then modified by the soil deposits as it travels to the ground surface (left hand side of Figure 6). Therefore the motion at ground level (free field) will be different for different soil sites. It is well-known that soft soil deposits amplify the incoming rock motion by the time it reaches the surface (Ref. 34).
- 399 The five generic soil sites used by Westinghouse all consider that bedrock (with shear wave velocity of 8000feet/sec) will occur at 37m (120ft) below ground level. For UK sites it is unlikely that this type of bedrock will be close to the ground surface and may be too deep to be confirmed by geotechnical boreholes. The need to reach hard rock (bedrock or base rock) may create practicality problems in both analysis and site geotechnical investigation. In the former, the analysis model becomes large. In the latter, boreholes may have to go down very deep but still have not yet reached the defined hard rock (bedrock or base rock) material.
- 400 In the UK it is usual practice to define the free-field surface motion for soil sites. The analysis model can stop at a shallower depth and the site geotechnical investigation can be terminated at much shallower depth, without the need to reach the hard rock material. The SSI computer program can then calculate the base input motion at the depth at which the analysis model terminates.

4.10.5.4 Findings

- 401 The AP1000 seismic analysis for the generic hard rock site is accepted. The extension to soil sites is not accepted because:
- The strata of the soil sites considered are not applicable to UK sites.
 - The hard rock outcrop input motion was applied at the ground surface for the SASSI SSI analyses for the five soil sites. This is not correct and could be unconservative.

402 This is an important gap in Westinghouse's safety justification. However, it can be resolved by re-analysing the AP1000 SSI models with the site specific spectra applied at the correct position. The output spectra would then need to be compared against those used for the generic structural analyses and, if there are significant differences, design verifications must be carried out again using the new seismic demands from the re-analysis work. This is raised as the following Assessment Findings which must be addressed by milestone 2 – first concrete.

AF-AP1000-CE-23: *The licensee shall carry out the soil structure interaction analyses (Level 1) for the specific site application and shall apply the input spectra at the location that is appropriate for the type of spectra, i.e. for free field site specific soil spectra it is appropriate to apply at the ground level.*

AF-AP1000-CE-24: *The licensee shall demonstrate that the nuclear island response spectra, resulting from the SSI analyses, are bounded by the generic spectra or carry out re-analysis work to ascertain the new seismic demands and check the structural design against these.*

4.10.6 Floor Response Spectra

4.10.6.1 Assessment

403 Primary elements of the civil structures are modelled explicitly in the various structural finite element models. Therefore, model output results can be used directly for the structural design. Equipment and components are not usually modelled explicitly and so seismic loads on these must be established separately. Standard practice is to use a suitable FE model of the equipment/component and apply the floor response spectra for its location. Floor response spectra are generated from the main civil structural analysis.

404 The Westinghouse document APP-1000-S2C-056 Nuclear Island Seismic Floor Response Spectra (Ref. 137) describes the development of floor response spectra for design and qualification of equipment and components.

405 Westinghouse has used the dynamic time history method for computing the seismic response of the primary structures of the AP1000 Nuclear Island. Acceleration response time histories of selected nodes of the Nuclear Island finite element model are obtained as results. These nodal acceleration time histories are then used to compute the floor response spectra. This adopted Nuclear Island floor response spectra calculation methodology is satisfactory.

406 In the Westinghouse document Extension of Nuclear Island Seismic Analyses to Soil Sites (Ref. 136) a comparison of the responses of the NI-10 and NI-20 models was made in Appendix C. The NI-10 model is used for hard rock sites only and is thus fixed base. The NI-20 model was used in SASSI with the five soil sites. To compare directly, the NI-20 model was re-run but on a fixed base using ANSYS and the results compared against those for the SASSI SSI analysis at a hard rock site. This comparison showed that the two sets of results are very similar. This conclusion is as expected and only substantiates that the generic floor response spectra are applicable for hard rock sites.

407 Due to the concerns raised in Section 4.10.5 that the soil structure interaction has not been modelled correctly for soil sites, an Assessment Finding is raised as follows which must be addressed by milestone 2 – first concrete.

AF-AP1000-CE-25: *Following the site specific soil structure interaction analysis, the licensee shall justify that the resulting floor response spectra are bounded by the generic spectra. If they are not, then the equipment/component qualification must be revisited and justified.*

4.10.7 Accuracy of Seismic FE Model

4.10.7.1 Mesh Size

- 408 The global FE model of the nuclear island is an approximation of the real structure. The size of elements and resulting mesh density is therefore chosen by the designers. The size of elements chosen by Westinghouse is quite large by comparison with current good practice (20ft, 10ft and 5ft). This is because these models were originally built some years ago when computing power was less extensive. Therefore, competent designers must satisfy themselves that the mesh size is fine enough to achieve results of an acceptable accuracy.
- 409 In finite element analysis, common practice is to halve the mesh size and compare the results of the original coarse model with the refined model. This process is then repeated until the results are comparable.
- 410 The comparison carried out between floor response spectra of the NI-20 and NI-10 models (see paragraph 406) found that the two models give similar results at low to intermediate frequencies only. At intermediate to high frequencies, the coarse NI-20 model results in significantly higher floor response spectral values than those obtained from the fine NI-10 model. As a result, Westinghouse concluded that further refinement of the model would reduce response spectra still further. Therefore, the results from the finer NI-10 model are conservative and this is used to perform all seismic analysis of the AP1000 Nuclear Island at hard rock sites.

4.10.7.2 Soil Impedance

- 411 Considering the results of the above verification, it is reasonable to expect the NI-10 model would be used for the SASSI SSI analyses for soil sites. However, the NI-20 model was used for this and Westinghouse has indicated that this is because the SASSI 2000 and ACS SASSI computer programmes cannot handle a more refined model such as NI-10. Given the available modern computing power at low cost and modern software technology, I do not consider the use of SASSI 2000 as current good practice.
- 412 SASSI relies on calculating the soil impedance functions at node positions on the base slab/soil boundary. Therefore, these calculations can only be done on coincident nodes. Figure 7 below is a reproduction of Figure 4.4.2-3 from Extension of Nuclear Island Seismic Analyses to Soil Sites (Ref. 136) which illustrates the mesh density for the NI-20 model boundary with the soil.

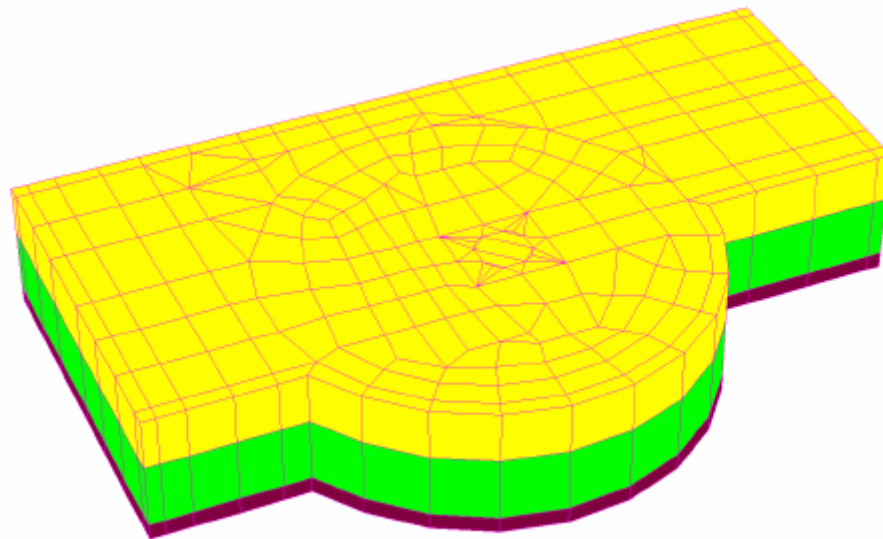

Figure 7: The FE Mesh of the Excavated Soil in the NI-20 SASSI Model

413 Following the technical meeting of 2 December 2010, TQ-AP1000-1192 was raised to request evidence from Westinghouse to demonstrate that the finite element mesh density of the NI-20 model is sufficiently fine for achieving converged results. Westinghouse's response stated that the mesh refinement study, already mentioned above, comparing NI-20 and NI-10 showed that NI-20 was conservative. This does not address the issue since the comparison was for fixed based analyses of NI-20 and NI-10, and so does not include the soil impedance function. This is captured in **AF-AP1000-CE-26** below.

4.10.7.3 Time Step Verification

414 Similarly to mesh size, the time step duration is chosen by the designer. To check this is sufficient it is normal practice to refine it sequentially until the results diverge. In the meeting on 2 December 2010, Westinghouse confirmed this process had been done and the final time step used in the ANSYS time-domain time history analysis was 0.005 seconds. This time step size can integrate dynamic response up to approximately 40 Hz.

415 The time step size adopted by Westinghouse is sufficiently short to capture responses in the frequency range of interest. Further time step size refinement is not considered necessary (Ref. 34).

4.10.7.4 Frequency Time Step Verification

416 The solution of the dynamic response is performed at discrete frequency points in the frequency domain in SASSI due to the frequency-dependent nature of the soil impedance functions. The frequency points are selected by the designer and intermediate points are calculated by SASSI by interpolation. Therefore, competent designers must satisfy themselves that the numbers of frequency points are sufficient. The SASSI 2000 User's Manual provides a facility to the designer to perform a sensitivity analysis and thus establish confidence on the dynamic response results.

417 TQ-AP1000-1193 was raised to clarify if and how the frequency solution points refinement verification in the SASSI SSI time history analysis had been performed. In its

response, Westinghouse confirmed that a solution point refinement study was performed by manually checking the interpolation function for the NI-20 model to ensure that a sufficient number of frequency points had been used. This is in accordance with Section 4.2.2 of the SASSI 2000 User's Manual and is therefore satisfactory.

4.10.7.5 Findings

418 The use of the NI-10 ANSYS fixed base model to generate input spectrum for the Level 2 analyses is acceptable for hard rock sites.

419 The use of the coarse NI-20 model within the SASSI SSI models for soil sites has not been verified by mesh refinement studies, which specifically consider the soil impedance functions. This has been captured in the following Assessment Finding which must be addressed by milestone 2 – first concrete:

AF-AP1000-CE-26: The licensee must justify using the NI-20 model in its site specific SSI model by performing a mesh sensitivity verification, which includes soil impedance functions.

420 The time step and frequency time steps used in the NI-20 SASSI analyses have been verified by the recognised refinement verification process.

4.10.8 Seismic Interaction of NI with Other Buildings

4.10.8.1 Acceptance Criteria

421 The Westinghouse seismic methodology (Section 3.7.2.8 of EDCD, Ref. 68) is that C-II and NNS structures must be evaluated to confirm that their seismic response to the SSE does not interact adversely with C-I structures. C-II structures are designed for the same seismic event, the SSE, and must not impact or collapse onto C-I structures.

422 During a seismic event, there is a possibility that adjacent buildings may collide with each other. To avoid this, isolation gaps are normally provided both between the superstructures and between the foundations. Section 12 of the Civil/Structural Design Criteria (Ref. 81) states the following criteria:

423 *“The minimum gaps between buildings superstructures shall be the greater of either two times the absolute sum of the maximum displacement of each building under the most unfavourable load combination or four inches, whichever is more.*

424 *“Adjoining buildings shall be structurally separated from the nuclear island structures by a two inch gap at and below the grade.”*

425 Interaction between buildings must also consider the suitability of movement joints in terms of their effectiveness, practicality and longevity. The effect on plant items, which pass between buildings, must also be considered.

4.10.8.2 Interaction Analyses

426 The document AP1000 2D SSI Analysis with Adjacent Buildings, APP-1000-S2C-025 (Ref. 141) considers the interaction between the nuclear island and the adjacent buildings during the SSE seismic event. The generic building layout is shown below in Figure 8. The heights of the buildings are all different as shown.

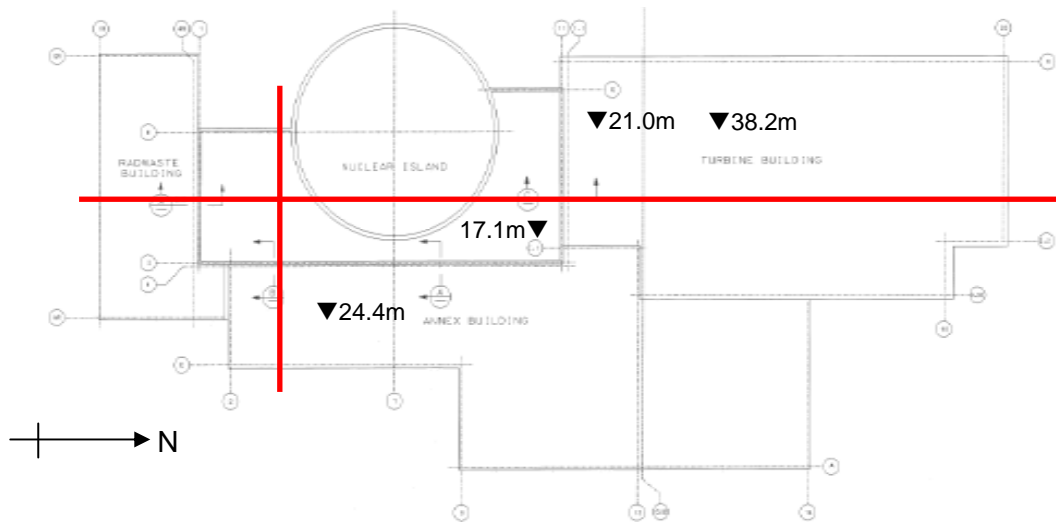
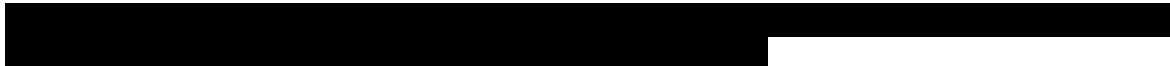

Figure 8: Nuclear Island and Adjacent Structures (Figure A-1 of Ref. 141)

427 APP-1000-S2C-025 is a study of the nuclear island and the surrounding structures for a variety of soil and hard rock sites. 2D models are built for N-S and E-W sections through the adjacent buildings, shown in Figure 8 above. The Auxiliary Building and the Shield Building, both on the NI foundation raft, act as one structure.

428 The soil models are built using SASSI, based on the NI-20 FE model. The hard rock model is a fixed base model built in ANSYS and based on the NI-10 FE model.

429



Site Strata Type	North South Model		East West Model	
	Radwaste Building Foundation to Nuclear Island	Turbine Building Foundation to Nuclear Island	Annex Building Foundation to Nuclear Island	Top of Annex Building to Nuclear Island (EL.180)
[REDACTED]	[REDACTED]	[REDACTED]	[REDACTED]	[REDACTED]
[REDACTED]	[REDACTED]	[REDACTED]	[REDACTED]	[REDACTED]
[REDACTED]	[REDACTED]	[REDACTED]	[REDACTED]	[REDACTED]
[REDACTED]	[REDACTED]	[REDACTED]	[REDACTED]	[REDACTED]
[REDACTED]	[REDACTED]	[REDACTED]	[REDACTED]	[REDACTED]
[REDACTED]	[REDACTED]	[REDACTED]	[REDACTED]	[REDACTED]
[REDACTED]	[REDACTED]	[REDACTED]	[REDACTED]	[REDACTED]
[REDACTED]	[REDACTED]	[REDACTED]	[REDACTED]	[REDACTED]
[REDACTED]	[REDACTED]	[REDACTED]	[REDACTED]	[REDACTED]
[REDACTED]	[REDACTED]	[REDACTED]	[REDACTED]	[REDACTED]
[REDACTED]	[REDACTED]	[REDACTED]	[REDACTED]	[REDACTED]
[REDACTED]	[REDACTED]	[REDACTED]	[REDACTED]	[REDACTED]
[REDACTED]	[REDACTED]	[REDACTED]	[REDACTED]	[REDACTED]
[REDACTED]	[REDACTED]	[REDACTED]	[REDACTED]	[REDACTED]

Table 13: Relative Displacements of Adjacent Buildings (Table A-1 of Ref. 141)

- 430 The maximum relative displacement of 36.4mm (1.434") occurs in the E-W direction for the soft soil site at the top of the Annex Building. The displacements in the N-S direction for the top of the Turbine Building first bay and Radwaste Building are not given. However, Westinghouse argues that since the NI is narrower in the E-W direction, this will give a higher displacement than the N-S direction. This is supported in part by comparing the E-W and N-S relative displacements for the foundations, although rocking will be small at this elevation.
- 431 The maximum relative displacement between the NI and any other foundations is 11.3mm (0.446") for the hard rock 500 site. Therefore, for the generic sites considered, the 50mm (2") criterion given in Ref. 81 for foundations is satisfied in this case.
- 432 The calculation for the superstructures was not readily apparent. The document *Nuclear Island Seismic Floor Response Spectra* (Ref. 137) gives maximum displacements for certain nodes at a height of 18.3m, predicted from a fixed base nuclear island analysis. Therefore, a deeper sample was carried out by ABS Consulting (ABSC) in support of ONR (Ref. 27) for the isolation gap between the Turbine Building first bay and the NI. The maximum cumulative relative displacement was estimated to be 75mm (3 inches).
- 433 It is stated in Section 5.5 of the Seismic Design Criteria (Ref. 82) that "*The nominal horizontal clearance between the structural elements of the Turbine Building above grade and the Nuclear Island and Annex Building is 12 inches.*" Therefore, I conclude that the 150mm (12 inches) isolation gap, provided between the superstructures of the Auxiliary Building and the Turbine Building first bay, agrees with the design target gap as stated in paragraph 423 above.
- 434 ABSC also carried out a check on the calculation of the isolation gap between the Turbine Building first bay (C-II) and the rest of the building (NNS). The gap required between superstructures is 210mm (8.25 inches). However, the gap provided is 254mm (10 inches) which is not twice that required. Westinghouse letter (Ref. 142) states that this criterion "*is interpreted to apply to displacement between adjacent buildings and not to displacements within the same building such as the First Bay and Main section of the Turbine Building which shares a common basemat.*" This appears to be a variation to the high level criteria set out in the Civil/Structural Design Criteria (Ref. 81).
- 435 Since the Turbine Building is to be redesigned for the UK, the isolation gaps will need to be recalculated and the exact acceptance criteria can be finalised then. This is covered by **AF-AP1000-CE-27** below.

4.10.8.3 Interaction of Radwaste Building with Auxiliary Building

- 436 The 2D analysis in the N-S direction of the Radwaste Building adjacent to the Auxiliary Building has not been sampled in detail. However, Section 3.7.2.8.2 of the EDCD states the outcomes of the analysis. The Radwaste Building will strike the Auxiliary Building under an SSE event. Westinghouse has assessed the impact on the RC wall of the Auxiliary Building and concludes that the maximum kinetic energy generated is all absorbed by the concrete structure. The resultant forces, stresses and strains are all bounded by the tornado missile load case.

4.10.8.4 Interaction of NNS Turbine Building with C-II First Bay

- 437 The provision of an isolation gap alone is far from sufficient to substantiate the claim that any structural failure of the NNS part in the Turbine Building, when subjected to the Safe

Shutdown Earthquake, will not propagate to the C-II part. Such a scenario is a “beyond the design basis event” for the first bay.

438 The seismic design methodology for the Turbine Building is outlined in Section 5.5 of the AP1000 Seismic Design Criteria document (Ref. 82) as summarised in Table 14 below.

Table 14
Seismic Design Methodology for Turbine Building

Section	Seismic Class	Design Earthquake Motion	Expected Response and Response Modification Factor	Seismic Analysis Code	Seismic Design Code
1 st Bay	II	Safe Shutdown Earthquake	Linear elastic no structural damage R = 1.0	ASCE 4-98	ACI 349 for RC AISC N690 for structural steel
Main Area	NNS	1997 UBC Zone 3 Importance Factor = 1	Non-linear with moderate to severe structural damage due to R = 7.0	1997 UBC	ACI 318 for RC AISC S335 for structural steel

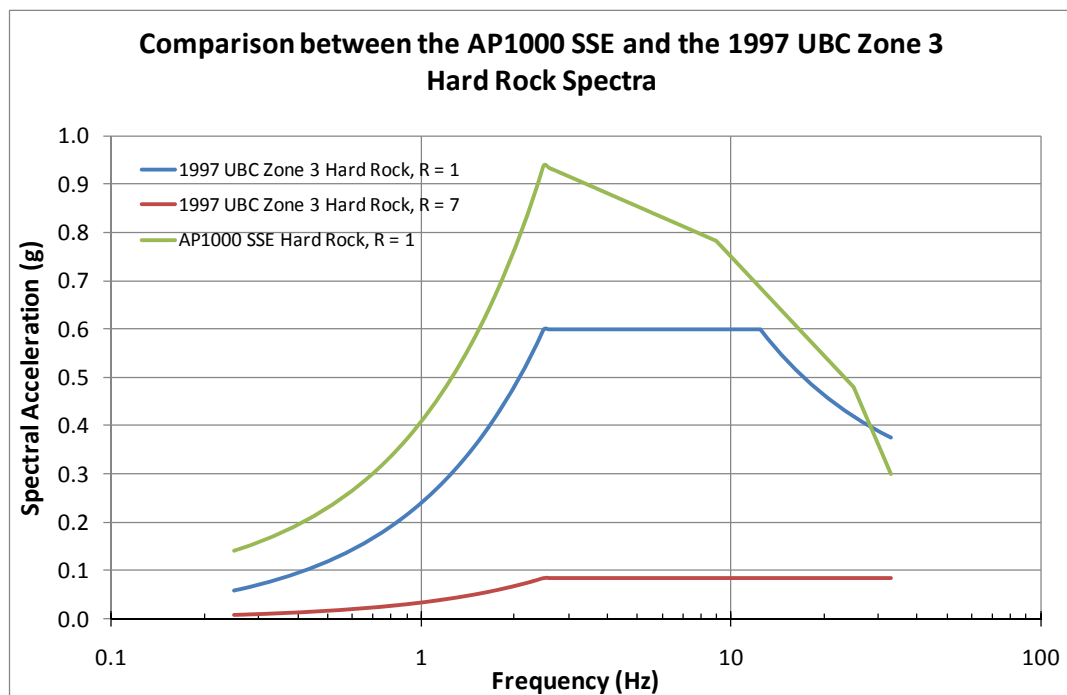

Figure 9: Comparison of Spectra for two parts of Turbine Building

- 439 To illustrate the different earthquake motions, Arup produced a plot (Ref. 34) of the design response spectra for the two sections of the Turbine Building for hard rock sites and for 5% of critical damping. This is repeated as Figure 9 above. The green spectrum is the one used for the first bay. The red spectrum is the one used for the main area. This is compared to the elastic design spectrum of the 1997 UBC (blue spectrum).
- 440 The input spectra for the two areas of the Turbine Building are considerably different. For the first bay, the peak ground acceleration (PGA) of the AP1000 Safe Shutdown Earthquake (hereafter referred to as SSE) at hard rock sites is 0.3g. For the main area the PGA at hard rock sites of Zone 3 of the 1997 UBC is 0.24g.
- 441 The peaks in the building design response spectra are approximately at 2.5 Hz, at which point the design spectrum for the main area (red) is about 1/10 of that for the spectrum of the AP1000 SSE for the 1st bay (green). Therefore, under an SSE event, the main area will be subject to loads significantly over its design basis. Since the main area is a taller structure than the first bay and the Auxiliary Building, it is credible that it could collapse on top of the roof of the Auxiliary Building. To avoid this, the main area will need to be detailed to allow a ductile response such that there may be greater displacement and yielding but collapse would not occur.
- 442 The 2D analyses described above were presented by Westinghouse at a technical meeting in September 2010 in order to demonstrate that the main area did not collapse onto the first bay under SSE loading. Westinghouse concluded that the size of the two isolation gaps between main bay/first bay and first bay/aux building were based on the results on these analyses as discussed above.

4.10.8.5 Findings

- 443 The methodology of using 2D SASSI models to confirm the behaviour of NNS under SSE in terms of building interactions and confirming required isolation gaps is acceptable for hard rock sites. However, when this is applied to UK sites where the soil structure interaction is more dominant, 2D analyses may not be sufficient to model interactions of foundations with one another. This results in the following Assessment Finding which must be addressed by milestone 2 – first concrete:

AF-AP1000-CE-27: The licensee shall justify the soil structure interaction (SSI) analyses for the interaction between buildings for the specific site application. Where 2D analyses are used, the licensee shall justify that these adequately model the interactions between adjacent buildings for the ground strata for that site, particularly where one foundation imposes overburden pressures on an adjacent below ground structure or affects settlement interactions. The isolation gaps between foundations and superstructures, provided in the generic design, must be justified or recalculated. This shall also include interaction between distinct parts of buildings on common foundations, such as the Turbine Building first bay and main structure.

- 444 The effect of the differential movement between buildings on plant and services passing over the movement joints, must be appraised once the site specific SSI is completed. This results in the following Assessment Finding, which must be addressed by milestone 2 – first concrete.

AF-AP1000-CE-28: *The licensee shall provide details of the building movement joints between the Nuclear Island and adjacent structures in terms of their effectiveness, practicability and longevity. This shall also include justification that plants and services passing over the building movement joints can accommodate the relative movement predicted.*

445 The analyses for the NNS Radwaste Building and Turbine Building will need to be repeated to justify that either these buildings will not collapse under SSE or, if they do, it will not affect the continued safe operation of Class I and II SSCs or affect the required access for personnel and vehicles to these SSCs. This must be addressed by milestone 2 – first concrete.

AF-AP1000-CE-29: *The licensee shall justify that the performance of NNS buildings under the C-I seismic event, i.e. SSE will not adversely affect the performance of C-I structures. Consideration shall be given to potential collapse of NNS structures, either directly onto C-I structures or causing collapse of C-II structures onto C-I structures. Consideration shall also be given to collapse of NNS structures preventing appropriate access on the site to the safety systems required for safe shutdown.*

4.11 Nuclear Island Foundation and Basement

4.11.1 Design of Raft Foundation

4.11.1.1 Assessment

446 The raft foundation (or basemat) to the nuclear island is described in Section 3.3.1 of this report. The following information has been obtained from Section 3.8.5 of the EDCD.

447 The nuclear island structures consisting of the containment building, Shield Building, and Auxiliary Building, are founded on a common 1.83m cast-in-place reinforced concrete raft foundation. The top of the foundation is at elevation 89.789 m (66'-6").

448 The design of the raft consists primarily of applying the design loads to the structures, calculating shears and moments in the raft and determining the required reinforcement. The analyses are carried out using a 3D ANSYS finite element model shown in Figure 3.8.5-2 of the EDCD. The sub-grade is modelled with one vertical and two horizontal springs at each node, which account for any uplift of the raft slab. The analyses of the raft, account for the range of soil sites described in EDCD Section 2.5. Horizontal bearing reactions on the side walls below grade are conservatively neglected.

449 Normal and extreme environmental loads and containment pressure loads are considered in the analysis. The normal loads include dead loads and live loads. Extreme environmental loads include the safe shutdown earthquake. Section 3.8.5.3 of the EDCD states that the "*containment pressure loads [from the bottom dome] affect the nuclear island basemat since the concrete is stiffer than the steel head. The containment design pressure is included in the design of the nuclear island basemat as an accident pressure*".

450 Two critical portions of the raft were identified from the analyses results (Section 3.8.5.4.4) and these were designed as two way spanning slabs in accordance with ACI 349-01. Shear reinforcement is provided below the Auxiliary Building in accordance with ACI 349-01 i.e. where the factored shear force is less than $0.5 \times \phi V_c$, with V_c being the shear strength calculated to the code.

4.11.1.2 Summary and Findings

- 451 My assessment of the nuclear island foundation has been based primarily on the evidence provided in the EDCD. I have not sampled any calculations or detailed technical documents.
- 452 The methodology of the structural analysis and design of the basemat is reasonable. Potential uplift of the raft slab is included in the model.
- 453 The loadcases considered are reasonable. The reinforcement design is in accordance with code ACI 349-01, which although an established code, it is not the current version (refer to Section 4.3.2).
- 454 The soil sites considered are the same as those used for the global SSI analyses (refer to Table 11 of this report). I therefore have the same reservations that these will not be representative of sites within the UK. This leads to the Assessment Finding below, which must be addressed by milestone 2 – first concrete.

AF-AP1000-CE-30 *The licensee shall carry out the NI raft foundation structural analyses with the correct site characteristics (e.g. soil strata, groundwater level and maximum site flood level) for the specific site application and justify the design of the raft.*

4.11.2 Sliding, Overturning and Uplift

4.11.2.1 Assessment

- 455 The nuclear island is checked for resistance against sliding and overturning due to the safe shutdown for earthquake, winds and tornados and against flotation due to floods and groundwater. Resistance to sliding of the concrete raft foundation is provided by passive soil pressure and soil friction. This provides the required factor of safety against lateral movement under the most stringent loading conditions.
- 456 The minimum required factors of safety are given in Table 3.8.5-1 of the EDCD with the calculated factors of safety given in Table 3.8.5-2. These are combined below in Table 15. The factor of safety is calculated for the same envelope of the six soil and rock sites described previously.
- 457 Although the factor of safety against sliding for the seismic load combinations is close to the minimum required, Westinghouse argues that *“the horizontal movement is negligible (0.03 inches, 0.762 mm without buoyant force consideration, and 0.045 inches (1.143 mm) with buoyant force considered)*.
- 458 Section 3.8.5.5.6 of the EDCD states that *“the effects of basemat uplift were evaluated using an east-west lumped-mass stick model of the nuclear island structures supported on a rigid basemat with nonlinear springs. Floor response spectra from safe shutdown earthquake time history analyses, which included basemat uplift, were compared to those from analyses that did not include uplift. The comparisons showed that the effect of basemat uplift on the floor response spectra is not significant.”*

Table 15

Factors of Safety for Floatation, Sliding and Overturning

	Environmental Effect	Factor of Safety	Minimum Required F of S
Flotation			
	High Ground Water Table	3.7	1.5
	Design Basis Flood	3.5	1.1
Sliding			
	Design Wind, North-South	14.0	1.5
	Design Wind, East-West	10.1	1.5
	Design Basis Tornado, North-South	7.7	1.1
	Design Basis Tornado, East-West	5.9	1.1
	Safe Shutdown Earthquake, North-South	1.1	1.1
	Safe Shutdown Earthquake, East-West	1.1	1.1
Overturning			
	Design Wind, North-South	51.5	1.5
	Design Wind, East-West	27.9	1.5
	Design Basis Tornado, North-South	17.7	1.1
	Design Basis Tornado, East-West	9.6	1.1
	Safe Shutdown Earthquake, North-South	1.77	1.1
	Safe Shutdown Earthquake, East-West	1.17	1.1

4.11.2.2 Summary and Findings

- 459 Overall, the factors of safety achieved for the design are reasonable. However, I note that passive soil pressure has been used for resistance to sliding, and this also results in the lowest factors of safety. Since passive pressure is reliant on the quality of backfill material and workmanship in compacting it, normal UK practice is to either ignore its contribution in design or use a much reduced contribution (earth pressure at rest).
- 460 The factors of safety for floatation are based on ground water level being at ground level. This depends on the maximum flood level being at ground level, which is one of Westinghouse's key assumptions (refer to Section 4.4.6.3). However, if the site specific flood level is higher and alternative flood protection measures are used (e.g. bunds) then the effect on floatation of the nuclear island should be considered. I do not believe this will be a problem since the current floatation factors of safety are high.
- 461 My conclusions lead to the Assessment Finding below which must be addressed by milestone 2 – first concrete.

AF-AP1000-CE-31: *The licensee shall justify that the generic factors of safety for sliding, overturning and uplift on the nuclear island foundation are still applicable for the site specific soil properties. Where the site specific soil properties are not*

bounded by the standard plant soil properties, the factors of safety shall be re-substantiated. The use of passive earth pressure on the sides of foundations in calculating resistance to sliding shall be justified or alternative calculation produced.

4.11.3 Settlement during Construction

4.11.3.1 Assessment

- 462 The design of the raft can be sensitive to the effects of differential settlement, induced due to different sequences of construction and differing soil conditions.
- 463 Section 16.14.5 of the 2010 PCSR (Ref. 1) (repeated from Section 3.8.5.4.2 of EDCD) refers to analyses of the effects of settlement during construction and recognises that construction loads, and the sequence of construction, have the potential to be significant to the foundation design, depending on the soil conditions present at a particular site. The analyses focus on the response of the raft in the early stages of construction when it is susceptible to differential loading and deformations.
- 464 Two types of soft-soil site are considered; a soft-soil site with alternate horizontal layers only of sand and clay, which maximises settlement in the early stages of construction and the effects of dewatering, and a soft-soil site with clay which maximises settlement during the later stages of construction and during operation. These are different to the range of soil sites considered by the main FE analysis (refer to Table 11).
- 465 The settlement analyses for these two sites have concluded that restrictions are required on the rate of construction of the Shield Building, relative to the Auxiliary Building and, vice versa, in the event of delays to construction of either building. The restrictions are due to the fact that for the base construction sequence, the largest moments and shears in the raft occur at the interface with the Shield Building before the connections between the Auxiliary Building and the Shield Building are credited.
- 466 Once the Shield Building and Auxiliary Building walls are completed to elevation 94.7m, the load path for successive loads changes and the loads are resisted by the raft which is now stiffened by the shear walls.
- 467 The two load cases considered show that;
- The raft can accommodate delays in the Auxiliary Building concreting so long as the Shield Building construction is suspended at elevation 95.1 m. This is necessary in order to limit tensile stresses in the bottom of the raft slab. Construction of the Shield Building can resume once the Auxiliary Building is advanced to elevation 100m.
 - The raft can also accommodate delays in the Shield Building providing that Auxiliary Building construction is suspended at elevation 105.182m (except for filling of the CA20 modules which is suspended at 110.74m). This is to limit tension stresses at the top of the raft slab. Construction of the Auxiliary Building can resume once the Shield Building is advanced to elevation 100m.
- 468 The 2010 PCSR notes that member forces in the raft during construction differ from those obtained from the design analyses. Although the bearing pressures at the end of construction are similar in the two analyses, the resulting member forces differ because of the progressive changes in structural configuration during construction. Using the results of the 3D analyses described in PCSR Section 16.14.4, the design is said to provide sufficient structural strength to resist the specified loads, including bearing reactions on the underside of the basemat.

- 469 To take into account the effect of locked-in forces due to construction settlement, a further evaluation has been performed by Westinghouse for critical locations where the effect of locked-in member forces were judged to be most significant. The governing scenario was taken to be the case with a delay in the Auxiliary Building construction for the soft-soil site with alternating layers of sand and clay. The delay is postulated to occur just prior to the stage where the Auxiliary Building walls are constructed. Member forces at the end of construction are calculated considering the effects of settlement during construction. The differences in these member forces, from those calculated for dead load in the analyses on soil springs, are added as additional dead loads in the critical SSE load combination.
- 470 For the five critical sections to the most heavily stressed members, the member forces for the load combination of dead load plus SSE (including the member forces locked-in during various stages of plant construction) lead to stresses that are shown to be acceptable with respect to the ACI 349-01 design criteria.

4.11.3.2 Summary and Findings

- 471 The foundation has been evaluated for differential settlement during construction for three types of generic site formation. This has shown that the foundation can resist the deformations, moments and shears due to settlement during the construction period, provided the specified construction sequence is followed. However, this raises two Assessment Findings relating to foundation settlement that need to be carried forward into the site specific phase of licensing. These must be addressed by milestone 2 – first concrete.

AF-AP1000-CE-32: *The licensee shall demonstrate that for the specific site application, the soil characteristics are bounded by the two differential settlement analyses described in Section 16.14.5 of the PCSR. In the event that bounding cannot be demonstrated, or where the strata are not horizontal, differential settlement shall be re-analysed with the appropriate FE model. The forces in the raft and members due to out of sequence construction shall be recalculated and the restrictions on the relative rates of construction of the Shield Building and Auxiliary Building shall be re-determined. The raft reinforcement design shall be revised accordingly.*

AF-AP1000-CE-33: *The licensee shall justify that the proposed procedures for settlement monitoring and assessment of construction progress comply with the design settlement analyses.*

4.11.4 Waterproofing

4.11.4.1 Assessment

- 472 Waterproofing is provided to the underside of the raft slab and to the side walls of the basement which is 40ft deep. Its function is to limit the infiltration of ground water into the concrete structures, although this is not claimed as safety related (Section 3.4.1.1.1.1 of EDCD).
- 473 The waterproofing under the slab is placed between 2 layers of blinding concrete each 150mm thick (Section 2.5.4.6.12 of EDCD). The waterproof membrane, or waterproofing system for the seismic class I structures, must provide adequate shear strength to transfer horizontal shear forces due to seismic (SSE) loading. It must maintain a friction

coefficient ≥ 0.55 with all unbonded concrete surfaces for the life expectancy of the plant so that it will not introduce a slip plane increasing the potential for movement during an earthquake. This function is stated as being Class I (Section 3.4.1.1.1.1 of EDCD).

4.11.4.2 Summary and Findings

474 The Class I function for the waterproofing has been reasonably considered by Westinghouse. However, since the final selection of waterproofing product will not be made until just prior to construction, this is a site specific issue. I therefore raise the Assessment Finding below which must be addressed before milestone 2 – first concrete.

AF-AP1000-CE-34: *The licensee shall justify that the waterproofing product, selected for the underside of the nuclear island foundation raft, provides adequate shear strength to transfer horizontal shear forces due to seismic (SSE) loading. This function is seismic Category I. The licensee shall provide details of the waterproof membrane for safety critical structures in terms of its effectiveness, practicability and longevity.*

475 With respect to the back fill detail described in paragraph 480, casting the basement walls against vertically excavated sides primed with waterproofing has the disadvantage that neither the waterproofing, nor the external concrete face, can be inspected for construction defects. I have captured this below under **AF-AP1000-CE-37**.

4.11.5 Ground Water

4.11.5.1 Assessment

476 Westinghouse states that the foundation raft and basement walls are designed for upward and lateral pressures from ground water. The maximum groundwater level is assumed to be coincident with ground level, i.e. the same as the maximum generic site flood level. A simple triangular pressure distribution is assumed being maximum (=height x unit weight of water) at the base and zero at the top. There are no dynamic water forces associated with the probable maximum flood or high ground water level because they are below the finished grade. Dynamic forces associated with the probable maximum precipitation are not factors in the analysis or design since the finished grade is adequately sloped (Section 3.4.1.2.1 of EDCD).

4.11.5.2 Summary and Findings

477 The calculation of water pressure on the basement walls is acceptable, provided the maximum flood level does not exceed the nominal ground level of 100.00m.

478 The site roads and hardstandings will need to be designed to prevent ponding of rain water in order to satisfy this and to prevent water entering the building and leading to internal flooding (refer to Internal Hazards Assessment Report, ONR-GDA-AR-11-001, Ref. 35). This is captured in the Assessment Finding below, which must be addressed before milestone 3 – NI safety related concrete.

AF-AP1000-CE-35: *The licensee shall justify that the design of site roads and hard standings does not lead to ponding of surface water, such that it rises above the maximum flood level claimed.*

4.11.6 Backfill

4.11.6.1 Assessment

479 Section 2.5.4.1 of the EDCD states the following:

480 *Excavation for the nuclear island structures below grade may use either a sloping excavation or a vertical face as described in subsequent paragraphs. If sloping excavations are to be used on a soil site, the Combined License applicants must perform site-specific SSI analyses that reflect the sloping excavations. If backfill is to be placed adjacent to the exterior walls of the nuclear island, the Combined License applicant will provide information on the properties of backfill and its compaction requirements as described in [EDCD] subsection 2.5.4.6.3 and will evaluate its properties against those used in the seismic analyses described in [EDCD] subsection 3.7.2."*

481 The EDCD describes the preferred method of using an excavated, vertical face which "will be covered by a waterproof membrane and is used as the outside form for the exterior walls below grade of the nuclear island."

4.11.6.2 Summary and Findings

482 The preferred method of vertical excavation is really only applicable to a hard rock site. It is an unusual form of construction in the UK where an excavation of 12m depth in soft soils is just as likely to be constructed using side slopes. I am surprised Westinghouse has stressed that adoption of side slopes with backfill could have a significant effect on the seismic design and stability of the nuclear island. However, their design basis is clear in the EDCD and so it is a site specific issue and is raised as the Assessment Findings below, which must be addressed before milestone 3 – NI safety related concrete.

***AF-AP1000-CE-36:** The licensee shall justify that the proposed form of excavation for the nuclear island raft and basement, is bounded by the design as stated in section 2.5 of the EDCD. In the event that bounding cannot be demonstrated, then 1) the effect of backfill and soil properties on the seismic analyses shall be determined and if necessary shall be re-analysed with the appropriate FE model; 2) all consequential effects from this re-analysis shall be included in the final design, including factors of safety for sliding, and the effect on the design of the basement walls from lateral earth pressures.*

***AF-AP1000-CE-37:** The licensee shall justify that the proposed method of construction of the basement walls allows for post construction inspection and remediation of potential defects in the concrete wall and the external waterproofing. For instance, the protection measures to be used to prevent damage to the waterproofing from concreting works or backfilling as appropriate.*

4.12 Containment Vessel

4.12.1 Assessment

483 The containment vessel (CV) as such, is not included in the civil engineering assessment, but is assessed by the Structural Integrity Inspectors (refer to ONR-GDA-AR-11-011, Ref. 46). My assessment has therefore focused on the interfaces between the CV and the civil structures surrounding it.

-
- 484 A description of the CV is given in Section 3.3.2 of this report with the appropriate Westinghouse references. Further information, from Section 3.8.2.1.2 of the EDCD, is as follows:
- 485 *“The bottom head is embedded in concrete, with concrete up to elevation 100' (100.000 m) on the outside and to the maintenance floor at elevation 107'-2" (102.184 m) on the inside. The containment vessel is assumed as an independent, free-standing structure above elevation 100' (100.000 m). The thickness of the lower head is the same as that of the upper head. There is no reduction in shell thickness even though credit could be taken for the concrete encasement of the lower head.*
- 486 *“Vertical and lateral loads on the containment vessel and internal structures are transferred to the basemat below the vessel by shear studs, friction, and bearing. The shear studs are not required for design basis loads. They provide additional margin for earthquakes beyond the safe shutdown earthquake.*
- 487 *“Seals are provided at the top of the concrete on the inside and outside of the vessel to prevent moisture between the vessel and concrete. A typical cross section design of the seal is presented in Figure 3.8.2-8, sheets 1 and 2.”*
- 488 The layout drawings presented in Section 1.2 of the EDCD indicate that the operating floor inside the CV was connected to it (refer to Figure 4 of this report). I queried this at a civil engineering technical meeting in Pittsburgh in September 2010. Westinghouse confirmed, by demonstrating their 3D model, that the operating floor is supported by steel columns around the perimeter. I am therefore satisfied there is no load transfer to the CV from the operating floor.
- 489 There is a water tight seal between the inside of the ESB circular wall and the CV to separate the upper annulus and the middle annulus at level 109.830m (refer to paragraph 105). This has a significant safety function, since the middle annulus contains the majority of containment penetrations and radioactive piping. The final detailing of this, including exact sealant products, will be a site specific item and **AF-AP1000-CE-38** is raised accordingly.
- 490 The main interface with the CV is at the base where the bottom head is encased in concrete both above and below. A seal is provided where the concrete is cast up against the vessel, both inside and outside. Any steel structure that is cast into a concrete floor, is more susceptible to corrosion at the joint than in an open building environment. The CV thickness is increased from 44mm to 47.6mm in this region as a corrosion allowance. The CV is also coated with corrosion protection for approximately 300mm into the concrete embedment on the inside face, but not the outer (refer to Structural Integrity Assessment Report, ONR-GDA-AR-11-011 Section 4.7.2.2, Ref. 46). The outer face should have the required protection for the design life of the CV, provided the seal is adequately inspected and maintained.
- 491 This seal between the vessel and concrete will need to accommodate some movement due to expansion, although I anticipate this will be less than normal building movement joints usually need to tolerate. The detail given in EDCD Figure 3.8.2-8, sheets 1 and 2 is not well developed and so more detail was requested via TQ-AP1000-732. However, this still did not give full details so this will become part of the site specific design and **AF-AP1000-CE-39** is raised accordingly.
- 492 The concrete inside is cast to a higher level than the concrete outside the CV. The level difference is approximately 2.2m (Figure 3.8.2-8 of EDCD). This level difference will induce lateral pressures on the CV wall during concrete placement. I consider these are
-

unlikely to be greater than the vessel design pressures. However, since this concrete will be cast before the vessel is complete, there may be local effects. The construction methods and procedures will not be confirmed until a contractor is appointed. This is a site specific item and I have raised **AF-AP1000-CE-40**.

493 The stability of the CV is provided by shear studs, friction and bearing between the bottom head and the concrete cast beneath it. I have not reviewed the factors of safety against sliding and overturning for this, but I do not consider this to be of concern since the immense weight of the CV and in-containment structures (plus the large surface area of the bottom head) should ensure there will be plenty of margin against the lateral forces that need to be resisted.

494 The installation of the bottom head will require a steelwork grillage to support it whilst the concrete below is cast. The pouring of the concrete must ensure that any voids beneath the plate caused by construction defects, are within the allowable for the CV plate design. The construction methods and procedures will not be confirmed until a contractor is appointed. This is a site specific item and I have raised **AF-AP1000-CE-41** accordingly.

4.12.2 Findings

495 The construction details of the watertight seal between upper and middle annuli, will need to be assessed at site specific stage to ensure it performs its function of preventing water in the upper annulus from entering the middle annulus. This is captured in the following Assessment Finding which must be addressed prior to milestone 3 – NI safety related concrete.

AF-AP1000-CE-38: *The licensee shall provide the final details for the water tight seal between upper annulus and lower annulus of the Shield Building in terms of its effectiveness, practicality and longevity. The licensee shall justify that the seal detail will satisfy the safety functions of preventing water ingress into the middle annulus and that it can and will be maintained appropriately.*

496 The seal between the concrete encasement and the CV is not sufficiently detailed at this stage. Therefore, it will need to be designed at site specific stage and I therefore raise the following Assessment Finding which must be addressed prior to milestone 3 – NI safety related concrete.

AF-AP1000-CE-39: *The licensee shall provide the final detail for the water tight seal between the concrete structure and the containment vessel in terms of its effectiveness, practicality and longevity. The licensee shall justify that the seal detail will satisfy the safety functions of preventing water ingress into the joint and thus preventing corrosion of the CV. The licensee shall also justify that the joint can and will be maintained appropriately.*

497 Construction methods and procedures are site specific items. The effect of potential differential pressure on the CV during concrete placement is covered by the Assessment Finding below, which must be addressed prior to milestone 3 – NI safety related concrete

AF-AP1000-CE-40: *The licensee shall justify that the concrete placement pressures, due to floor level differences at the base, do not overstress the CV plate in its temporary or permanent condition.*

498 Assessment of the installation of the bottom head and pouring of concrete below, leads to the following Assessment Findings which must be addressed prior to milestone 3 – NI safety related concrete.

AF-AP1000-CE-41: *The licensee shall justify that the steelwork support grillage to the CV bottom head does not affect the integrity of the CV, particularly during installation and construction works.*

AF-AP1000-CE-42: *The licensee shall justify that concrete placement beneath the CV bottom head does not result in construction defects that will affect the CV plate integrity, e.g. voids in concrete must be within allowable for the plate to span over them.*

4.13 Containment Internal Structures

4.13.1 Introduction

499 The AP1000 containment internal structures, as submitted by Westinghouse, are described in Section 3.3.3 of this report. The key parts of the civil structures are as follows:

- Reinforced concrete ‘slab’ to make up levels from bottom dome of the containment vessel to required floor level.
- CA Modules comprising:
 - steel modules used as permanent formwork, e.g. CA04 for the reactor pit;
 - SC modules used as support structures, e.g. CA01 for in containment structures;
 - steel modules used as structural walls, e.g. CA03.
- IRWST water tank, which is formed by CA01 and CA03.
- operating deck comprising:
 - composite steel/concrete floor slab;
 - structural steel platforms.

500 My assessment has focused on the design methodology of the SC structures, which I consider to be outside the applicability of the code claimed. This is detailed in Section 4.16.7 of this report and has led to a GDA Issue, **GI-AP1000-CE-01**.

501 My assessment also includes a detailed sample of the load schedule application to the CA Modules and the IRWST tank, which is detailed in this section. This work was supported by ABSC (Ref. 27). Consideration of the leak detection details of the steel portion of the IRWST is covered by the assessment of the Spent Fuel Pool containment (Section 4.17).

502 I have not carried out a detailed sample of the reinforced concrete structures or steel structures, but have satisfied myself that the design codes used for these are established and appropriate (refer to Section 4.3 of this report).

4.13.2 Assessment of SC Design Methodology

503 The CA Modules within containment comprise SC composite structures. This has been assessed jointly with the enhanced Shield Building SC wall since the design methodology is very similar. Therefore, this assessment is presented separately in Section 4.16.7.

4.13.3 Load Schedule Application to CA Modules

4.13.3.1 Introduction

504 This section concentrates on the load schedule application to the design of the Containment Internal Structures (CIS). The majority of external hazards are not applicable to in-containment since they lie within the cover of the containment vessel and Shield Building. It is apparent that the only external event that would directly act upon the CIS is seismic. The main load cases result from Internal Hazards and the applicability of these has been assessed in report ONR-GDA-AR-11-001, Ref. 35).

505 Documentation for assessment was obtained via TQ-AP1000-069, 319, 727, 1079 and during design audit meetings at Westinghouse UK offices on 7 January 2011. The main references are:

- APP-GW-C1-001 Revision 1. AP1000 Civil/Structural Design Criteria (Ref. 81).
- APP-GW-SUP-001 Revision 2. Design Methodology for Structural Modules (Ref. 86).
- APP-1100-S3R-002 Revision A. Design Report for AP1000 Modules (Ref. 143).
- APP-1100-S3R-001 Revision 3. AP1000 Design Summary Report: Containment Internal Structures (Ref. 144).
- APP-1100-S2C-006 Revision 3. Static Analysis of Containment Internal Structures – Load Combinations (Ref. 145).
- APP-1100-S2C-034 Revision 0. Finite Element Solid-Shell Model of Containment Internal Structures (Ref. 146).

4.13.3.2 Loads

506 The 'standard' list of loads and load combinations is given in the Civil/Structural Design criteria (Ref. 81). The Design Methodology for Structural Modules (Ref. 86) describes the design methodology for the structural modules and supplies an outline list of the design loads required to be applied in addition to those in Ref. 81. These supplemental design loads are:

- F_n - hydrostatic loads, which are treated as Dead Loads, based on water levels as defined in Section 4.1.1 of Ref. 86.
- Automatic Depressurisation System (ADS) loads for two cases, as defined in Section 4.1.2 of Ref. 86;
 - ADS1 is associated with blowdown of the primary system through the spargers when the water in the in-containment refuelling water storage tank (IRWST) is cold and the tank is at ambient pressure. ADS1 is of short duration such that the concrete walls do not heat up significantly. A uniform pressure of 34.5kN/m^2 (5psi) applied to the walls bounds the hydrodynamic pressure. This pressure is taken as both positive and negative due to the oscillatory nature of the hydrodynamic loads.
 - ADS2 considers heatup of the water in the IRWST. This may be due to prolonged operation of the passive residual heat removal heat exchanger or due to an ADS discharge. For the former, the IRWST temperature rises from 10°C ambient to 126°C in about 10 hours. A blowdown through the spargers cannot fully condense in these saturated conditions and so the pressure increases in the IRWST and steam is vented through the tank roof vents. The IRWST is thus designed for an equivalent static internal pressure of 34.5kN/m^2 , in addition to the

hydrostatic pressure occurring at any time up to 24 hours after the initiation of the event.

- Pa – accident pressure loads. A sub-compartment differential pressure load is accounted for by applying a 34.5kN/m^2 pressure to the modules. Five different configurations of pressure loads are considered.
- Hydrodynamic loads, due to water inertia and sloshing during the SSE, are applied to the walls of the IRWST. These are calculated within the seismic FE models (see Section 4.9) and so are included in the seismic force loadcases.
- To - normal thermal transients. This is taken to be the temperatures resulting from the ADS2 scenario above, since this maximizes the temperature gradient across the concrete-filled structural module walls. The water in the IRWST rises from an ambient temperature of 10°C to saturation in about 4 hours, increasing to about 126°C within about 10 hours.
- Ta - accident thermal transients - are considered to occur when the IRWST has drained. The temperature of the containment atmosphere shows a peak temperature of 193°C and reduces below 126°C at 10000 seconds (= 2.78 hours). This is considered short term temperature transients and thus Westinghouse states it does not affect the structures due to the thermal inertia of the concrete and the IRWST water.
- Concrete placement loads.

507 There is no definitive statement within the documents reviewed as to how external hazards were screened out. However, as the CIS are within the Shield Building, the only relevant external hazard is the Safe Shutdown Earthquake, Es.

508 Section 4.2 of Ref. 145 states that "*Accident pipe reactions (Yr), Jet impingement (Yj) and Pipe Impact loads (Ym) have not been considered and have been excluded*". This is because Westinghouse claims these are not relevant to the CIS structures. This section also states that "*the Automatic Depressurization System loads have been considered as accidental load conditions. These loads have been considered in absolute value and combined to consider the loads in opposite directions*".

509 The ONR Internal Hazards assessment (Ref. 35) has sought evidence to substantiate the hazard barrier matrix but has concluded that the safety case for pressure part failures, internal explosion, internal missiles and dropped loads and impacts are not adequate (refer to Section 4.5). The resolution of the internal hazards GDA Issues (Ref. 52 to Ref. 57) could affect the civil structures load schedule. Therefore, my assessment currently accepts the load schedule on face value and considers the suitability of the application of these loads.

510 Static assessments have been performed by Westinghouse to calculate the CIS response to individually applied load cases. The assessments are presented as follows:

- Dead load and Live load (Ref. 147).
 - Hydrostatic and Other Pressures (Ref. 148).
 - Seismic sloshing loads (Ref. 149)
 - SSE equivalent static accelerations (Ref. 150).
 - Thermal Analyses (Ref. 151).
 - Equipment and Piping Reactions (Ref. 152).
-

4.13.3.3 Thermal Loads

- 511 There are anomalies between the documentation with respect to normal (T_o) and accident (T_a) thermal loads. Section 1.1 of Ref. 151 states the “*Accident thermal load T_a is enveloped by T_o which considers IRWST water temperatures up to 260° F*” therefore T_o is considered as the governing thermal case. This is accepted in relation to the T_a loads stated in Civil/Structural Design Criteria, which define them as being “*due to temperature gradients caused by the postulated pipe breaks*”. Westinghouse claims that T_a is bounded by the normal thermal event as no other pipework exists in the CIS whose failure would lead to a greater temperature than 260°F being attained. This claim has yet to be substantiated (refer to Section 4.5).
- 512 The thermal transients arising from the ADS2 case are considered by Westinghouse to occur a few times during the lifetime of the plant and so are considered as normal. I requested clarification on this and Westinghouse confirmed in their letter UN REG WEC 000457 (Ref. 135) that the frequency of occurrence was 2.75×10^{-2} /year albeit calculated conservatively. Therefore, I agree it should be considered as a normal event. The claim that the T_a is bounded by the T_o however, needed to be justified further since this appeared to be a global statement rather than specific to the CIS. Westinghouse has carried out a further study on thermal loading for the CIS, but this was submitted on 1 March 2011 (Ref. 153) and thus was too late to be included in this assessment. GDA Issue Action **GI-AP1000-CE-01.A5** requires Westinghouse to progress this information.

4.13.3.4 Hydrodynamic Loads

- 513 Water contained in tanks will exert additional loads during a seismic event due to water inertia and sloshing. Westinghouse’s approach to sloshing was requested and the response given in letter UN REG WEC 000466 (Ref. 154). Page 5 of the response stated “*To avoid double counting the effect of the seismic load due to the inclusion of the water mass and water sloshing pressure, it is necessary to determine an equivalent pressure for each wall that should be subtracted from the water sloshing seismic pressure.*” This is a direct quote from Section 8.2 of Ref. 149.
- 514 The water is modelled by lump masses at the nodes of the IRWST walls, which act in the horizontal direction as well as the vertical to mimic the static water pressure. However, the seismic induced sloshing calculation predicts the pressure induced on the IRWST walls by the known mass of water. To apply the sloshing pressure to the existing FE model would result in the mass of the water being counted twice. Therefore, either the nodal masses can be removed or the sloshing pressures reduced. Westinghouse has chosen to reduce the sloshing pressure. I consider this to be an acceptable method of removing the possibility of double-counting the hydrostatic loads.

4.13.3.5 Load Combinations

- 515 The CIS are defined as seismic C-I structures, therefore the load combinations for the concrete structures are based on Table 3 of Civil/Structural Design criteria (Ref. 81) with the steel structures being based on Table 4. However, Section 4.2 of Ref. 145 states “*All the loads listed [in Tables 3 and 4 of Civil/Structural Design Criteria] are not necessarily applicable to all structures and their elements. Loads for which each structure is designed are dependent on the conditions to which that particular structure is subjected.*”

- 516 Ref. 145 summarises the actual load combinations used for the CIS in Table 4-1 for concrete structures and Table 4-2 for steel structures. These are repeated below in Table 16 and Table 17.

Combination #		1	3	5	6	7
Load Description						
Dead	D	1.4	1.0	1.0	1.0	1.05
Liquid	F	1.4	1.0	1.0	1.0	1.05
Live	L	1.7	1.0	1.0	1.0	1.3
Normal reaction	R _o	1.7	1.0			1.3
Normal Thermal	T _o					1.2
SSE	E _s		1.0		1.0	
Accident Pressure	P _a			1.4	1.0	
Accident thermal	T _a			1.0	1.0	
Accident reaction	R _a			1.0	1.0	

Table 16: Load Combinations and Load Factors - CIS Concrete Structures.

Combination #		1	3	5	6	7
Load Description						
Dead	D	1.0	1.0	1.0	1.0	1.0
Liquid	F	1.0	1.0	1.0	1.0	1.0
Live	L	1.0	1.0	1.0	1.0	1.0
Normal reaction	R _o	1.0	1.0			1.0
Normal Thermal	T _o		1.0			1.0
SSE	E _s		1.0		1.0	
Accident Pressure	P _a			1.0	1.0	
Accident thermal	T _a			1.0	1.0	
Accident reaction	R _a			1.0	1.0	
		Stress Limit Coefficient				
Except for Compression		1.0	1.6	1.6	1.7	1.5
For Compression		1.0	1.4	1.4	1.6	1.3

Table 17: Load Combinations, Factors and Stress Limits - CIS Steel Structures.

- 517 Load factors for the concrete structures are in accordance with ACI 349 and so are satisfactory. All load factors for steel structures are equal to 1.0 since the steel design code is a working stress code and so this is acceptable.
- 518 It should be noted that both T_o and T_a loads are included in these tables, despite the accidental thermal load being considered enveloped by the normal thermal. Section 4.2 of Ref. 145 states "*Since Normal thermal load (T_o) envelopes Accident thermal load (T_a), the later have not been deleted*". This anomaly will be investigated under GDA Issue Action **GI-AP1000-CE-01.A5**.

4.13.4 Deep Sample of Hydrodynamic Load on IRWST

519 A deep sample was undertaken of the calculation of the pressure load resulting from hydrodynamic effects on the module CA03, which is a circular steel wall to the west of the IRWST. The key documents are:

- APP-1100-S2C-009, IRSWT Seismic Sloshing and Wall Flexibility (Ref. 149).
- APP-1100-S2C-006 Revision 3 Static Analysis of Containment Internal Structures – Load Combinations (Ref. 145).

520 For the purpose of the deep sample, the reaction of the steel CA03 structure to Load Combination 1 was considered:

LC1 = 1.0 Dead + 1.0 Liquid + 1.0 Live + 1.0 Normal Reaction.

521 Figure B.2-39 of Ref. 145 presents the stress intensity distribution for the CA03 wall for LC1. This clearly shows the expected pattern of stresses, which delineate the steel panels between the vertical steel supports and results from an out-of-plane load applied normally to the surface, i.e. the hydrodynamic loads. Localised high stresses are apparent at the top of the wall due to the horizontal stiffeners and bracings. Similarly, there are high stresses at the base of CA03 where it is restrained by the floor connection.

522 A simple hand calculation (Ref. 27) was carried out as a check on the magnitude of stresses resulting from the Westinghouse FE analysis. The calculation is considered acceptable as *“an indication of the localised effect of the hydrodynamic load at the mid-height of the IRWST wall. The “wave” deformation shown in Figure B.2-39 is suggestive of the fact that at the mid-height the hydrodynamic pressure is the dominant load”* (section 5.4.6.1 of Ref. 27).

4.13.5 Findings

523 I am broadly satisfied that the load schedule has been applied correctly to the design of the containment internal structures. The derivation of the load schedule with respect to internal hazards still requires to be justified and this is captured in GDA Issues **GI-AP1000-IH-03 to 06** (Ref. 54 to Ref. 57, refer to Section 4.5).

524 My findings on the structural design of the SC modules are presented in Section 4.16.7.

4.14 Enhanced Shield Building

4.14.1 Description of Structure

525 The AP1000 Shield Building, as submitted by Westinghouse, is described in Section 3.3.4 of this report. The figure showing a section through the building is repeated as Figure 10 below.

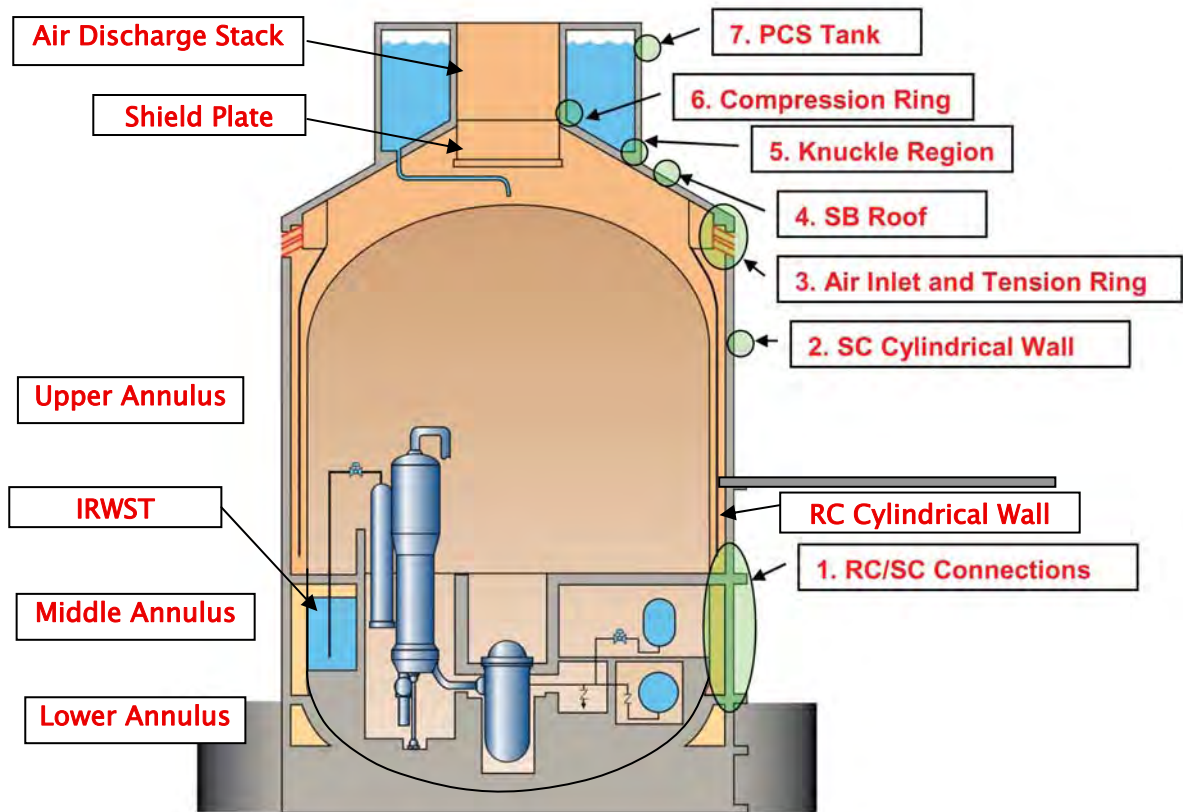

Figure 10: Typical Section Through Shield Building

526 The key parts of the civil structure, from the bottom up, are as follows:

- Common foundation with the Auxiliary Building comprising a 1.8m thick, reinforced concrete raft.
- Reinforced concrete 'slab' to make up levels to approximately ground floor level.
- Cylindrical Shield Building wall comprising:
 - reinforced concrete where the wall is inside the Auxiliary Building (lower levels on the east side);
 - SC construction where the wall is outside the Auxiliary Building (from ground to roof level on west and above the Auxiliary Building roof on the east).
- A conical roof comprising radial steel rafters supporting a reinforced concrete roof slab.
- The Passive Cooling System (PCS) water tank.
- Shield plate and valve roof suspended below the roof.

527 The key documents describing Westinghouse's submission for the Shield Building are as follows:

- APP-1200-S3R-003 ESB Design Report (Ref. 72).

- APP-1278-CCC-001 Revision 1, Enhanced Shield Building Roof Design. (Ref. 155).
- APP-1278-CCC-002 Revision 0, AP1000 Design Summary Report: Shield Building Roof. (Ref. 156).
- APP-1277-S1-001 Revision A. Structural Design Basis, Functional Specification, Modularisation and Construction Sequence for Shield Building Roof and Associated Structures (Ref. 157).

4.14.2 Assessment Process

528 My assessment of the Shield Building has focused on a number of areas. The most significant ones are:

- The design methodology of the SC modules (i.e. the cylindrical SC wall), which I consider to be outside the applicability of the code claimed. This is detailed in Section 4.16.8 of this report and has led to a GDA Issue, **GI-AP1000-CE-02**.
- Review of roof design and tension ring.
- The details of the PCS water tank.
- The details of the shield plate.

529 The structural analysis and the design of the foundation slab are covered separately in sections 4.9 and 4.11 respectively.

530 Several technical queries were raised on the ESB during Step 4. These were as follows:

- 741 Shield Building – shear resistance of tie bars.
- 902 Shield Plate – request for information.
- 903 PCS water storage tank – request for information.
- 994 Civil Engineering Design Criteria, illustrated by accidental torsion.
- 1042 ESB – cladding to outside.
- 1085 Enhanced Shield Building – table of queries on ESB design report APP-1200-S3R-003 Revision 2.
- 1134 Allowance for rocking motions in the seismic analyses for AP1000.
- 1176 Shield Building – tie bar function.

531 The most relevant of the above TQs to this section of my report is TQ-AP1000-1085, which contained a table of detailed questions on Revision 2 of the ESB design report (Ref. 72).

4.14.3 RC Cylindrical Wall

532 The RC cylindrical wall to the Shield Building has been assessed as follows:

- Review of design codes for Class I structures (refer to Section 4.3).
- Assessment of load schedule derivation and application (refer to Section 4.4.7).
- Assessment of FE analyses for ascertaining design forces (refer to Section 4.9).

533 I have not carried out a detailed sample of the design calculations for the reinforced concrete part of this wall. I have satisfied myself that the design codes used for this are established and appropriate (refer to Section 4.3 of this report).

4.14.4 Roof

4.14.4.1 Assessment

534 The detailed design was carried out by one of Westinghouse's design partners, Ansaldo Nucleaire S.p.A., which is based in Italy. Ref. 155, Ref. 156 and Ref. 157 date from 2008 and were authored by Ansaldo. The ESB Design Report was revised in 2010 and is therefore more current, although much of its description of the roof design is the same as that used in the earlier reports.

535 Document APP-1278-CCC-001 Revision 1 Enhanced Shield Building Roof Design (Ref. 155) describes the roof design. The Shield Building roof consists of 32 radial steel beams that are composite with the concrete slab above. The slab is designed as reinforced concrete. The steel beams act to support the concrete during construction but utilise the compressive strength of the concrete in the completed structure. Construction load analysis and verification of the composite beams and some connections is dealt with in other studies. I have not sampled these other studies.

536 Section 7.2.2 of Ref. 155 confirms that the roof is designed for the appropriate loads for a Class I structure which are as follows:

- Dead (D).
- Liquid (F) for both hydrostatic and hydrodynamic loads considering the maximum water level inside the tank.
- Live (L), which includes snow, in accordance with ASCE 7-98.
- Wind (W) in accordance with ASCE 7-98.
- Tornado (Wt).
- Missile load (M).

537 Two questions were raised during my assessment with respect to the connection between the roof and the compression ring at the top (Figure 6.1-5 of Ref. 72). These were questions 53 and 54 of TQ-AP1000-1085. Question 53 questioned how the forces were transferred at the change in angle of the radial steel beam, since the usual detail for this would require a stiffening plate. Question 54 requested justification of the reinforcement detailing and anchorage of bars. The Westinghouse response included a more detailed drawing that indicates a more appropriate arrangement.

4.14.4.2 Findings

538 The roof has been designed and reinforced as a normally reinforced concrete slab and the steel rafters are designed to the appropriate composite steel design codes. Therefore, I am broadly satisfied that the roof design has been carried out satisfactorily and I have no findings to make on this structure.

4.14.5 Tension Ring

4.14.5.1 Assessment

- 539 The tension ring is described in Section 5.1 of the ESB Design Report (Ref. 72) as “a concrete filled box girder” and “the primary function is to resist the thrust from the shield building roof”. The plates are generally 38mm thick (1.5 inches) and have nelson studs and tie bars welded to the inside faces to interface with the concrete. However, “though its steel plates are connected to the concrete infill by studs and tie-bars, the tension ring is conservatively designed as a hollow steel box girder. The concrete infill is only credited for stability of the steel plates. The tension ring is designed to have high stiffness and to remain elastic under the required load combinations.”
- 540 The tension ring sits directly onto the air inlet region of the top of the Shield Building wall. Westinghouse gives an outline construction method statement for concreting the air inlet region up to 200mm below the top. The tension ring will then be lifted into place and welded. Vent holes will be present to facilitate concrete placement. Westinghouse presented a video to ONR of the test pour for this region in the technical meeting in November 2010.
- 541 The tension ring has been reviewed at a high level rather than a detailed sample.
- 542 Section 5.2.1 of Ref. 72 describes the design methodology for the tension ring. The vertical and horizontal thrusts from the roof will tend to push the top of the cylindrical wall outwards. The tension ring resists these forces by the inner and outer vertical plates, acting as beam flanges and the horizontal connecting plates acting as webs. The design is to US steel code AISC/ANSI N690 (Ref. 96) which is an allowable stress code.
- 543 The forces used for the design are from the roof quarter model (see Section 4.9) which is a linear elastic analysis. Tables 5.2-1 and 2 of Ref. 72 show a design ratio of demand versus capacity for the steel plates of 70% for axial plus bending and 20% for shear plus torsion.

4.14.5.2 Findings

- 544 Since the tension ring is designed as a steel structure using established codes, I have not sampled deeply and accept the design is suitable on that basis.

4.14.6 Compression Ring

4.14.6.1 Assessment

- 545 The compression ring supports the top of the conical roof beams and the inner wall of the PCS water tank. It comprises a curved steel beam, which supports the roof steel module during construction and concrete pouring. The steel beam has studs welded to its top flange, such that the concrete section above it will act compositely with it. (Section 6.1.2.3 of Ref. 72).
- 546 The composite design is to AISC/ANSI N690 (Ref. 96) and is a conventional design method.

4.14.6.2 Findings

547 Since the compression ring is designed as a steel beam acting compositely with the reinforced concrete section above it using established codes, I have not sampled deeply and accept the design is suitable on that basis.

4.14.7 PCS Water Tank

4.14.7.1 Assessment

548 The Step 4 assessment plan (Ref. 11) stated that the design of the supporting structure and local details of the passive cooling system (PCS) water tank required detailed scrutiny. TQ-AP1000-903 was raised and the subject was discussed at the technical meeting in Pittsburgh in September 2010. The roof structure, including the PCS water tank, was designed by Ansaldo Nucleaire.

549 In its response to TQ-AP1000-903, Westinghouse states that "*the PCS tank is a seismic [class] I structure and is thus designed to the appropriate requirements and load cases defined in the Civil/Structural Design Criteria document APP-GW-C1-001, Rev.1*" (Ref. 81). Document APP-1277-S1-001 Revision A, Structural Design Basis, Functional Specification, Modularisation and Construction Sequence for Shield Building Roof and Associated Structures (Ref. 157) was provided as a detailed calculation. Reference was also given to the ESB Design Report (Ref. 72), specifically Figure 6.1-4 and Figure 6.1-6, which show the RC details of the tank and the liner.

550 The following description is obtained from Section 6.2.2.4 of Ref. 72 and Section 2 of Ref. 157. The tank is constructed out of reinforced concrete and is built up from the sloped ESB roof. It is a donut shape, with the central hole forming the roof vent. There is a stainless steel liner on the inside surfaces of the tank, which provides a leak-tight barrier, and has leak chase channels provided over liner welds. The tank is to be cast in-situ once the main roof has been cast. Formwork will be used for the outer faces but the liner can be used as formwork for the inner faces.

551 Ref. 157 confirms that the PCS tank is designed as a conventional reinforced concrete structure in accordance with ACI 349, with no credit taken for the strength provided by the liner. AISC/ANSI N690 is used for the design of the stainless steel liner.

552 Section 7.2.2 of Ref. 155 confirms that the PCS tank is designed for the appropriate loads for a Class I structure, which are the same as those for the ESB roof.

553 The seismic modelling of the whole Shield Building is described in Section 4.9 of this report. The water within the PCS tank has been modelled in the same way as that described for the CIS in Section 4.13.3.4 and this is satisfactory.

4.14.7.2 Summary and Findings

554 I conclude that the concrete walls are designed as normally reinforced concrete. The liner provides the water retention and is non-structural. The RC tank walls provide support to the liner and do not need to be designed as water retaining concrete, i.e. designed to limit crack widths in accordance with BS EN 1992-3 Eurocode 2 Liquid-retaining and containment structures (Ref. 158).

555 I agree that since the water contained is towns water, no secondary containment is required and so the walls do not need to be designed as water retaining concrete. Water retention is provided by the liner alone and this is acceptable. Provision of leak chases is

purely for operational reasons, i.e. to confirm if any welds are leaking, however this could be satisfactorily performed by level indication.

556 I am broadly satisfied with the reinforcement detailing shown in Figures 6.1-4 to 6 of Ref. 72 and have no comments to make on this.

557 I am broadly satisfied with the FE analysis approach used by Westinghouse in order to calculate demand forces and moments. Since the PCS tank adds considerable weight to the top of the Shield Building, it could induce rocking in the whole system. The assessment of this aspect is presented in Section 4.9 of this report.

4.14.8 Shield Plate

4.14.8.1 Assessment

558 The shield plate is a suspended slab which is hung from the underside of the Shield Building roof so that it is above the top of the CV (See Section 3.3.4 on Shield Building). Since this has the potential to become a drop load and would drop onto the top dome of the CV, I undertook a detailed sample of its support structure.

559 The shield plate is only mentioned once in the 2010 PCSR at Section 12.11.2.3, which states that "*The system also provides for heating the chimney base plate (shield plate) to keep that region clear of ice and snow and prevent any air-flow blockage.*"

560 Document APP-1278-CCC-001 Revision 1 Enhanced Shield Building Roof Design (Ref. 155) states that the shield plate is designed for snow loading (Section 4.5.3), wind uplift (App A2), tornado (App A3) and seismic loads (App A4).

561 TQ-AP1000-902 was raised to request the details of the safety functional requirements, design and analysis and construction details for the shield slab. In its response, Westinghouse states that "*The primary purpose of the shield slab is to ensure radiation protection in the external environment and to provide tornado missile protection.*"

562 TQ-AP1000-902 states that the shield plate has "*an octagonal shape characterized by internal equivalent radius equal to 17 feet (radius to columns) and thickness equal to 2 feet. [It is] anchored to the conical roof through eight vertical columns. Cross bracing between the vertical columns is installed. In addition, a wire mesh system above the shield plate, rigidly connected to the vertical columns, is provided. The connection between the compression ring of conical roof and shield plate will be bolted connection. This is documented in APP-1277-S1-001, Revision A. Additional design information for the Shield Building roof is documented in APP-GW-GEE-1119. Section 6 of APP-1200-S3R-003, Revision 2 also shows detailed figures of this area.*"

563 The design document APP-1277-S1-001 Revision A (Ref. 157) was produced by Ansaldo Nucleaire, who were responsible for the Shield Building roof design. At a civil technical meeting in Pittsburgh in September 2010, the designers from Ansaldo presented their design of the shield slab as documented in Ref. 156 and 157. I reviewed the FE analysis models and outputs at the meeting in September 2010 and was satisfied that I did not need to sample further.

564 Drawings in Section 1.2 of the EDCD indicate diagonal tie members, which tie the shield plate back to the ESB roof slope. I noted that these had been removed from the detail design. Ref. 157 Section 2.2.5 states that "*in order to avoid any shield plate swinging displacements due to independent modal shapes, and to minimize seismic amplification of the shield slab, the cross bracing between the vertical columns are installed.*"

Therefore, the bracing within the support structure was designed for the loads, such that diagonal ties were not required to provide stability.

565 Other pertinent details from Ref. 157 of the shield slab are as follows:

- The slab is formed by steel troughs suspended by the steel support structure. Concrete is then cast into these troughs. The central removable section also comprises a steel trough, which rests in a rebate around its perimeter again formed in steel. The central plug is bolted to the perimeter ring and the detail is designed to resist vertical movement.
- A mesh screen is supported by the shield plate structure *“in order to protect the upper containment annulus against external environmental particles.”*
- *“A non safety related drain for the shield plate is provided and routed out of the roof structure.”*
- *“In order to assure cleaning of the shield plate, dedicated lines of the Demineralized Water System will have to be routed up to the Shield Plate elevation.”*

566 Westinghouse and Ansaldo have also carried out a beyond design basis study to assess the effects of the shield plate support structure failing under extreme seismic or aircraft impact loads. The study assumed one side of the plate remained attached to the roof such that the free edge swung down and a plate corner impacted the top of the steel containment vessel. The damage to the CV and the resulting consequences were within the requirements of the beyond design basis safety case. This is detailed further in the separate HSE ND report for aircraft impact.

4.14.8.2 Findings

567 I am broadly satisfied that the design of the shield plate and its supports accounts for the design basis loadings, specifically SSE, such that the slab remains suspended and will not impact onto the CV top dome.

568 I am broadly satisfied that the holding down bolt detail for the central removable section should ensure it is held in place during design basis events.

4.15 Auxiliary Building

4.15.1 Introduction

569 The AP1000 Auxiliary Building submitted by Westinghouse is described in Section 3.3.5 of this report. The key parts of the civil structures are as follows:

- The common foundation with the Shield Building comprising a 1.8m thick, reinforced concrete raft.
- Reinforced concrete perimeter walls, which form the 12m deep basement and then rise up to roof level.
- Reinforced concrete internal walls, which segregate parts of the building from each other and provide lateral stability by acting as shear walls.
- Reinforced concrete roof slab.
- The SC module, CA20, which houses the spent fuel pond and adjacent ponds.

570 My assessment has focused on a number of areas. The two most significant ones are:

- the design methodology of the SC modules (i.e. CA20), which I consider to be outside the applicability of the code claimed. This is detailed in Section 4.16.6 of this report and has led to a GDA Issue, **GI-AP1000-CE-01**.
- the leak protection system for the spent fuel pond and adjacent ponds, which also has implications for CA20. This is detailed in Section 4.16.10 of this report and has led to a GDA Issue, **GI-AP1000-CE-04**.

571 My assessment also includes a detailed review of the load schedule application to the main part of the Auxiliary Building, which is included in this section. The detailed TSC work to inform this part of my assessment was undertaken by ABSC (Ref. 27). Deep samples of specific structural areas were also undertaken as listed below:

- Shear wall 7.3 - assessment of load combinations.
- Area 3 of the Auxiliary Building RC roof.
- Roof connection to the cylindrical Shield Building SC wall.
- West side wall of Spent Fuel Pond Area, CA20, between the spent fuel pond and fuel transfer canal.

572 The documents reviewed as part of my assessment are as follows:

- “Auxiliary Building Load Combinations and Loads for Finite Element Analysis”, APP-1200-S2C-003 Revision 0, August 2005 (Ref. 159)
- Significance of Wind and Tornado Loads on ASB. APP-1200-S2C-005 Revision 0. 19 July 2006 (Ref. 160)
- Auxiliary Building Wall 7.3 Dead Load, Live Load and Seismic Member Forces, APP-1200-S2C-102 (Ref. 161).
- Auxiliary Building Wall 7.3 Reinforcement Design APP-1200-CCC-102 (Ref. 162).
- ASB Fixed Base Static Analysis for Dead, Live and Seismic Loads. APP-1200-S2C-001 Revision 2. 3 August 2005 (Ref. 163)
- APP-1260-CCC-002 Revision 1, “Auxiliary Building Concrete Slab Design EL 160’-6” Areas 3&4” (Ref. 164).
- APP-GW-S1-009 Revision 0, Design Guide for Thermal Effects on Concrete Structures (Ref. 165).
- APP-1000-S3C-001 Revision 1, AP1000 Calculation of Nuclear Island Roof Snow Loads due to Snow Drift (Ref. 166)
- APP-CA20-CAC-011, Auxiliary Building - CA20 Wall Basic Design Calculation. Revision 1 (Ref. 167).

4.15.2 Load Schedule Application

4.15.2.1 Introduction

573 This assessment has confirmed that the detailed design of the RC structures of the Auxiliary Building has been performed to the requirements of ACI 349-01 (Ref. 22). There are some isolated areas of steel framing within the Auxiliary Building, predominantly steel floor beams (Ref. 159) which are designed to the requirements of AISC N690-94 (Ref. 96). Although both design codes are relevant and acceptable for seismic Category I structures, they are not the current revisions. Westinghouse has carried out an appraisal

of the differences between the codes used and the current revisions (Ref. 77). Refer to Section 4.3.2 of this report for my Assessment Findings on superseded codes.

574 The finite element (FE) models used for the design of the Auxiliary Building are the global models used for whole of the nuclear island, i.e. also including the Shield Building. The FE models are described in the EDCD (Ref. 67) and the ESB Design Report (Ref. 72). Detailed assessment of these is given in Section 4.9 of this report. Ref. 159 describes the loads and load combinations considered by Westinghouse in the detailed design analysis.

575 The eleven external hazards included in the load schedule (refer to Section 4.4.6) are clearly identified by Westinghouse as applicable to the civil design of the Auxiliary Building. However, three omissions were noted by ABSC (Ref. 27).

- Extreme temperature effect of solar gain not included.
- Drought not included by Westinghouse.
- Malicious activities considered by Westinghouse to be finally defined at site specific stage

576 Solar gain would affect the west wall of the Auxiliary Building and the cylindrical Shield Building. However, since the Auxiliary Building wall is reinforced concrete solar gain is not likely to be significant. Drought can affect the foundations on soil sites particularly where there are clay strata. It is therefore acceptable to be considered under site specific assessment (refer to Section 4.4.6). Westinghouse has addressed malicious activities within GDA and these are assessed under the security topic assessment report. Final site access and security arrangements will need to be revalidated against the generic design.

4.15.2.2 Loads from External hazards

577 Section 4.2 of the load combinations design report (Ref. 159) details the loads that Westinghouse considers in the design of the Auxiliary Building. This is mainly based on the Civil/Structural Design Criteria, APP-GW-C1-001 (Ref. 81). Eight further Westinghouse documents were sampled by ABSC in their review and details are given in Ref. 27.

578 Appraisal work documented in Significance of Wind and Tornado Loads on ASB (Ref. 160) gives the following conclusions in Section 2.2 on the wind and tornado load cases:

- *“The Auxiliary Building roof structures SHOULD BE evaluated for the tornado internal and external pressure loadings;*
- *“It is NOT NECESSARY to evaluate the Auxiliary Building external walls and roof for the wind loading;*
- *“It is NOT NECESSARY to evaluate the Auxiliary Building external walls for the tornado loads;*
- *“It is NOT NECESSARY to evaluate the Shield Building for the wind and tornado loads.”*

579 The reason given for this is that the seismic and accidental loadcase will govern. This is consistent with Section 2.2.1 of the ESB Design Report (Ref. 72), which states "*wind and*

tornado are not governing loads." This claim has been tested during the deep sample for wall 7.3 and found to be justified.

4.15.2.3 Loads from Internal Hazards

580 As stated in Section 4.5, the internal hazards barrier matrix needs further justification under GDA issues **GI-AP1000-IH-03, 04, 05** and **06** (Ref. 54 to Ref. 57). Therefore, the claims made by Westinghouse for civil structures, with respect to internal hazards loading, have not been assessed under this report.

4.15.2.4 Load Combinations

581 The main load combinations considered are from Table 3 of the Civil/Structural Design Criteria (Ref. 81) and are reproduced below in Table 18.

Table 18
Load Combinations for Auxiliary Building

LC	Load Combination
1	$U = 1.4D + 1.4F + 1.7L + 1.7H + 1.7Ro$
3	$U = 1.4D + 1.4F + 1.7L + 1.7H + 1.7Ro + 1.7W$
4	$U = D + F + L + H + Ro + To + Es$
5	$U = D + F + L + H + Ro + To + Wt$
6	$U = D + F + L + H + Ta + Ra + 1.4Pa$
7	$U = D + F + L + H + Ta + Ra + 1.25Pa + 1.0(Yr + Yj + Ym)$
8	$U = D + F + L + H + Ta + Ra + 1.0Pa + 1.0(Yr + Yj + Ym) + 1.0Es$
9	$U = 1.05D + 1.05F + 1.3L + 1.3H + 1.2To + 1.3Ro$
11	$U = 1.05D + 1.05F + 1.3L + 1.3H + 1.3W + 1.2To + 1.3Ro$

Where:

D = Dead Load

L = Live load

To = Normal Thermal load

W = wind

Es = SRSS of SSE loads

Ro = normal plant reactions

Ra = accident thermal reactions

Yj = jet impingement and thrust

F = hydro pressure

H = earth pressure at rest

Ta = accident thermal load

Wt = tornado

S = seismic sloshing

Pa = accident pressure

Yr = accident pipe reactions

Ym = pipe impact

582 These are generally consistent with the recommendations of ACI 349-01 (Ref. 22) although I note that load combinations and factors of ACI 349, are modified following the recommendations of the US NRC given in its Regulatory Guide 1.142 Revision 2 (Ref. 168) and document SECY-93-087 (Ref. 169). The latter recommends that the Operational Basis Earthquake (OBE) term is neglected, since it will be bounded by the SSE.

583 I conclude the loads are acceptable for the design of concrete structures which are seismic Class I.

4.15.3 Deep Sample of Wall 7.3

4.15.3.1 Introduction

584 This wall is an east-west shear wall and connects the external Auxiliary Building wall on the east elevation to the circular Shield Building wall. It is constructed of reinforced concrete and is 94ft high, being 3ft thick below ground level and 2ft thick above ground level.

4.15.3.2 Loads for Wall 7.3

585 For Wall 7.3, Section 4.5.2 of Ref. 161 defines the governing loads as:

- Dead Load.
- Live Load.
- Safe Shut Down Earthquake.
- Normal Thermal Load.

586 In Section 6 of Ref. 161, Westinghouse assesses the effect of wind, tornado and seismic loads on the individual external walls and roof of the Auxiliary Building. It is shown in all instances that external wind and tornado events are bounded by the governing seismic event and the accidental load cases. This justifies the claim made that it is not necessary to include wind and tornado loadcases (refer to paragraph 579).

587 Section 4.5.2(f) of Ref. 162 dismisses the “Liquid, Earth, Design Pressure, Normal Reaction, Accident Pressure, Accident Thermal, Accident Thermal Reactions, Accident Pipe Reactions, Jet Impingement and Pipe Impact loads” as being “*insignificant or irrelevant to the design of Wall 7.3*”. No detailed justification has been given but this is sought under GDA issues **GI-AP1000-IH-03 to 06**.

588 The wall perpendicular to Wall 7.3 is an earth retaining wall and thus wall 7.3 acts as a support. Therefore, in plane forces due to earth and ground water pressures will be induced in Wall 7.3. There will also be a significant surcharge loading from the Annex Building, which is founded directly alongside at just below ground level. This concern has been captured in **AF-AP1000-CE-43** (refer to Section 4.15.6), which affects all basement walls to the Auxiliary Building and those internal walls supporting them including Wall 7.3.

4.15.3.3 Load Combinations for Wall 7.3

589 The load combinations assessed are listed in Table 19 below:

Table 19

Load Combinations Applied to Wall 7.3

LC	Load Combination
1	1.4 D + 1.7 L
3a	D + L + Es

Table 19
Load Combinations Applied to Wall 7.3

LC	Load Combination
3b	D + L + E's
3c	0.9 D + Es
3d	0.9 D + E's
7a	1.05 D + 1.3 L + 1.2 ToN1-Summer
7b	1.05 D + 1.3 L + 1.2 ToN1-Winter

Where:

D = Dead Load

L = Live load

Es = SRSS of SSE loads

E's = Es with all member forces except axial forces (TX, TY) reversed to negative

To = Normal Thermal Load

590 It is noted that the load combinations considered by Westinghouse, do not consider the effect of reversing the SSE earthquake load; that is no consideration of compression load on the wall has been given. It is not readily apparent in the reviewed documentation that compression was considered. This is captured in **AF-AP1000-CE-44** in Section 4.15.6.

4.15.3.4 Methodology of Wall 7.3 Deep Sample

591 In order to test the design methodology, ABSC reviewed Ref. 161 and Ref. 162 in detail. Element forces from the FE analyses are summarised in Ref. 161 and then combined in Ref. 162. Both documents use source data from APP-1200-S2C-001 Revision 2, *ASB Fixed Base Static Analysis for Dead, Live and Seismic Loads* (Ref. 163).

592 ABSC selected one element from the FE Analysis model and manually combined the calculated loads from Ref. 161 to check agreement with the Westinghouse combination in Ref. 162. This was carried out for Load Combination 3a in Table 19 above, and the combination was verified.

593 The FE models presented in Ref. 161 and Ref. 162 should be the same; however ABSC notes there are discrepancies in the element mesh and numbering (Ref. 27). The reason for the inconsistency in meshing is believed to stem from refinements performed to the NI-05 model between the publication dates of the two reports, 2002 and 2008 respectively. Since the calculation design check performed by ABSC has demonstrated the load demand is not significantly affected by the modelling discrepancy, I am broadly satisfied that the methodology has been applied correctly.

4.15.4 Deep Sample of Auxiliary Building Roof

4.15.4.1 Introduction

594 A deep sample assessment of the design of reinforced concrete slab to roof area 3 was undertaken (Ref. 27).

595 Figure 11 below shows the location of Area 3. The roof slab comprises 380 mm (15 inch) thick reinforced concrete poured on top of a 114mm (4.5 inch) thick metal deck and is located at elevation 118.4m (160'-6").

596 The reason this part of the roof was selected for deep review is that there is the potential for snow to drift against the wall of the Shield Building. The Technical Assessment Guide 13 (Ref. 13) which recommends that "snow loading should be at least as onerous as given in BS6399-3: 1998, taking account of drifting effects where this can occur." It was not clear from the high level review of external hazards and the EDCD whether drifting snow had been considered in the AP1000 design.

4.15.4.2 Loads for Auxiliary Roof, Area 3

597 No particular individual load is considered as governing, but from Section 4.3.3 of Ref. 164 the load cases assessed in combination are:

- Dead Load.
- Live Load (which includes snow loading).
- Safe Shut Down Earthquake (SSE).
- Normal Thermal Load.

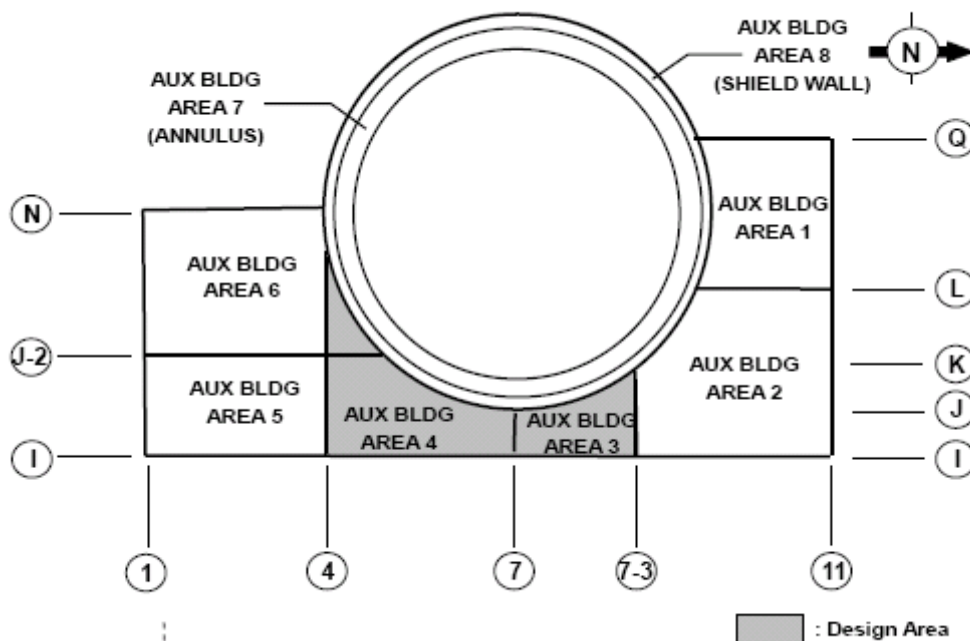

Figure 11: Areas 3&4 at Elevation 160'-6" (Figure 1-1 of APP-1260-CCC-002)

598 The combination of thermal load and SSE load are not considered, based on the findings of the *Design Guide for Thermal Effects on Concrete Structures* (Ref. 165). Section 3.2 of this reference states that "the thermal effects will be self-relieving when the structure is subjected to an extreme or accident event. Such events are:

- 1) Pipe Whip.

- 2) *Pipe Break.*
- 3) *Safe-Shutdown-Earthquake (SSE).*
- 4) *Impact.*
- 5) *Jet impingement”.*

599 The commentary for Section 9 of ACI 349 (Ref. 22) recognises that thermal stresses can be self-relieved when subjected to an event that causes cracking, deformation, and/or yielding to occur. However, Section 3.2 of Ref. 165 also provides the following caveat “*this does not relieve the designer’s responsibility to identify potential design problems as shown ... induced by restraint of thermal growth.*”

600 I accept this approach is reasonable, provided the caveat above is adhered to.

601 The accident pressure load is dismissed in Section 4.5.2.6 of Ref. 161, which states “*The accident pressure load (Pa) is generated by the postulated pipe break. The beams of the design areas in this calculation are not subjected to any accident pressure load.*” This statement implies that there are no pipes in the vicinity of this area of roof that could cause significant loading if they ruptured. The Internal Hazards assessment (ONR-GDA-AR-11-001, Ref. 35) has raised queries with respect to the barrier matrix as stated above in Section 4.5.

4.15.4.3 Snow Drift Load

602 The wind driven drifting of snow across the Auxiliary Building roof against the Shield Building wall should be accounted for in the application of the Live Load. The document AP1000 Calculation of Nuclear Island Roof Snow Loads due to Snow Drift (Ref. 166) was sampled for evidence that this had been carried out correctly (Ref. 27). This was carried out for roof areas 3 and 4 as before.

603 The assessment confirmed that the maximum snow drift surcharge for areas 3 and 4 had been calculated in accordance with ASCE 7-98 (Ref. 91). This was shown as 2.25kN/m² (47.1 psf) in Table 5-1 of Ref. 166. The live load applied to the Auxiliary Building roof in this calculation included the uniform snow load and drift surcharge load to give a total live load of 5.32kN/m² (111psf).

4.15.5 Deep Sample of CA20 within Auxiliary Building

4.15.5.1 Introduction

604 The detailed assessment of the structural design of this module is given in Section 4.16.7 of this report. This section concentrates on the external and internal hazards load application to the design of the structure.

605 Two documents were supplied by Westinghouse, APP-CA20-CAC-011 Revision 1 (Ref. 167) and APP-1200-CCC-010 Revision A (Ref. 170). Both are titled, *Auxiliary Building – CA20 Wall Basic Design Calculation* and are essentially the same document. Therefore, my assessment has used APP-CA20-CAC-011 Revision 1 since it is more recent than the other document and is formally approved.

4.15.5.2 Loads and Load Combinations

606 There is no mention on loads relating specifically to CA20 or of which loads are governing. Therefore, it has been assumed that the general loads as given in “*Auxiliary*

Building Load Combinations and Loads for Finite Element Analysis", APP-1200-S2C-003 (Ref. 159) are used.

607 There is also no mention of any loads being dismissed because they are bounded by other loads.

608 Section 3.2.3 of *CA20 Wall Basic Design Calculation* (Ref. 167) defines the following loads to be applied to the CA20 module:

- Dead Load.
- Live Load.
- Liquid Load.
- SSE Load.
- Normal and Accident Thermal Load.

609 Twenty three load combinations are defined and are repeated as Table 20. These are all based on the load combinations in ACI 349-01.

1a.	$1.4 D + 1.7 L + 1.4 F$		[1]
3a.	$D + L + \beta F + Es$		[2]
3b.	$D + L + \beta F + E's$		[3]
3c.	$D + L + \beta F' - Es$		[4]
3d.	$D + L + \beta F' - E's$		[5]
3e.	$D + L + \beta F + Es$	$+ \alpha To (N1)$	[6]
3f.	$D + L + \beta F + E's$	$+ \alpha To (N1)$	[7]
3g.	$D + L + \beta F + Es$	$+ \alpha To (N2)$	[8]
3h.	$D + L + \beta F + E's$	$+ \alpha To (N2)$	[9]
3i.	$D + L + \beta F' - Es$	$+ \alpha To (N1)$	[10]
3j.	$D + L + \beta F' - E's$	$+ \alpha To (N1)$	[11]
3k.	$D + L + \beta F' - Es$	$+ \alpha To (N2)$	[12]
3l.	$D + L + \beta F' - E's$	$+ \alpha To (N2)$	[13]
3m.	$0.9D + \beta F + Es$		[14]
3n.	$0.9D + \beta F + E's$		[15]
3o.	$0.9D + \beta F + Es$	$+ \alpha To (N1)$	[16]
3p.	$0.9D + \beta F + E's$	$+ \alpha To (N1)$	[17]
3q.	$0.9D + \beta F + Es$	$+ \alpha To (N2)$	[18]
3r.	$0.9D + \beta F + E's$	$+ \alpha To (N2)$	[19]
5a.	$D + L + F$	$+ \alpha Ta (A1)$	[20]
5b.	$D + L + F$	$+ \alpha Ta (A2)$	[21]
7a.	$1.05 D + 1.3 L + 1.05 F + 1.2 \alpha To (N1)$		[22]
7b.	$1.05 D + 1.3 L + 1.05 F + 1.2 \alpha To (N2)$		[23]

where, D Dead load (Section 3.2.3.1)
 L Live load (Section 3.2.3.1)
 F Liquid load with each member force taken to be critical in tension (maximum for axial and absolute-value-max. for others) among $F1$ through $F4$ (Section 3.2.3.2)
 F' Liquid load with each member force taken to be critical in compression (minimum for axial and absolute-value-max. for others) among $F1$ through $F4$ (Section 3.2.3.2)
 β Liquid load increase factor due to vertical SSE (Section 3.2.3.2) $\beta = 1.4$
 Es SRSS (i.e. all member forces are positive) of the SSE loads (Section 3.2.3.3)
 $E's$ Es with all member forces except axial forces (TX, TY) reversed to negative
 αTo Reduced normal thermal load (Section 3.2.3.4) $\alpha = 0.625$ (Figure 3-2)
 αTa Reduced accident thermal load (Section 3.2.3.4) $\alpha = 0.625$ (Figure 3-2)

Table 20: Load Combinations for CA20 Modules**4.15.5.3 Deep Sample of Load Combination 03**

- 610 This deep sample considers the methodology applied to combine the individual load case results to calculate results for the load combinations, in Table 20, for concrete structures. The example load combination sampled by ABSC was LC03 (Ref. 27).
- 611 Section B1.1 of Ref. 145 details the methodology and lists the ANSYS input load cases and the postprocessor combinations. The figures for LC03 were followed through this document and it was concluded that the methodology was correct and had been applied correctly.

4.15.6 Summary and Findings

612 I conclude that the appropriate external hazards have been included in the design of the Auxiliary Building, with the exceptions of those considered to be site specific which are raised as findings in Section 4.4.6.

613 The internal hazard barrier matrix needs to be further justified under GDA Issues **GI-AP1000-IH-03, 04, 05 and 06** (Ref. 54 to Ref. 57). This may affect the loads applied to civil structures resulting from internal hazards.

614 I am broadly satisfied that the methodology has been applied correctly to the design of wall 7.3. However, I have the following two Assessment Findings.

615 The deep sample of wall 7.3 has highlighted that all the basement walls to the Auxiliary Building will need to be verified at site specific stage for lateral earth pressures and surcharge loading from adjacent buildings. This is captured in the Assessment Finding below which must be addressed prior to milestone 2 – first concrete.

***AF-AP1000-CE-43:** All the basement walls to the Auxiliary Building will need to be verified at site specific stage for lateral earth pressures and surcharge loading from adjacent buildings. The licensee shall justify that the site specific earth pressures are bounded by the generic design of the Auxiliary Building basement structures. Where this is not the case, the licensee shall revise the design accordingly.*

616 The deep sample of wall 7.3 has highlighted that no substantiation has been given on the effect of reversing the SSE earthquake load; i.e. compression load on the wall. This will need to be justified following the site specific seismic analysis. This is captured in the following Assessment Finding which must be addressed prior to milestone 2 – first concrete.

***AF-AP1000-CE-44:** The licensee shall justify that for the site specific seismic analysis, the compression load on the walls of the auxiliary basement from reversal of the SSE are bounded by the generic design. Where this is not the case, the licensee shall revise the design accordingly.*

617 Thermal loads on the roof have not been considered in combination with extreme or accident events, based on ACI 349 recognition that thermal stresses can be self relieved when subject to such an event. Since the Auxiliary Building roof is a RC structure, ACI 349 is an applicable code and thus I consider this approach as reasonable.

618 I conclude that Westinghouse has considered the effect of snow drifting, as recommended by TAG T/AST/013 (Ref. 13), on the section of Auxiliary Building roof examined for the deep sample, i.e. that adjacent to the Shield Building wall where drifting could occur.

4.16 SC Modular Construction

4.16.1 Introduction

619 The AP1000 civil design includes the use of steel-concrete composite construction for the following Category I structures:

- 1) The part of the Enhanced Shield Building (ESB) cylindrical wall that is not protected by the Auxiliary Building.
 - 2) The conical roof to the Shield Building (refer to Section 4.14.4).
-

- 3) The containment internal structures (CIS).
- 4) The Spent Fuel Pool (SFP) cell structure in the Auxiliary Building.
- 5) Floors within the Auxiliary Building.

620 In composite structures concrete is poured on, against or between steel plates. The steel and concrete are designed to act compositely with each other. Westinghouse's intention is to pre-fabricate the steel part of the various structures into modules, lift into final position and then fill with concrete.

621 The design of certain composite steel and concrete structures is conventional within civil engineering and is covered by established codes. However, Westinghouse has adopted a novel form of steel-concrete-steel sandwich module for the ESB wall and the modules forming the CIS and the SFP structures (collectively known as CA Modules). The key design principle that Westinghouse has made is that these structures can be designed to the reinforced concrete code, Code Requirements for Nuclear Safety Related Concrete Structures, ACI 349-01 (Ref. 22).

622 This section of my report describes my assessment of the design submitted by Westinghouse for the above composite structures. However, more emphasis is given to the novel steel-concrete composite walls and floors (here after referred to as SC construction) rather than those that can be designed to established codes.

623 Modular construction of this form, when applied to nuclear power plants, is a proprietary Westinghouse design and has not, to date, been used in any European or US power plant construction. However, there are similar AP1000 plants which are at an early stage of construction in China. The US NRC has reviewed the generic designs of both the CA Modules and the ESB but has not, so far, licensed any site specific plants in the USA.

624 Although I have liaised with the US NRC during their assessment work for the ESB, my assessment is wholly independent and is based on the UK regulatory expectations.

4.16.2 Assessment Progress

625 The HSE ND Step 3 Report on Civil Engineering and External Hazards Assessment of the Westinghouse AP1000, (Ref. 20) contained a number of reservations as to the use of the SC modular construction method, mainly due to the lack of an established design code specific to this form of construction. In particular, the Westinghouse claim that ACI-349-01 was the appropriate design standard, was found not to be fully justified. On the basis of the information available, it appeared that the ACI 349-01 code was being used outside its scope of applicability, which gave rise to technical concerns with respect to the treatment of in plane shear, out-of-plane shear and the effect of thermal loads on the composite section. Step 3 assessment of the design was also hampered by the late issue of significant Westinghouse documents concerning the modular design methodology and the design of the ESB, which were received too late to be properly considered at that time.

626 In Step 3, TQ-AP1000-69 was raised stating that it was not apparent that ACI 349-01 was applicable to the modular steel/concrete sandwich form used in AP1000. For example, Clause 1.1.7.2 excludes structural concrete slabs cast on stay-in-place composite steel form deck, which appears to be the structural system described in ACI 349-01 closest to the steel/concrete sandwich form used on AP1000. As some references concerning the design methodology were not forthcoming, the question was transferred to TQ-AP1000-

143. When no suitable response was forthcoming, this was raised to a Regulatory Observation as RO-AP1000-041.

627 In February 2010, as part of the Step 4 assessment, HSE ND further raised the status of the question to a Regulatory Issue RI-AP1000-02 for resolution. This RI referred to the SAPs below and the supporting paragraphs 176 and 177.

Engineering principles: safety classification and standards	Use of experience, tests or analysis	ECS.5
In the absence of applicable or relevant codes and standards, the results of experience, tests, analysis, or a combination thereof, should be applied to demonstrate that the item will perform its safety function(s) to a level commensurate with its classification.		

Engineering principles: reliability claims	Form of claims	ERL.1
The reliability claimed for any structure, system or component important to safety should take into account its novelty, the experience relevant to its proposed environment, and the uncertainties in operating and fault conditions, physical data and design methods.		

“176 Adequate reliability and availability should be demonstrated by suitable analysis and data.

177 Where reliability data is unavailable, the demonstration should be based on a case-by-case analysis and include:

- a) a comprehensive examination of all the relevant scientific and technical issues;*
- b) a review of precedents set under comparable circumstances in the past;*
- c) an independent third-party assessment in addition to the normal checks and conventional design;*
- d) periodic review of further developments in technical information, precedent and best practice.”*

628 Three actions were assigned to RI-AP1000-02 as follows:

- A1 Westinghouse is required to both complete and, if necessary, revise its document Design Methodology for Structural Modules APP-GW-SUP-001 Revision 0, dated 2003.
- A2 Westinghouse is required to demonstrate the adequacy of its specified design methodology revised, if necessary, following structural testing for structural modules.
- A3 Westinghouse is required to review the implications of changes to its design methodology for CA structural modules, such as revealed for the Enhanced Shield Building at a meeting with US NRC (also attended by ONR) on 17 November 2009. Westinghouse should ensure that the review considers implications of the changes for other nuclear structures, or parts of structures, having a similar form of construction and similar nuclear safety classification (UK classifications). The implications should similarly be considered for all nuclear safety structures, or parts of structures similarly constructed, taking due regard of any lesser or greater nuclear safety classification.

- 629 This RI was mainly aimed at the design methodology for the CA Modules. However, regulatory expectations for Action A3 were that the revised design proposals for the ESB, presented to US NRC on 17 November 2009, should be formally submitted to ONR.
- 630 Additional guidance on the response expected to RI AP1000-02 above was given in May 2010 via Regulatory Observation RO-AP1000-079. This stated that it should include, but not necessarily be limited to, the matters raised in the associated actions as follows:
- A1 Description and analysis of potential failure modes.
 - A2 A consistent and coherent description of the mechanical system, components and load paths in relation to the claimed analogy of reinforced concrete (RC) design, including an explanation of the various roles of each component.
 - A3 Design and construction of joints between units and between units and RC construction.
 - A4 Details of the structural analysis approach demonstrating how;
 - Global analysis model using SHELL elements with smeared properties accounts for the composite panel including the effects of creep, shrinkage, cracking and load transfer between the composite components.
 - Whether a more detailed model of a local area is to be used to validate the use of the SHELL elements.
 - A5 How the thermal analysis models capture thermal effects, such as environmentally induced transients.
 - A6 Details of construction load cases and how built-in stresses induced by all temporary construction load cases are accounted for in the normal operating, fault and extreme load combinations.
 - A7 Justification for the proposed use of self-compacting concrete (SCC) which is considered to be novel, particularly in the context of a nuclear environment and steel plate-concrete composite (SC) modular construction. In particular, the justification should demonstrate any effect on the behaviour of shear studs.
 - A8 Demonstration that the long-term reliability of the SC system is equivalent to that achieved by mature and established design Codes for traditional steel and concrete structures.
- 631 With the aim of addressing the technical content of RI-AP1000-02 and its amplification in RO-AP1000-079, Westinghouse has provided additional design justification and reports at Step 4 in support of the SC modular designs for the ESB and the CA Modules. Several technical queries have been raised to obtain further evidence or clarification. The most notable are TQ-AP1000-1085 on the ESB and TQ-AP1000-1091 on the CA Modules.
- 632 The documentation obtained has been assessed by HSE ND with the aid of specialist civil engineering technical support consultants, Amec and Arup, and has been the subject of several technical meeting with Westinghouse to ensure a clear understanding of their design intentions.
-

4.16.3 Documents Submitted

633 In response to RI-AP1000-002 and RO-AP1000-079, Westinghouse has submitted a significant body of work in order to demonstrate that its ACI 349-01 based calculations provided reasonable estimates of concrete and steel plate thickness. A summary of the submission timeline is presented in Table 21 below.

Table 21

Assessment Timeline for SC Construction Assessment

Date	Item	Description
September 2009	ESB Report	APP-1200-S3R-003, Revision 0, Design Report for the AP1000 Enhanced Shield Building (Ref. 69).
September 2009		APP-GW-SUP-001 Revision 0, Design Methodology for Structural Modules (Ref. 172)
16 February 2010	RI-AP1000-002	Regulatory Issue raised, with three actions.
February 2010		Response to RI-AP1000-002.A1. APP-GW-SUP-001 Revision 1 (Ref. 86), Design Methodology for Structural Modules.
March 2010	ESB Report	APP-1200-S3R-003, Revision 1, Design Report for the AP1000 Enhanced Shield Building (Ref. 70).
May 2010	RO-AP1000-079	Regulatory Observation with eight actions.
May 2010	ESB Report	APP-1200-S3R-003, Revision 2, Design Report for the AP1000 Enhanced Shield Building (Ref. 71).
June 2010	US NRC Technical Meeting	ND attended this technical meeting on the ESB.
30 June 2010	Letter WEC 000254	Partial response to RI-AP1000-002.A2 plus plan for remainder (Ref. 171).
16 Aug 2010	Letter WEC 000295	CA Modules Design Report APP-1000-S3R-002 Revision A (Ref. 143).
19 Aug 2010	Letter WEC 000298	Clarification that APP-1000-S3R-002 Revision A was partial response to RO-AP1000-79 Actions A1, A2, A4, and A6 (Ref. 173)
25 Aug 2010	ND Technical Meeting	Meeting held with Westinghouse in Preston to discuss SC design methodology.
15 Sept 2010	ND Technical Meeting	Meeting held with Westinghouse in Pittsburgh to discuss SC design methodology.
30 Sept 2010	Letter WEC 000367 Letter WEC 000369 Letter WEC 000370	Partial response to RO-AP1000-079.A3 (Ref. 174) Partial response to RO-AP1000-079.A2 (Ref. 175) Partial response to RO-AP1000-079.A7 (Ref. 125)
Oct 2010	ESB Report	APP-1200-S3R-003, Rev.3, Design Report for the AP1000 Enhanced Shield Building (Ref. 72).

Table 21

Assessment Timeline for SC Construction Assessment

Date	Item	Description
29 Oct 2010	Letter WEC000403	UKP-GW-GLR-018 Revision A (Ref. 73), Westinghouse Response to RI-002 and RO-AP1000-079 APP-GW-SUP-001 Revision 2 (Ref. 86), Design Methodology for Structural Modules.
29 Oct 2010	Letter WEC000405	List of 22 supporting documents to UKP-GW-GLR-018 (Ref. 176)
30 Nov/ 1 Dec 2010	ND Level 3 Technical Meeting	Meeting held with Westinghouse in Pittsburgh to discuss SC design methodology.
23 Dec 2010	Letter WEC000457	8 pages of technical information in response to meeting of 30 November 2010 (Ref. 177)
30 Dec 2010	Letter WEC000466	5 pages of technical information in response to meeting of 30 November 2010 (Ref. 178)
9 Jan 2011	Letter WEC000469	71 pages of technical information in response to meeting of 30 November 2010, plus 9 technical documents submitted (Ref. 134)
18 Jan 2011	Letter WEC000481	Submittal of APP-CA20-S3C-002 Revision 4, CA20 Connection Design: Module Wall to Basemat (Ref. 179) APP-1000-T2R-027 Revision 0, Module Test Program Summary (Ref. 180)
26 Jan 2011	Letter WEC000489	3 pages of technical information in response to Action 4.1 from meeting of 30 November 2010 (Ref. 181)
7 Feb 2011	Letter WEC000498	2 pages of technical information in response to Action 12.1 from meeting of 30 November 2010 (Ref. 182)
1 March 2011	Letter WEC000523	Submittal of APP-1000-T2R-027 Revision 1, Module Test Program Summary (Ref. 183)
March 2011		Submittal of APP-1100-S3C-017 Revision A (Ref. 153).

634 In addition to the above, more information was received in the form of detailed calculations, drawings and technical letters. These are referenced as appropriate in my report.

4.16.4 Structural Arrangement of SC Walls

635 The form of construction for SC walls is to use a bespoke system; steel plates on each face of the concrete wall, forming a sandwich, tied together by an arrangement of steel tie bars or channel trusses with an unreinforced concrete infill. The steel plates are intended to serve the same function as reinforcing steel in standard reinforced concrete. The composite action of the steel plates with the concrete is facilitated by a combination of shear studs and the cross ties.

636 The basic physical arrangement of the CA Modules is different to that of the ESB SC wall. Figure 12 and Figure 13 compare the typical arrangement for each.

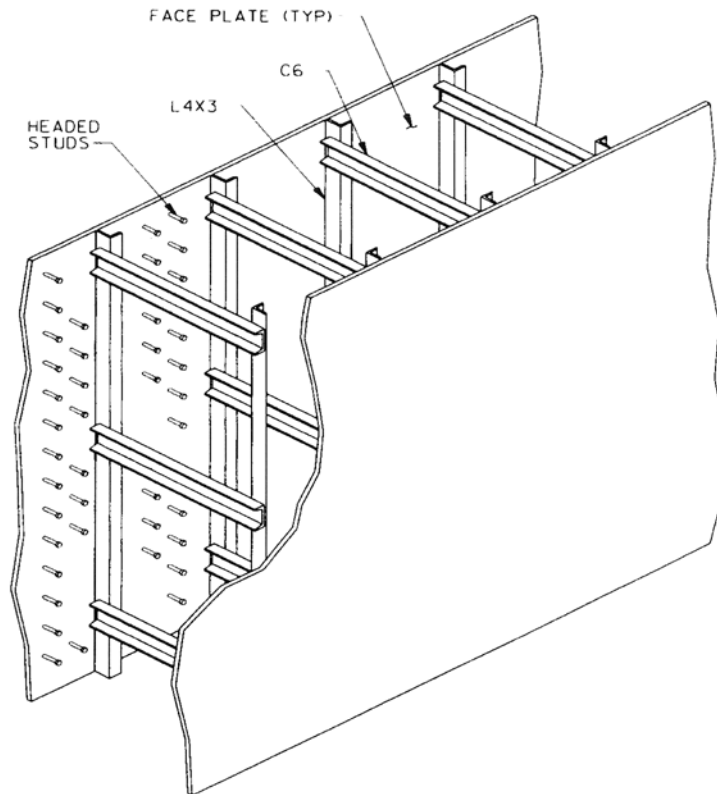

Figure 12: Arrangement of Steel Plates, Shear Studs and Steel Trusses for CA Modules

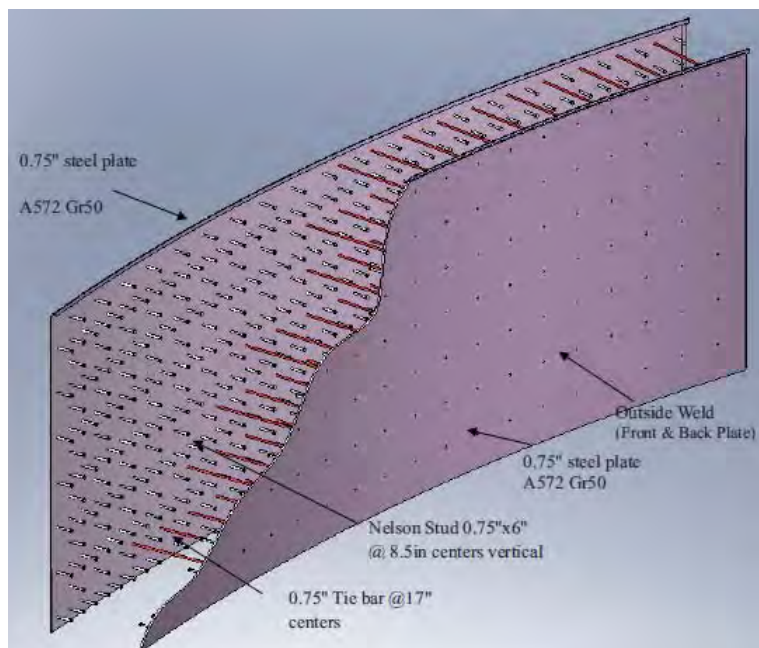

Figure 13: Arrangement of Steel Plates, Tie Bars and Shear Studs for ESB

- 637 The SC walls are prefabricated and lifted into final position, before being filled with concrete. Westinghouse proposes that the main benefits of this form of modular construction are:
- Design – the steel plates are considered as reinforcing steel and hence no conventional reinforcement is provided.
 - Design – the steel plates will make the ESB more resilient to impact loads than the original reinforced concrete design (AP600).
 - Quality - the pre-fabrication is carried out in the controlled environment of a fabrication shop, both off and on-site, and so quality is more inherent.
 - Commercial - the steel plates form permanent formwork for the concreting.
 - Commercial – overall there should be a considerable reduction in the build time, and hence cost, for the main civil structures.
- 638 The CA wall modules consist of two steel plates connected together by steel Vierendeel trusses. The overall width of the wall ranges from 457mm to 1370mm (18" to 54"), although it is 762mm typically (30"). The typical plate thickness is 12.7mm (0.5") although this is increased to 25.4mm and 38.1mm in places (1" and 1.5"). The trusses comprise vertical angle sections with horizontal channel sections. Shear studs are welded to the inside of the steel plates and are provided at 254mm (10") spacing vertically and horizontally¹. The angles rise the full height of the module and are continuously welded to the back of the plates. They are spaced typically at 762mm (30") horizontally and so replace every third column of studs. The channels are spaced typically at 1219mm vertically (48").
- 639 The trusses allow the modules to be handled as temporary structures but become part of the permanent structure after concrete filling. The angles act as plate stiffeners during fabrication of sub-modules, which is carried out in an off-site fabrication yard. The sub-modules are designed to be transported on Amtrak rail gauge as 24m by 3m by 3m modules (80ft by 10ft by 10ft). At the site, the sub-modules are joined together to form massive modules in the on-site fabrication yard. These modules are then lifted into final position by heavy lift crane.
- 640 The ESB SC wall has an overall thickness of 914mm (36"), which is the same as the RC wall below it. The standard wall panel has an arc length of approximately 11.5m (30 degrees) and is 3m in height (Section 3.1 of Ref. 72). Tie bars are welded between the plates to form the module and these act as shear connectors in combination with nelson shear studs. The wall panel comprises:
- 19mm (0.75") steel plates on each face (ASTM A572 Grade 50 steel).
 - Standard concrete with $f'c = 41.6 \text{ N/mm}^2$ (6000psi).
 - 19mm nelson shear studs welded to the inside face of both plates spaced at 213mm horizontally (0.5625 degrees around the circumference) and 216mm vertically. One stud in every four is replaced by a 19mm diameter tie bar such that the ties are provided at 425mm horizontally and 432mm vertically (this arrangement is shown in figure 2).

¹ The exact spacing of studs is being developed by Westinghouse at the time of writing ONR-GDA-AR-11-002. Therefore, the 10" stud spacing may change.

- In the higher stress regions all studs are replaced by tie bars, which are spaced at 152mm nominal centres.

641 The two plates are prefabricated into two concentric rings in 10m high sections. The plates are held together by the tie bars. On site, each one is then lifted using a lifting frame and positioned on top of the preceding section and the plates welded together. Once all rings are erected, the annulus is filled with concrete.

4.16.5 Structural Arrangement of SC Floors/Slabs

642 There are four main types of composite floors/slabs which are used in different locations. There are no floors within the ESB. Although the conical roof is constructed using a steel plate on the underside, the slab is designed as reinforced concrete and so is not composite (refer to Section 4.14.4).

643 The structural arrangement and design principles of SC floors are summarised below.

AISC N690 Composite Floors

644 These are used in the CIS modules. A bespoke design is used comprising concrete cast onto a bottom steel plate with embedded steel shapes, including shear studs and T sections that are designed according to AISC N690-94 (Ref. 96) provisions for composite floors. The steel plate provides the bottom reinforcement, and the top rebar in the concrete provides the top reinforcement. These slabs may be supported on top of the primary steel beams, or the steel beams may be embedded into the slabs.

ACI 349 HSC (Half-Steel-Concrete) Floors

645 These floors are used in the SFP module. A bespoke design is used which comprises half of a CA module composite wall using the same methodology based on ACI 349-01 (Ref. 22). With the primary load carrying members being the bottom steel plate and top reinforcing bars, there are also embedded steel shapes that are designed to stiffen the bottom steel plate during concrete placement (Letter WEC000469, Ref. 134).

Concrete Finned Floors

646 These are used in the main control room and instrument rooms and are basically a subset of HSC floors. These are also designed as reinforced concrete slabs in accordance with ACI 349. However, the steel plate has fin stiffeners welded to the underside of the plate, which project downwards. This is to aid cooling of those rooms. The fins and plate serves the function of bottom reinforcement for positive bending. Top rebar is provided in the slab for negative bending. The fins are exposed to the environment of the room and enhance the heat-absorbing capacity of the ceiling. Shear studs are welded on the top side of the steel plate, and the steel and concrete act as a composite section (3H5.4 of EDCD)

Q-Deck floors

647 This is a US term for proprietary metal decking. These floors are conventional steel/concrete composite floors and comprise concrete slab cast on proprietary metal decking spanning onto composite steel beams with shear studs. The beams and reinforced concrete slab are designed to be composite floors according to AISC N690 provisions (Letter WEC000469, Ref. 134).

4.16.6 Design Methodology for SC Structures

4.16.6.1 Background

648 The original AP600 design methodology of the modules is reported in GW-SUP-003, Report on structural analysis methodology for steel-concrete panels with welded shear studs (Ref. 184). This is referenced in the most recent major submission, AP1000 Westinghouse Response to RI-AP1000-02 and RO-AP1000-079, UKP-GW-GLR-018 (Ref. 73) as relevant work conducted by Westinghouse that provides early AP600 technical justification for the design of SC modules. This document provides information on the effect of IRWST heat up on concrete stiffness and shear stud deformation.

649 Other conclusions and recommendations given in GW-SUP-003 (Ref. 184) are:

- *“The ultimate flexure capacity of the sandwich composites can be calculated by conventional formula for reinforced concrete.”*
- *“The current ACI design procedures for members in combined shear and tension are excessively conservative.” “It is recommended to use the American Association of State Highway and Transportation Officials (AASHTO) Bridge Design Specification.”*

4.16.6.2 CA Modules

650 The design methodology used by Westinghouse for the CA Modules is contained within *Design Methodology for Structural Modules*, APP-GW-SUP-001 Revision 2 (Ref. 86). Its leading reference is the *AP1000 Civil/Structural Design Criteria*, APP-GW-C1-001 Revision 1 (Ref. 81).

651 The first issue of APP-GW-SUP-001 (Ref. 172) was received in September 2009 during Step 3. This revision was dated 17 February 2003 and appeared to be incomplete, which thus prompted RI-AP1000-002 to be raised. Revision 1 (Ref. 85) was submitted in response to Action A1 of the RI in February 2010 but, following the issues raised as part of the Step 4 assessment and design feedback from the plant under construction in China, a further revision APP-GW-SUP-001 Revision 2 (Ref. 86) was submitted in October 2010 in response to Actions A2 and A3. Each revision has been fully reviewed during the Step 4 assessment, along with full or partial reviews of the myriad supporting documents.

652 The methodology covers materials, loads, analyses, design of form modules, design of structural wall modules, design of structural floor modules, thermal considerations and evaluation for thermal loads.

653 The key premise of the methodology is that SC structures can be designed conservatively as reinforced concrete structures to the provisions of ACI 349-01. The required area of reinforcement is calculated for vertical and horizontal directions and compared with the plate thickness provided. The methodology also includes the design of form modules and wall modules without concrete fill. It is stated that these are to be designed as steel structures to AISC N690 1994 and since this is an established code, these are not discussed further in this section.

4.16.6.3 ESB SC Wall

654 The design methodology used by Westinghouse for the ESB wall is contained within the *Design report for the AP1000 Enhanced Shield Building, APP-1200-S3R-003 Revision 3* (Ref. 72). Section 2.2 of Ref. 73 describes the design process as follows:

655 [Redacted]

656 [Redacted]

657 Therefore, the ESB SC wall design essentially claims to use the same analogy with RC construction as claimed for the CA Modules.

4.16.6.4 Benchmark Testing

658 In the ESB Design Report (Section 2.4 of Ref. 72) Westinghouse describes that, in order to confirm the AP1000 methodology of using the ACI 349 code provisions for SC design, a combination of testing and benchmarked analysis was used. The testing considered comprises:

- Historical tests performed in Japan for the development of the Japanese design code, Technical Guidelines for Aseismic Design of Steel Plate Reinforced Concrete Structures – Building and Structures JEAG 4618-2005. Japan Electric Association Nuclear Standards Committee (Ref. 185).
- A test programme carried out by Purdue University on behalf of Westinghouse specifically for the ESB (Ref. 72)

659 [Redacted]

- [Redacted]
- [Redacted]
- [Redacted]
- [Redacted]

660

661

662

663

Since the Westinghouse testing was specifically of the ESB structure, a further set of testing for the CA Modules was undertaken in autumn 2010. At the time of writing this report the final test reports had just been received although initial indications are that this testing yielded confirmatory results. GDA Issue **GI-AP1000-CE-01** (Ref. 63) includes submission of these test results and justification of how these supplement the evidence on the capabilities of the CA Module composite design.

4.16.7 Assessment of CA Modules

4.16.7.1 Design Provisions

4.16.7.1.1 Assessment

664

My assessment has focused on the loads applied to the CA Modules and Westinghouse's justification of how the system, including its individual components, resists these loads. The current design methodology does not include a review of the structural mechanics of the system, or of secondary effects outside of the main FE analysis.

665

The effects of simultaneous loading and structural actions need to be quantified. The following loading actions have been considered by Westinghouse.

- Construction
 - fabrication stresses;
 - erection loads during lifting operations;
 - concrete placement loads.
- Design loads
 - axial tension and compression;
 - out-of-plane moment;
 - out-of-plane shear;
 - in-plane shear;
 - thermal.

666

These are discussed in more detail below.

Fabrication and Erection Stresses

667

The loads resulting from erection are checked in document APP-1000-SUC-006 (Ref. 186). The effects of locked in stresses from fabrication and from lifting the completed

module into position, have not been considered as additional to the stresses calculated from in-service design loads. I have raised **AF-AP1000-CE-45** to ensure this is justified just prior to construction (refer to Section 4.16.7.1.2 for findings on design).

Concrete Placement Stresses

668 The concrete to be used is self consolidating concrete (SCC). Action A7 of RO-AP1000-079 requested justification for the use of SSC and whether there was any detrimental effect on the design assumptions. Westinghouse's response was given in their letter of UN REG WEC 000370 of 30 September 2010 (Ref. 125). The responses to the two questions on wet concrete effects, namely concrete pressure and induced stresses in the plate, are discussed below.

669 Section 4.1.6 of the methodology (Ref. 86) states that "*the face plates and the trusses of the wall structural modules shall be designed to support a concrete placement pressure of 1050 lbs per square foot. The pressure is based on Table 5-4 of Reference 2.4 for a maximum concrete lift height of 7 feet or at a placement rate equal to or less than 6 feet per hour at 60°F Fahrenheit.*" Reference 2.4 is American Concrete Institute (ACI) "Formwork for Concrete" ACI SP-4, 4th Edition (Ref. 187). This placement pressure value was queried via TQ-AP1000-665 on 25 May 2010 since it is based on normal weight concrete. Both the European Guidelines for Self Compacting Concrete (Ref. 188) and the UK Concrete Centre publication Self Compacting Concrete in Bridge Construction (Ref. 189) recommend that hydrostatic pressures are used unless particular verification trials have been carried out. Westinghouse's response to the TQ was to refer to its forthcoming letter UN REG WEC 000370 (Ref. 125). However, this letter did not clarify the pressure, but repeated that that "*the maximum head of concrete acting on a module wall is 7 feet*".

670 I have raised **AF-AP1000-CE-46** to ensure that the final construction method using SCC does not exceed the wet concrete pressure specified in the methodology.

671 Section 4.3.2 of the methodology states that the stresses induced in the face plates from these wet concrete loads do not need to be considered as permanent. It refers to an analysis (APP-1100-SUC-005 Ref. 190) that shows that the concrete placement loads cause mainly bending in the plates, i.e. no or little net axial stress. Since in service the plate contribution is by axial stress, I accept this argument.

Moment and Axial Force

672 The required area of reinforcement for moment and axial load is based on ACI 349-01 (Ref. 22) for a reinforced concrete beam. The tension capacity of the section is based on the strength of the steel liner plates. The compression capacity of the module walls utilises both steel and concrete (Sections 4.2.3 and 4, Ref. 143). For bending, no account is taken of the steel plate on the compression side of the wall. The angles and channels are also neglected and the moment capacity for both horizontal and vertical axis is assumed to be equivalent (Section 4.2.2, Ref. 143).

Out-of-Plane Shear

673 The approach taken by Westinghouse for the design of SC wall sections subject to out-of-plane (OOP) shear forces is based upon the direct application of ACI 349-01 Chapter 11, assuming that SC elements will meet or exceed the expected capacity that would be achieved by a reinforced concrete section of identical thickness and concrete strength. Therefore, the OOP shear capacity is based primarily on the concrete strength, V_c .

674 Westinghouse has carried out comparisons with other reinforced concrete codes, namely Canadian Standards Association A23.3-04 (Ref. 191) and the AASHTO LRFD Bridge Design Specification 2004 (Ref. 192), which both use the modified compression field theory. Westinghouse's comparison shows that the ACI 349-01 V_c is 15% greater and 30% greater than these two codes respectively. Westinghouse has also submitted a single test for OOP shear. Although this is for the Shield Building construction it is based on a similar analogy. This test shows that the measured capacities were less than those obtained by the calculated ACI 349-01 value.

675 Westinghouse has shown that for the majority of locations, the OOP shear demand is at or below approximately 50% of the ACI 349 capacity calculated for the concrete. The steel trusses are not claimed as shear reinforcement in these areas since their spacing does not comply with ACI 349 for shear reinforcement. For areas of higher stress, Westinghouse has stated additional shear reinforcement will be provided, but no details are given (Ref. 86).

In Plane Shear

676 Westinghouse has used the rules for in-plane shear from ACI 349 for a reinforced concrete beam in order to size the plates. It has included the code reduction of shear resistance due to axial tension but has conservatively ignored any enhancement due to axial compression. Comparisons with alternative codes, such as the JEAG 4618 (Ref. 185) and the draft AISC N690 App 9 (Ref. 110), have also been provided (Ref. 143).

Shear Connection of Plate to Concrete

677 Shear connection is required to ensure composite action between the plate and the concrete and is provided by the shear studs, plus the angles and channels forming the trusses. Westinghouse document APP-1100-SUC-003 (Ref. 193) describes the capacity of the shear connection and the development of the plate strength. The AP1000 shear connection is intended to develop the full strength of the surface plate in the lesser of three times the wall thickness, or a quarter of the wall span. This is called the development length.

678 The shear strength and tensile strength of the studs are calculated in accordance with Appendix B of ACI 349-01, Anchoring to Concrete, and both have strength reduction factors applied as specified by the code.

679 The capacity of the shear connection could be affected by the use of self consolidating concrete. This was queried via RO-AP1000-079.A7. Westinghouse's response in their letter (Ref. 125) details the benchmarking tests carried out at Purdue University which show that there is "*additional local crushing of the concrete when compared to...standard concrete*" and that the "*local crushing results in a small amount of slip, but does not reduce the ultimate shear capacity of the studs.*" This argument is accepted but will need to be confirmed by the final mix design (refer to **AF-AP1000-CE-12** and **AF-AP1000-CE-13** in Section 4.7.2.4).

Connections

680 Various documents have been provided throughout Step 4 for the design of connections between modules. The base connection for CA20 has undergone several iterations with the latest submission on 18 January 2011, APP-CA20-S3C-002 Revision 4 (Ref 146).

681 Although several TQs were raised during Step 4 on the connections submitted, it became apparent that the designs were still being progressed. I therefore decided to halt assessment of connections to allow the documents to be finalised. The assessment of generic connections will therefore be carried out under GDA Issue action GI-AP1000-CE-01.A4.

Thermal Loading

682 The thermal transients applied to the CA Modules, specifically adjacent to the IRWST, result in high thermal loading. The temperature load cases were included in the linear CIS FE analysis. However, in response to RO-AP1000-079.A5, Westinghouse carried out a substantive piece of work to investigate cracking induced by both membrane and bending components of the thermal loads, namely APP-1100-S3C-017, Revision A, Non-linear Thermal Analysis of AP1000 CIS (Ref. 153). This was submitted too late to be included in this assessment report, but the assessment of it will be carried out under GDA Issue action GI-AP1000-CE-01.A5.

Fire Withstand

683 Certain walls and floors within the CA Modules are claimed as fire barriers (refer to ONR Internal Hazards Assessment Report ONR-GDA-AR-11-001, Ref. 35). These are claimed as three hour fire withstand, however no testing has been carried out for the SC walls (response to TQ-AP1000-913) and justification is based purely on concrete thicknesses. No justification is made on the effect of fire on the steel faceplate.

684 A calculation was given in Ref. 134 for the fire resistance of a typical CA floor module. Since this was received on 11th January 2011, there was insufficient time to assess it in detail. Therefore the assessment of it will be carried out under GDA Issue action GI-AP1000-CE-01.A6.

Reliability

685 RO-AP1000-079.A8 required Westinghouse to demonstrate that the reliability of the SC system is equivalent to that achieved by mature and established design codes for traditional steel and concrete structures.

686 Westinghouse's response in Section 8 of UKP-GW-GLR-018 Revision 0 (Ref. 73) states the measures claimed on how reliability is substantiated. These are presented in Table 22, with my comments against each measure.

687 A review against the SAPs was also given by Westinghouse, particularly paragraph 177 a) and b). The evidence given is that "*a large experience base for SC modules exists in Japan and Korea*" and "*that development of SC modules in Japan is based on extensive testing and resulted in JEAG 4618*" (Ref. 185). Section 8.2 of Ref. 73 states that "*the JEAG 4618 guidelines have since been issued as a formal code for the Japanese nuclear industry.*"

688 Westinghouse also referred to nuclear power plants (NPP) in Japan where these types of structures have been built and used in operation. Eight examples of SC structures within Japanese NPPs are listed, although no details of these structures were given to verify the claim on their provenance.

689 Westinghouse states that "*thorough and independent*" third party assessment has been undertaken in addition to its own QA requirements for design verification, under procedure 3.3.1 Design Reviews. "*Westinghouse has interfaced with multiple different*

international civil engineering design agents during the 20+ years of design development for AP1000 structural CA Modules. During the design of AP600 and AP1000 engineering” various organisations within civil engineering design and construction have contributed to this third party assessment. Most of these organisations are design partners with Westinghouse.

Table 22

Westinghouse Claimed Measures for Reliability for CA Modules

	Westinghouse Claim	ND Comment
1	conservative design methodology	This needs further substantiation.
2	extensive testing	The testing provided to date, although a useful benchmark, is not sufficient in quantity to fully substantiate reliability.
3	rigorous construction and construction inspection provisions	Claims have been made in various documents, however the detailed construction specifications will not be available until site specific stage. Therefore, more detail will be requested under AFs.
4	Weld Criteria	Straight copy of Section 9.5 of ESB Report.
5	Construction tolerances	Straight copy of Section 9.6 of ESB Report.
6	Quality Assurance And Inspection Of Construction	Straight copy of Section 9.7 of ESB Report.
7	Post-Placement Concrete Inspection	Copy of introduction of Section 9.8 of ESB Report and refers to remainder of section.

4.16.7.1.2 Findings on Design

General

- 690 Westinghouse has made significant progress towards justifying the CA Modules will satisfy the safety demands placed upon them for the AP1000. This has satisfactorily resolved the actions from RI-AP1000-002, subject to the final details being submitted under GDA Issue **GI-AP1000-CE-01**.
- 691 Particular concerns are the resistance to out-of-plane shear and in-plane shear, especially when in combination with other load actions, including construction and erection. The effect of thermal loads on the mechanical action of the individual elements of the SC walls also needs to be justified further.
- 692 My concerns have resulted in GDA Issue **GI-AP1000-CE-01** being raised to request further justification including eight actions. I have also raised Assessment Findings for site specific issues. The following text describes my assessment and the resulting issues and findings.

Design Documentation

- 693 The current set of documents submitted by Westinghouse range from high level documents to detailed calculation notes, TQ responses and letters. The UK Regulator requires a consolidated set of documentation to adequately describe the structure that is the basis of Westinghouse's submission under the GDA process. This is to ensure any changes made after an iDAC/DAC is issued are easily identifiable. This is requested under Action A1 of **GI-AP1000-CE-01**.

Fabrication and Erection Stresses

- 694 Westinghouse considers the locked in stresses from fabrication and erection are not additional to design stresses and claim they will self relieve. Further justification of these will be needed at site specific stage once the construction method statement has been finalised. This is captured in the Assessment Finding below which must be addressed prior to milestone 1 – long lead item procurement.

AF-AP1000-CE-45: *The licensee shall provide justification that the construction methods used for fabrication and erection of the CA Modules do **not** result in additional locked in stresses that need to be included in the final design capacity calculations (as claimed in the GDA design methodology, APP-GW-SUP-001 Revision 2).*

Concrete Placement Stresses

- 695 The rate quoted for concrete placement is applicable to normal weight concrete, but not to self compacting concrete. Therefore, further justification of this will be needed at site specific stage once the construction method statement has been finalised. This is captured in the Assessment Finding below, which must be addressed prior to milestone 3 – NI safety related concrete.

AF-AP1000-CE-46: *The licensee shall provide justification that the concrete placement rate for the specific concrete mix used does **not** result in higher stresses in the steel faceplates than that stated in the GDA design methodology, APP-GW-SUP-001 Revision 2.*

Moment and Axial Force

- 696 The demand for out-of-plane moment is very low compared with the ACI 349-01 capacity calculated. The method adopted is generally acceptable; however the combination with other loads needs further justification (see below).

Out-of-plane Shear

- 697 The OOP shear behaviour is a critical item for civil/structural nuclear safety since failure modes associated with this mechanism are assumed to be brittle, and must therefore be robustly protected to ensure the design meets normal design basis and beyond design basis loading demands.
- 698 I opine that for the current demand versus capacity utilisations for the majority of locations, the ACI 349 design values are conservative but the method is not universally applicable for higher utilisations. Therefore, additional limitations/acceptance criteria must be included in the GDA design methodology to limit the level of utilisation of the concrete shear strength V_c . Above this limit, additional shear reinforcement is to be provided and justification of the design of this is required.

699 The above further justification for out-of-plane shear is requested under Action A2 of **GI-AP1000-CE-01**.

In Plane Shear

700 It is accepted that the methodology used by Westinghouse is conservative for pure in-plane shear. However, when combined with out-of-plane moments and/or tension, I do not consider the methodology to be generally applicable in the high demand region. This is because Westinghouse does not share the in-plane shear symmetrically between the two plates, as specified in JEAG 4618 and draft N690 Appendix 9. The ACI 349 approach also takes contribution from the concrete as well as the steel, whereas the two alternative codes take only the steel contribution.

701 I accept that, for the current demand versus capacity utilisations, the design method used is acceptable but it is not universally applicable to combinations of high in-plane shear, moment and axial load. Westinghouse's asymmetric distribution of in-plane shear stresses between the plates needs further justification since it does not align with alternative codes. Likewise, the contribution to shear capacity from the concrete is not utilised by the alternative codes. The Westinghouse current design methodology needs to have specific limits on demand outside of which the ACI 349-01 methodology will not apply in the case of in-plane shear.

702 The above further justification for in-plane shear, with combined loadings, is requested under Action A3 of **GI-AP1000-CE-01**.

Shear Connection

703 The strength reduction factor applied to the shear studs is 0.75, whereas the current version of ACI 349 (2006) specifies 0.65. This needs to be justified further.

704 I have assessed the validity of considering angles and channels as equivalent shear studs and what their capacity will be. The expression used for the angle is appropriate; however I do not agree with the calculation for the channel. This may affect the calculation of the development length for the plate.

705 The above further justification for the shear connection is requested under Action A4 of **GI-AP1000-CE-01**.

Connections

706 The performance of the connections between the modules and reinforced concrete and between different elements of the modules is crucial to the adequacy of the modules. My assessment aimed to sample the concept design as a minimum and preferably the detailed calculations of certain connections.

707 GDA Issue Action A5 of **GI-AP1000-CE-01** requires a sample of generic connections to be agreed between ONR and Westinghouse. These are to be assessed once sufficient design details are available.

Thermal Loading

708 My assessment highlighted that the effects of high thermal loading applied to the CA Modules, was not necessarily captured in the linear FE analysis with smeared shell elements. This is because the hot face plate would try to expand and thus be put under compression, which would affect the shear studs and trusses. Concrete cracking would also occur, which may not be modelled effectively.

709 The non-linear thermal analysis by Westinghouse (Ref. 153) was submitted in draft form in March 2011. Therefore, Action A6 of **GI-AP1000-CE-01** is intended to allow Westinghouse to develop this to an approved document and for it to be subsequently assessed by ONR.

Fire Withstand

710 The effect of fire on the CA Modules needs to be quantified, such that the risk to structures supporting Category 1 nuclear safety plant can be assessed.

711 I have concerns with respect to the following:

- Loss of the faceplate – the level of fire that will achieve this and the resulting effect on the load carrying capacity of the remaining structure, needs to be quantified.
- Build up of vapour pressure inside the wall due to fire. Westinghouse considers this a local effect (TQ-AP1000-913) but I believe this is not the case for a full room burn.
- Overall response of the whole structure to the temperatures in the fire, i.e. combination of induced thermal moment with other loads and deflections.

712 The Internal Hazards assessment has raised a GDA issue on fire barriers (**GI-AP1000-IH-01.A1**). Action A7 of **GI-AP1000-CE-01** has been raised in conjunction with **GI-AP1000-IH-01.A1** since it requests evidence on the effect of fire on the CA Modules generally, not only where they are claimed as fire barriers.

Reliability

713 Insufficient evidence on reliability of SC structures has been submitted to date. The claims made in the response to RO-AP1000-079.A8 (Ref. 73) are that independent third party assessment has been carried out but no evidence of these reviews, or of the true independence of the assessors, has been submitted.

714 Existing structures used in Japanese NPPs are listed but Westinghouse has been unable to provide evidence on design methodologies or experience in service to justify the claims on their provenance. Claims made to existing Japanese structures need to be substantiated, especially since these seem to have been designed to a specially developed code used only in Japan, not to the claimed ACI 349-01.

715 I recognise that US codes are not reliability based. However, European codes are, based on decades of experience of structures. The problem is the lack of real experience of these types of SC structures.

716 It is my expectation that further substantiation on the reliability of SC modules is required and demonstration that the target reliabilities can be provided, using the design methodologies, adopted.

717 The further justification described above for reliability is requested under Action A8 of **GI-AP1000-CE-01**. However, it has been agreed with Westinghouse that claims made on existing structures in Japan will not be used in its response to A8, unless detailed information can be provided.

Benchmark Testing

718 The tests undertaken by Westinghouse for the ESB give interesting information. However, they are too few in number to be statistically robust. Several queries on testing

were raised in TQ-AP1000-1085 in terms of material properties of tests specimens and interpretation of results, which illustrate uncertainties even with the few tests undertaken.

- 719 The tests for the CA Modules were carried out late in the Step 4 period and results have not been assessed. Again, the number of tests is few in number and, although they contribute to the justification of the claims made, it is insufficient to base a reliability argument purely on these and the ESB test results. Submission and assessment of these tests results is captured under **GI-AP1000-CE-01.A8**.

4.16.7.2 Construction Provisions

4.16.7.2.1 Assessment

- 720 The potential for locked in stresses from the fabrication and erection processes, needs to be included in the design to ensure these are not additive or have a detrimental effect on the structure's performance in service. This is discussed in Section 4.16.7.1 above. This section concentrates more on the detail of the quality control of these construction activities.
- 721 The response to RO-AP1000-079.A8 (Ref. 73) provides a description of the "*rigorous construction and construction inspection provisions*" that Westinghouse recommends for the construction of the CA Modules. These are reasonably comprehensive but are generalised statements rather than specifics. Westinghouse's approach is that the construction method statements can only be finalised once a contractor is appointed.
- 722 The Nuclear Island Structural Modules Specification, APP-GW-Z0-100 Revision 2 (Ref. 194) defines the requirements for the module fabricator who undertakes design, fabrication, assembly, shipping, etc of the modules to a point where they are ready to be installed in the plant. Transporting the modules from site assembly area to the plant area will be carried out by others. All modules are included, i.e. CA, CB, CH and CS modules.
- 723 The specification (Ref. 194) for the module fabrication (up until it is ready to be lifted into final position) is satisfactory. This is the only specification that has been assessed during Step 4. A different contractor will be responsible for lifting the modules into final position and thus this contractor will be responsible for using the correct lifting rigs and ensuring the module is not overstressed. Post lift checks may be carried out by a different contractor again.
- 724 The roles and responsibilities between different contractors will need to be explicitly defined at site stage. Final substantiation will be required from all contractors that the construction and fabrication methods achieve the designers' intent. This is captured as **AF-AP1000-CE-47** below.
- 725 Westinghouse has not specified the welding procedures to be used and the testing methods on a structure by structure basis. Generalised statements are made in various documents submitted, but no specific details are given. Provision of this information will be required prior to construction and so this is captured in **AF-AP1000-CE-48** below.
- 726 Concrete placement techniques will need to be verified at site specific stage, particularly for the use of self consolidating concrete. Westinghouse states that "*mock-ups of the walls are being used to develop the placement procedures*" (Letter WEC000370 Ref. 125). It also states that "*cold joints within the module walls are not planned*" and that "*procedures will also be developed for preparation of construction joints within the walls if necessary due to un-planned events*".

727 The arguments on concreting are accepted, but will need to be confirmed by the final construction method statements (refer to **AF-AP1000-CE-49** below).

728 Refer to Section 4.7 for assessment of materials.

4.16.7.2.2 Findings for Construction Provisions

729 Roles and responsibilities will need to be defined at site specific stage. See **AF-AP1000-CE-47** below which must be addressed prior to milestone 1 – long lead item procurement.

***AF-AP1000-CE-47:** The licensee shall provide the management plan for the interfaces between different contractors involved in the positioning of the SC modules. The licensee shall also provide the detailed specifications and construction method statements for each task, with specific reference to post lifting inspection and testing to ensure no detrimental effect on the structures' design intent.*

730 Welding procedures and testing methods to be used in the fabrication will need to be assessed at site specific stage. This is captured as the Assessment Finding below which must be addressed prior to milestone 1 – long lead item procurement. See also **AF-AP1000-CE-45** in paragraph 694.

***AF-AP1000-CE-48:** The licensee shall provide the full details of the weld procedures and testing proposed for the various SC modules at the site specific stage.*

731 The welding integrity for the spent fuel pool is discussed in Section 4.16.10 and a separate Assessment Finding is raised for that structure.

732 The following Assessment Finding is raised with respect to construction methods for concreting. This must be addressed prior to milestone 1 – long lead item procurement.

***AF-AP1000-CE-49:** The licensee shall provide the full details of the construction methods for concreting the various SC modules at the site specific stage. The licensee shall justify that these meet the requirements of the generic design.*

733 Refer to **AF-AP1000-CE-46** in paragraph 695 above for my finding on concrete placement rate.

4.16.8 Assessment of ESB SC Cylindrical Wall

4.16.8.1 Design Provisions

4.16.8.1.1 Assessment

734 The submission for the Shield Building is mainly contained within one very large report, the Design Report for the AP1000 Enhanced Shield Building (Ref. 72). This has undergone three revisions during GDA Step 4 and been the subject of many meetings between Westinghouse and the US NRC, as well as ONR.

735 The construction of the SC portion of the ESB cylindrical wall is essentially the same as that used for the CA Modules. However, the provision of closely spaced tie bars means that these can be considered as shear reinforcement in accordance with the claimed code ACI 349-01 (Ref. 22).

Tie Bars

- 736 The 0.75 inch tie bars are deformed wire reinforcing bars to ASTM specification A496 (Ref. 195). A496 does not specify the maximum values of yield or tensile strength; hence compliance with ACI 349-01 for seismic design would rely on tests on the material used. The small margin between yield and tensile strengths means the bars have low ductility and this also has implications on the performance as shear connectors.
- 737 The suitability of the tie bar material was questioned by ONR due to its low ductility (TQ-AP1000-1085 question 59). This subject was also discussed at the US NRC meeting in June 2010 following which, Westinghouse provided stress/strain test data in Appendix H of the next update of the ESB Design report (Ref. 72). This data indicates that the strain at maximum loads is much less than 5%. In Europe, reinforcement is classified in terms of ductility, i.e. the strain at the maximum force. The European seismic code EN 1998-1-1 (Ref. 115) requires that reinforcement has a strain at maximum load of at least 5% (Class B) or 7.5% (Class C). According to the British Standard for scheduling, dimensioning bending and cutting of steel reinforcement for concrete, BS 8666 (Ref. 196), for bars over 12mm, the ductility class would normally be at least Class B.
- 738 Full justification of the design tensile load present in the tie bars due to combined loading effects, was requested in question 8 of TQ-AP1000-1085. A response was received on 26 January 2011 (Ref. 181) and so was received too late to include in this report.
- 739 Unlike conventional RC construction in which shear links are taken around the longitudinal reinforcement, the ESB SC wall depends on the welding of the tie bars to the steel face plates. The weld detail is presented in Ref. 72.

Out-of-Plane Shear

- 740 The tie bars are spaced sufficiently close together to qualify as shear reinforcement according to ACI 349-01. Therefore, shear resistance, V_s , provided by the tie bars has been calculated by Westinghouse.
- 741 The third revision of the ESB report (Ref. 72) included further evidence that the out-of-plane shear resistance does not rely on the concrete component, V_c , as calculated in accordance with ACI 349-01. This is presented in Appendix H and Westinghouse states that the *“maximum demand versus capacity ratio for only the V_s contribution is about 58 percent for the mechanical load combinations; for thermal load cases the maximum ratio is about 92 percent when only V_s is considered”*. The plots in Appendix H show that these maximums are very localised.

In-Plane Shear

- 742 Westinghouse has used the same asymmetric distribution of in-plane shear as the CA Modules, whereas the JEAG 4618 and draft AISC N690 App N9 both consider that the in-plane shear is shared symmetrically between plates. This was queried in TQ-AP1000-1085 question 15. The difference between the two approaches would only be significant if the out-of-plane moment was a large proportion of the moment resistance. Thus the Westinghouse approach is applicable only to the specific demand range given for the ESB SC wall.
- 743 The ACI 349-01 approach also allows contribution from the concrete, whereas JEAG 4618 and draft AISC N690 App N9 do not.

Shear Connection

- 744 Westinghouse has used 0.75 from ACI 349-01 B.4.4 for reduction of shear strength for the nelson studs. However:
- ACI 349-06 specifies 0.65, but allows 0.75 for the load combinations from ACI 349-01.
 - the current AISC 360-10 specifies 0.65.
 - the draft AISC N690, App N9 will be using a factor of 0.65.
- 745 Westinghouse claims that the tie bars are equivalent to shear studs. TQ-AP1000-741 was raised to query this but the response was unsatisfactory and so a further TQ was raised, TQ-AP1000-1176. A response to this was received on 8 January 2011, which compared the tie bar strength from tests. However, the materials used in the tests are significantly different to those for the final structure and so this response is not satisfactory.
- 746 The test results reported by Westinghouse in the ESB Design Report indicate that the shear strength of the tie bars is significantly less than that of the studs. The weld detail of the tie bars and studs to the surface plate is also very different.
- 747 Since the tie bars also perform the function of shear reinforcement, Westinghouse was asked to consider the interaction effects of tension and shear in question 8 of TQ-AP1000-1085. In their response, Westinghouse continues to assume that the shear resistance of the tie bar is equal to that of a stud.
- 748 TQ-AP1000-1085 question 14 requested consideration of simultaneous tensile and shear forces in both shear connectors. The response included a calculation of forces in the studs due to plate curvature as 3.2kips but with no mention of a coincident shear load on the stud.
- 749 The development length is calculated assuming the studs and tie bars provide the same shear resistance. The testing carried out by Westinghouse does not illustrate this.

Thermal

- 750 The thermal load cases considered for the ESB SC wall are not as onerous as that for the CA Modules, due to environment variations rather than operational. Nevertheless, my assessment considered whether cracking of the concrete, due to thermal loading, could have a detrimental effect on the performance of the wall in a subsequent seismic event. Frequent/daily thermal cycles could lead to cyclic forces on shear connections adjacent to cracks and degrade their capacity.
- 751 Amec carried out non-linear analysis of the wall and found that solar gain could have a significant effect on the structure (Ref. 28). This was presented to Westinghouse at a technical meeting in September 2010.

Fire

- 752 The ESB SC wall is not claimed as a fire barrier. The argument is, areas adjacent to the cylindrical wall do not have significant fire load and maintenance access control procedures would limit combustible materials being taken into those areas
- 753 No documentation has been submitted to substantiate the effect of fire on the SC structure.

Reliability

- 754 The reliability of the Shield Building has been presented in qualitative terms. As discussed under CA Modules, US codes are not reliability based, whereas European codes are. However, there is a lack of proven experience for these types of SC structures.
- 755 Westinghouse presents in Section 11 of the ESB Design Report (Ref. 72) a description of the design margins and conservatisms. These are based on the following measures:
- ESB design features that increase strength and ductility.
 - Conservatisms in seismic analysis methods.
 - Conservatisms in code allowables.
 - Margin to code allowables.
 - Reserve strength demonstrated by non-linear analysis.
 - Design margin associated with the Shield Building structural materials.
- 756 TQ-AP1000-1085 question 92 queried the argument that there are conservatisms in factors of safety and capacity reduction factors of ACI 349-01. Load factors do not represent conservatism but rather recognize that loads are probabilistic and not deterministic. No response had been received at the time of writing this report.
- 757 The argument for design margin on materials is based on the steel plate, reinforcing steel and the concrete. However, as described above, the tie bars do not comply with European requirements for reinforcement ductility and so a separate argument is needed.
- 758 Section 11.3 of the ESB Design Report presents the calculation of reliability values for certain parts of the Shield Building. The assessment of this is discussed in Section 4.22.

4.16.8.1.2 Summary and Findings

- 759 Westinghouse has made significant progress in satisfying my expectations in terms of the evidence submitted to substantiate the ESB SC composite wall. However, further evidence is required before a DAC can be issued. Particular concerns are the suitability of the tie bar material and the calculation of coincident loads upon it.
- 760 My concerns have resulted in a GDA issue **GI-AP1000-CE-02** being raised specifically on the ESB SC wall. Although some of the actions are very similar to those for the CA Module **GI-AP1000-CE-01**, I think it prudent to have two separate GI's to reflect the differences in the two novel SC designs.

Tie Bars

- 761 The tie material specified by Westinghouse does not appear to comply with European requirements for reinforcement in seismic design. The tie bars should be designed to ensure that ductile mechanisms develop and/or a high margin against failure is present. ONR has not previously rejected the tie bar material; however the choice of the A496 material grade is questionable and either needs to be justified further or an alternative proposed.
- 762 I note that the calculation provided in the response to question 8 of TQ-AP1000-1085 does not address all the potential coincident loads or mechanical effects; the most notable omissions being curvature and thermal. The explanation given as to why axial thermal stresses are not included needs to be justified further. Furthermore, the value of

loads used in this response is not consistent with Table H.1-1 of the ESB Design Report (Ref. 72) which indicates larger shears and ratios when thermal loads are included.

763 Action A1 of **GI-AP1000-CE-02** requires Westinghouse to provide further justification on the tie bar material specification and Action A2 on the calculation of coincident force versus capacity.

764 I conclude that Westinghouse has submitted sufficient evidence on the weld detail of the tie bars to the plates. Information on the testing carried out to demonstrate its suitability has also been submitted. The final welding procedures will need to be confirmed at site specific stage and so I raise the following Assessment Finding which must be addressed prior to milestone 1 – long lead item procurement.

***AF-AP1000-CE-50:** The licensee shall provide the full details of the weld procedures and testing proposed for the tie bars to the steel faceplates for the ESB SC cylindrical wall. These procedures must ensure that the weld is stronger than the tie bar and satisfies all the design assumptions/requirements.*

Out-of-Plane Shear

765 Action A3 of **GI-AP1000-CE-02** for the ESB SC wall requires Westinghouse to update its design methodology to make it clear that the demand out-of-plane shear is taken on the tie bars alone.

766 I accept that calculation of V_s alone to ACI 349-01 gives sufficient margin to the design of the ESB for mechanical loadcase. This is in contrast with the design of the CA Modules, where $(V_c + V_s)$ has been claimed. I do not accept that the full value of V_c , as calculated by ACI 349-01, can be mobilised and so **GI-AP1000-CE-01.A2** on the CA Modules requires further limits on V_c for out-of-plane shear resistance. Since V_c is not claimed for the ESB, there is no need for a similar action in **GI-AP1000-CE-02**.

767 To substantiate the claim that V_s calculated to ACI 349-01 is conservative, **GI-AP1000-CE-02.A3** also requires Westinghouse to provide a comparison of the proposed ACI 349-01 design methodology for out-of-plane shear and provision of shear reinforcement with alternative codes.

In-Plane Shear

768 I conclude that, for the current demand versus capacity utilisations, the design method used is acceptable but it is not universally applicable to combinations of high in-plane shear, moment and axial load. Therefore, additional limitations/acceptance criteria must be included in the GDA design methodology, outside of which the ACI 349-01 analogy is no longer applicable.

769 Action A4 of **GI-AP1000-CE-02** requires Westinghouse to provide further substantiation on in-plane shear resistance.

Shear Connection

770 I do not accept that the substantiation of the shear studs and tie bars includes all the load effects upon them, or that they provide the same shear resistance. There are also queries on the strength reduction factor for the studs and calculation of the development length.

771 Action A5 of **GI-AP1000-CE-02** requires Westinghouse to provide further substantiation on the shear connection for the ESB SC wall. This action slightly overlaps with A1, since the combination of tension and shear on the tie bars must be considered.

Thermal

772 The effect of thermal loads on the ESB SC wall requires further substantiation. The combination with other loading actions needs to be substantiated. For instance, the restraint forces in the studs/ties induced by restraining the compression plate against expansion must also be combined with the mechanical actions.

773 Westinghouse has committed to provide external cladding to the ESB to prevent solar gain. However, Westinghouse needs to provide a justification for the cladding that is based upon its own analyses and design work, i.e. an appraisal of the solar gain on the steel face plates, thus resulting in thermal performance criteria for the cladding.

774 Action A7 of **GI-AP1000-CE-02** requests further substantiation on the above.

Fire

775 Action A8 of **GI-AP1000-CE-02** is concerned with the structural stability of the ESB circular SC wall following a potential fire. I have concerns with respect to the following:

1) Loss of the faceplate – the level of fire that will achieve this and the resulting effect on the load carrying capacity of the remaining structure need to be quantified.

2) Build up of vapour pressure inside the wall due to fire. Westinghouse considers this a local effect (TQ-AP1000-913) but this claim has not been fully justified.

3) Overall response of the whole structure to the temperatures in the fire, i.e. combination of induced thermal moment with other loads and deflections.

776 A quantification of the fire magnitude that the structure can withstand without structural collapse is needed. This should include possible malicious fires outside the building and internal fires within the Shield Building annulus or in the Auxiliary Building adjacent to RC/SC connections. Normal fire load could increase due to operation and maintenance teams not complying with procedures and taking prohibited materials into an area.

Reliability

777 As with the CA Modules, there is a lack of reliability data for this type of structure. The evidence presented does not identify the target reliabilities for Class I SC structures or demonstrate that the design methodology can achieve them. This demonstration can be undertaken using whatever methods are seen as appropriate; however the following should be addressed.

- Reliability of the Code in terms of mechanistic representation of structural behaviour.
- Assumptions over the reliability of the engineer using the code.
- Suitability of partial safety factors adopted in the design for both materials and loads.
- Comparison with other codes for nuclear work.
- Assumptions over the quality of materials/construction.
- Assumptions made over the long term behaviour of materials.
- Assumptions made over the probability of the loadings used in the design.

- 778 Action A9 of **GI-AP1000-CE-02** requires Westinghouse to demonstrate that the reliability of the SC system is equivalent to that achieved by mature and established design codes for traditional steel and concrete structures.

4.16.8.2 Connections

4.16.8.2.1 Assessment

Base Connection

- 779 The ESB SC wall is connected to the RC parts at the base and at steps between them, such that there are vertical and horizontal connections between lengths of wall. My assessment has focused on the base connection and this has been used to sample Westinghouse's design methods.
- 780 The base connection is presented in Section 4.2.1 of Ref. 73. It was also discussed at the US NRC meeting in June 2010.
- 781 The in-plane shear is applied to the concrete at the base of the connection and a large proportion must be transferred to the plates either side of the SC construction. The structural load path required to achieve this has not been fully demonstrated. Queries were raised on the connection design via TQ-AP1000-1085, questions 33, 35 and 36. A response was received on 1 March 2011 and so was too late to be included in GDA Step 4. However, it will be assessed as part of the response to **GI-AP1000-CE-02.A6**.

Auxiliary Roof Connection

- 782 This connection is shown in Figure 4.2-6 of Ref. 73 and comprises a steel lug welded to the outside of the ESB SC wall. The Auxiliary Building roof is then cast onto the lug; however Figure 4.2-6 does not show how the roof slab reinforcement is detailed around the lug. Questions 41 and 42 of TQ-AP1000-1085 were raised to query the load path from shear lug and roof slab reinforcement into the ESB wall. The response received on 26 January 2011 was not satisfactory since the force transfer into the ESB wall will induce additional forces in the tie and studs, which need to be taken into account and additional shear connectors provided if necessary. The current detailing of the auxiliary roof slab will not transfer the forces to the shear lug; hence additional, properly anchored reinforcement will be required in the roof slab.

Air Inlet Wall

- 783 The air inlet region is wider than the typical section of cylindrical wall. The detail requires the inside faceplate to change direction. The need to address the forces induced by the change in direction was raised at the joint meeting with US NRC in June 2010. In Revision 3 of the ESB Design Report, there is a calculation in Appendix H that suggests that tie bars in the wall may be sufficient. This calculation does not appear to take account of local stresses in the faceplates. In Revision 3, Figures 5.1-6 and 5.1-7 have also been revised and show plates at the change in direction; the plates may be an appropriate solution. It is not clear that this issue has been resolved and, as such, it is raised under **GI-AP1000-CE-02.A6** on connections for the ESB.
- 784 It should also be noted that these calculations could also be affected by the review of the tie bars required under **GI-AP1000-CE-02.A2**.

4.16.8.2.2 Findings on Connections

785 Further justification of the above three connections has been requested via Action A6 of **GI-AP1000-CE-02**. This will include assessment of the responses to the various questions in TQ-AP1000-1085 and further support from Westinghouse to ONR as required.

4.16.8.3 Construction Provisions

4.16.8.3.1 Assessment

786 The construction and construction inspection provisions are described in Section 9 of the ESB design report. No other specifications have been assessed during Step 4.

787 The procedures recommended by Westinghouse for fabrication and erection of the ESB rings are similar to those for the CA Modules. Therefore, the discussion in Section 4.17.8.2 is relevant.

788 The concrete placement rate is not specified within the documentation for the ESB SC wall. This will need to be calculated and any locked-in stresses included in the design of the wall components.

789 Post concreting inspection has been appraised by Westinghouse in Section 9.8 of Ref. 73. The type of defects that could occur have been identified and the areas where there may be problematic pour sequences due to the wall layout. Three trial panels or mock-ups have been identified, which are the base connection, horizontal connection and the air inlet region (Figure 9.4-1). Video of the air inlet region mock-up was presented at the ONR technical meeting in September 2010. Defects were deliberately introduced into this trial panel to test the ability of the chosen post concreting inspection methods to detect them.

790 Consideration has also been given on the acceptance criteria for critical defects in terms of how they could affect the design.

4.16.8.3.2 Findings

791 I raise the following two Assessment Findings on fabrication and erection of the ESB, which must be addressed prior to milestone 1 - long lead item procurement.

AF-AP1000-CE-51: *The licensee shall provide the management plan for the interfaces between different contractors involved in the positioning of the ESB SC modules. The licensee shall also provide the detailed specifications and construction method statements for each task, with specific reference to post lifting inspection and testing, to ensure no detrimental effect on the structures' design intent.*

AF-AP1000-CE-52: *The licensee shall provide the full details of the weld procedures and testing proposed for the ESB SC modules at the site specific stage.*

792 A similar Assessment Finding to that on the CA Modules is raised with respect to concrete placement rate. This must be addressed prior to milestone 3 – NI safety related concrete.

AF-AP1000-CE-53: *The licensee shall provide justification that the concrete placement rate for the ESB SC wall does not induce higher stresses in the steel faceplates than that accounted for in design calculations.*

793 I am satisfied that post concreting defects have been adequately appraised by Westinghouse and potential inspection techniques identified to ensure such defects are detected should they occur. However, the details of the trial on the air inlet region have not been submitted. Also the final methods will not be confirmed until construction stage. Therefore, I raise the following Assessment Finding which must be addressed prior to milestone 3 – NI safety related concrete.

AF-AP1000-CE-54 *The licensee shall confirm the post concreting inspection techniques to be used for the ESB SC wall and justify that these will detect potential defects that have been identified as critical to the design performance.*

4.16.9 Floor Modules

4.16.9.1 Assessment

794 The module design methodology APP-GW-SUP-001 (Ref. 86) includes a methodology for the design of the floor modules in Section 8 and there is a distinction between those floors inside and outside the containment.

795 The typical floor module inside the containment consists of steel tee sections welded to horizontal steel plates stiffened by transverse angle stiffeners supported by deeper beams and girders. The design is to be based on Section Q1.11 of AISC N690-1994 (Ref. 96) as composite structures for downwards load, such that the steel plate on the soffit acts as tension reinforcement. In-plane loads are to be taken just by the steel plate. For upwards loads, the steel members are relied upon to provide the load carrying capacity and no credit is taken for composite action. The design is therefore to the steelwork sections of AISC N690-94.

796 The floor modules outside of the containment, i.e. within module CA20, are designed as half steel concrete (HSC) to ACI 349-01 (Ref. 22) for both downwards and in-plane loads. HSC modules comprise a steel soffit plate with angle or tee section stiffeners cast into the concrete. For positive bending, the steel plate will be in tension and therefore the steel plate and stiffeners shall be designed as the bottom reinforcement. For negative bending, compression will be resisted by the concrete and stiffened plate and the tension by top rebar in the concrete. Again, for upwards loads, the design is non-composite to AISC N690-94.

797 The AP1000 methodology (Ref. 86) states that both types of floor modules are to be designed as simply supported beams. However, Westinghouse also states that the design of the connection at the ends should take account of the moments from the FE analysis.

798 Detailed sample of calculation note APP-1130-S3C-001 (Ref. 197) Analysis of Containment Internal Structures highlighted that this uses the results of an FE analysis, i.e. allows for two-way spanning, which is not in accordance with the design methodology. This document also refers to Design Guide for Reinforcement in Walls and Floor Slabs (Ref. 198) where in-plane shear forces are split between concrete and top and bottom reinforcement. TQ-AP1000-1194 was raised to query this and the Westinghouse reply states that the methodology in Ref. 86 will be applied to the floors in the final calculations.

4.16.9.2 Summary and Findings

799 The two types of floor module I have assessed are very similar in structural form. However, distinctly different design methodologies have been used; one to the steel code

and one to the concrete code. The reasons for this are unclear, but appear to be historical rather than an engineering strategy. The N690 method is to an established code and so is accepted. The claimed ACI 349 methodology is outside the applicability of the code; clause 1.1.7.2 states that “*This code does not govern the design of structural concrete slabs cast on stay in place, composite steel from deck.*”

800 Irrespective of which design methodology is used, the steel plate must have sufficient interface shear connectors to ensure it acts compositely with the concrete.

801 For floor modules inside the containment the methodology states that “*composite action of the steel section and concrete fill is assumed based on meeting the intent of the requirements of Section Q1.11.1 for beams totally encased in the concrete*”. There will be composite action due to encasement of the tee section and the transverse angle stiffeners will also act to transfer load between the concrete and steel. For floor modules outside containment, no description of the shear transfer mechanism is given in the methodology (Ref. 86). In its response to TQ-AP1000-913, Westinghouse included images of a “typical CA module floor”, which show shear studs for CA20 and these would be a logical way of providing the required action.

802 For modules inside and outside the containment, there appear to be mechanisms to transfer shear between the steel and the concrete to create the required composite action. It is not clear whether these are sufficient for the forces to be resisted by the floor and this will need to be justified in the final calculations. This is raised as an Assessment Finding, which must be addressed prior to milestone 1 – long lead procurement item.

AF-AP1000-CE-55: *The licensee shall justify that the final detail used for interface shear connectors for both ACI349 HSC floor modules and AISC N690 composite floor modules will provide the required shear transfer to ensure composite action.*

4.16.10 Summary and Findings

803 Westinghouse has submitted considerable amounts of additional evidence during GDA Step 4 to substantiate the SC module design for the CA Modules, the ESB SC cylindrical wall and the SC floor modules. This evidence has mainly been targeted at answering the concerns raised via RO-AP1000-079 for the CA Modules. However, the responses have formed a significant part of the evidence required for satisfactory completion of RI-AP1000-002.

804 I consider the conclusion reached at the end of Step 3 to be still valid, i.e. this type of composite structure is outside the scope of applicability of the substantive provisions of the claimed code ACI 349-01. The current version ACI 349-06 (2006 version) also does not include composite construction. Therefore, claims of conservatism cannot reasonably be justified based upon the reference codes highlighted in the design.

805 Due to my conclusions, I have raised two GDA Issues to address the specific shortfalls in the GDA submission. I have also raised several Assessment Findings to capture comments raised during my assessment, which are more appropriately addressed during site specific phase or during finalisation of construction details. These are detailed below.

4.16.10.1 Summary on CA Modules

806 Westinghouse has shown that the demand on the CA Modules is relatively low compared with the ACI 349-01 capacities calculated. Westinghouse has also committed to providing additional shear reinforcement in localised areas of high shear.

-
- 807 I opine that the structural form of the CA Modules will have more than sufficient capacity for the demand placed upon them for the majority of locations. However, the ACI 349-01 design method is not universally applicable for higher utilisations. Additional limits must be placed upon the code allowables to account for the fact they are not strictly applicable. The way forward is to provide further justification that the CA Modules design is satisfactory when compared with other design methods or first principles. Westinghouse has committed to providing alternative calculations to prove that the results obtained from its declared design methodology are conservative. This is still in progress, and needs to be completed under GDA Issues.
- 808 I recognise that there are currently no fully applicable codes available. Alternative calculations to other established code, which again may not be directly applicable to SC construction, will nevertheless provide further confidence in the margin calculated. The first applicable code is currently under draft, i.e. AISC N690 Appendix N9, and further confidence can be gained by appraising the CA Module design against the current draft.
- 809 The confidence that structures designed to established codes will perform as designed is developed on the basis that the design methods become more refined with the passage of time, as a better understanding of materials and long term performance of structures built to a code, is established. The reliability attached to SC structures is therefore currently unsubstantiated; for instance, no long term data has been submitted on the performance of SC structures or on their performance under extreme environmental and accident conditions.
- 810 To capture the above concerns, I have raised GDA Issue **GI-AP1000-CE-01** on the CA Modules with eight associated actions on:
- A1: Consolidated documentation.
 - A2: Additional acceptance criteria for out-of-plane shear resistance.
 - A3: Additional, confirmatory calculations for in-plane shear resistance.
 - A4: Additional substantiation of shear connection.
 - A5: Justification of connections for CA Modules.
 - A6: Further justification of SC's ability to withstand thermal loading.
 - A7: Further justification of SC's ability to withstand fire.
 - A8: Reliability.
- 811 Five Assessment Findings have been raised on CA Modules, **AF-AP1000-CE-45** to **AF-AP1000-CE-49**, which must be addressed prior to the fabrication of the CA Modules which are long lead items.

4.16.10.2 Summary on ESB SC wall

- 812 Westinghouse has shown that the demand on the ESB SC wall will have a significant margin based on the ACI 349-01 capacities calculated. Westinghouse has also shown that the tie bars can act as shear reinforcement for out-of-plane shear, without needing to utilise the concrete contribution.
- 813 Further justification is requested via **GI-AP1000-CE-02** with nine associated actions for various aspects of the generic design, as described above. These actions are:
- A1: Further justification of suitability of material used for tie bars.
 - A2: Further substantiation for the demand calculation and capacity for the tie bars.
 - A3: Comparison of out-of-plane shear resistance with alternative codes.

- A4: Additional, confirmatory calculations for in-plane shear resistance.
- A5: Additional substantiation of shear connection.
- A6: Justification of connections between ESB SC and RC walls.
- A7: Further justification of SC's ability to withstand thermal loading.
- A8: Further justification of SC's ability to withstand fire.
- A9: Reliability.

814 Five Assessment Findings, **AF-AP1000-CE-50** to **AF-AP1000-CE-54**, are raised for site specific items.

4.16.10.3 Summary on SC Floors

815 The design of the SC floors, which follow the same methodology as the CA Modules, require further justification. Two significant aspects of the floor module design are covered by the following GDA Issue Actions:

- **GI-AP1000-CE-01.A5** connection of floor module to SC wall.
- **GI-AP1000-CE-01.A7** fire resistance of floor modules.

816 **AF-AP1000-CE-55** is raised on the construction details of the shear connectors.

4.17 Spent Fuel Pool Liner

4.17.1 Introduction

817 The spent fuel pool (SFP) provides “*storage space, heat removal and shielding for the spent fuel. The pool, which is contained within [structural module] CA20, is approximately 12.95m deep*” and all portions of the structural module in contact with the water in the pool are stainless steel. (Section 6.4.7.2 of the 2010 PCSR).

818 This section of ONR-GDA-AR-11-002 describes Westinghouse's submittal with respect to the hierarchy of containment provided against potential leakage from the SFP (and adjacent pools) and the methods of leak detection and collection. Design aspects of the CA20 structure, which have been assessed, are described in Section 4.15.5 of this report, e.g. seismic loading, FE analysis, fire resistance.

4.17.2 Documents Submitted

819 The information detailed below has been taken from the following Westinghouse documents:-

- PCSR UKP-GW-GL-793 Draft Revision A, December 2010 (Ref. 1).
- Section 3.8 and Appendix 3H of the European Design Control Document, Revision 1 (Ref. 67).
- APP-GW-C1-001 Civil Structural Design Criteria (Ref. 81).
- Westinghouse response Letter WEC00469N pages 52-55 (Ref. 134).
- Westinghouse response to TQ-AP1000-1218.
- APP-GW-Z0-100, Nuclear Island Structural Modules Specification, November 2009 (Ref. 194).
- APP-CA20-S3C-001 Revision 0, CA20 Connection Design: Module Wall to Module Floor, (Ref. 199).

4.17.3 Containment Requirements

820 Containment structures for spent fuel pools must provide defence in depth as defined by SAP EKP.3 and supporting paragraph 144.

Engineering principles: key principles	Defence in depth	EKP.3
A nuclear facility should be so designed and operated that defence in depth against potentially significant faults or failures is achieved by the provision of several levels of protection.		

"144 An important aspect of the implementation of defence in depth is the provision of multiple, and as far as possible independent, barriers to the release of radioactive substances to the environment, and to ensure the confinement of radioactive substances at specified locations. The number of barriers will depend on the magnitude of the radiological hazard and the consequences of failure."

821 Civil structures that are required to contain spent fuel pools must employ multiple barriers. The numbers of barriers are dependent on the radiological hazard, but the UK Regulator expects in a modern design that at least two barriers would be provided for a spent fuel pool. The minimum barriers required are:

- A primary liner with a leak detection and collection system.
- Secondary containment with its own leak detection system and method of collecting or retaining the leak.

4.17.4 Assessment Aims

822 This assessment has concentrated on the potential for leakage of borated water through the primary liner and into the structural wall behind with respect to two major concerns:

- 1) Possible leakage into the environment, i.e. the ground beneath the base slab.
- 2) Possible leakage into the internal structure of CA20 and the potential for the mild steel structural elements to corrode.

823 The structure of the CA20 module, which forms the spent fuel pool, is a novel design. There is no operational experience of this type of composite construction being used for liquid containment at any station in the world. The construction is also unusual in that the primary liner has a structural function, key to the capacity of the structure and that it is pre-fabricated before being lifted into its final position.

824 My assessment is concerned with minor leaks that result in a steady, albeit very low, flow of borated water into the CA20 structure. This type of fault would have an insignificant effect on the water levels of the pool and the main safety function of keeping spent fuel covered. However, this type of leak would be very difficult to remediate or could go undetected for years during which time the internal structure could be adversely affected.

4.17.5 Description of SFP

4.17.5.1 General Arrangement

825 The spent fuel pool (SFP) is located in the southern part of the Auxiliary Building and is classified as a Class 1 structure. It is one of the cells within a pre-fabricated modular structure, termed CA20.

826 The arrangement of CA20 comprises a rectangular cell structure which is 14.17m by 21.11m on plan. The walls are 20.955m high and extend from the nuclear island foundation raft (basemat) at +89.789m (66'-6") up to a level of +110.744m (135'-3"). APP-CA20-S3C-001 Revision 0 (Ref. 199) includes plans and sections of CA20, and part of these are reproduced in Figure 14 and Figure 15 below.

827 The spent fuel pool is 11.28m by 5.18m in plan internally. The pool base is a suspended slab with floor level at +97.778m (92'-8 1/2") and top of walls at +110.744m (135'-3").

828 The spent fuel pool, the transfer channel and the cask loading pit will all be filled with borated water during operation. Normal operating water level is at +110.439m (134'-3"). Thus the SFP is 12.97m deep, with nominally 0.3m freeboard. The rooms below all three tanks will be dry and accessible during operation.

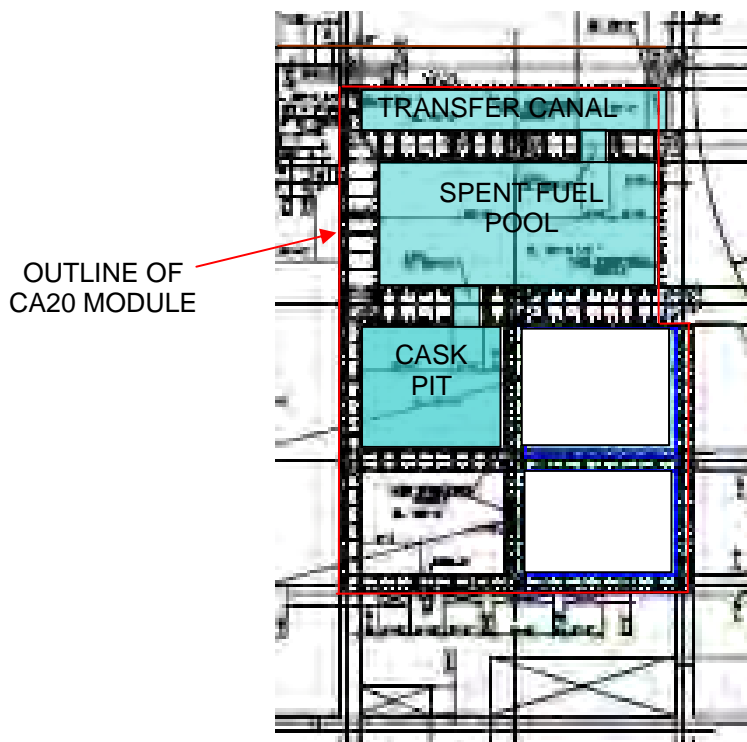

Figure 14: Plan on CA20 Showing Spent Fuel Pool

4.17.5.2 Operation

829 The SFP is linked to the adjacent fuel transfer canal by a gate arrangement to allow transfer of fuel elements from the reactor into storage racks located in the pool. The fuel transfer canal, SFP and cask loading pit contain borated water at a concentration of 2700 ppm (Section 6.4.7.2 of 2010 PCSR, Ref. 1).

- 830 The fuel "is stored in high-density racks, that are freestanding, neither anchored to the pool floor nor braced to the pool wall (Section 21.7.8.1 of 2010 PCSR). The feet of the racks rest directly onto the pool floor liner, via spreader plates.
- 831 The SFP has a cooling system (SFS) which comprises two separate cooling trains (systems of pipework) which draw off water from the SFP using skimmers. The water is then passed through heat exchangers (HX), filters and ion exchangers/demineralisers before being returned to the pool. Under normal operation, one pipe system will cool and purify the SFP, with the other available as backup. The SFS is designed to maintain the water temperature below 48.9°C. The SFS removes contaminants to limit corrosion and maintain cooling water clarity (Sections 21.7.8.4 and 6 of 2010 PCSR).

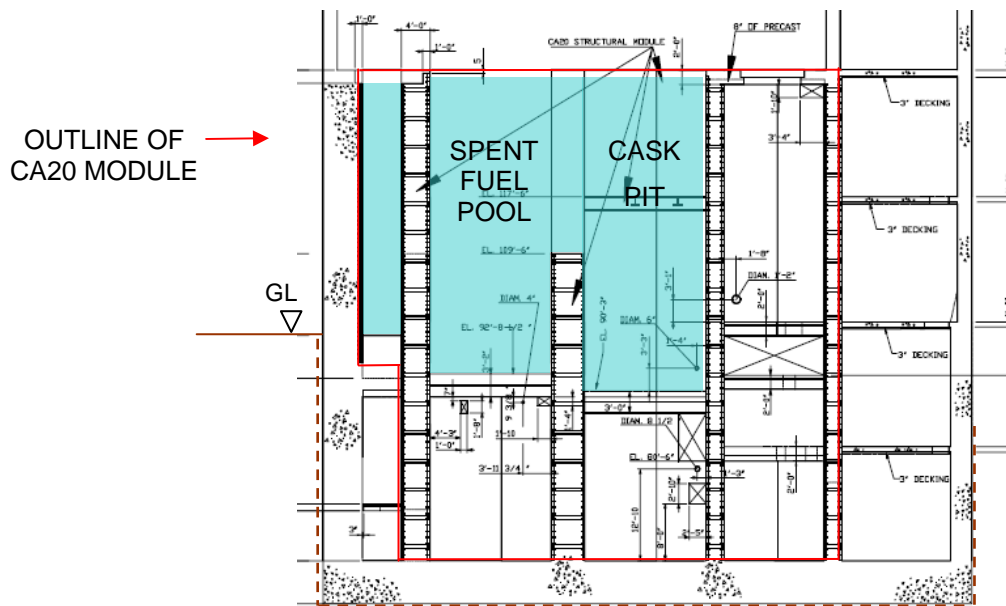

Figure 15: Section Through CA20 Showing Spent Fuel Pool

4.17.5.3 Structural Arrangement

- 832 The CA20 module is constructed from steel/concrete/steel composite sandwich construction as described in Section 4.16.4. Wherever the face plates are in contact with water, duplex stainless steel plate is used, such that the structural plate also acts as the primary liner. All internal structural components are fabricated from mild steel.
- 833 The walls to the west (top of Figure 14) and north (right of Figure 14) are single plates rather than composite construction. These plates are designed as permanent shutters to the RC wall behind, as well as being the primary liner to the water filled cells.
- 834 The west wall to the spent fuel pool, i.e. between it and the transfer canal is identified as a critical section in Appendix 3H.5.5.1 of the EDCD. This notes that "Table 3H.5-8 shows the required plate thickness for certain critical locations. The steel plates are generally half inch thick. The plate thickness is increased close to the bottom of the gate through the wall where the opening results in high local member forces.
- 835 The structural model CA20 is pre-fabricated and lifted into its final position as a whole and then filled with concrete.

4.17.5.4 Design Basis

- 836 The SFP is designated as a Class 1 structure and, as such, is designed to withstand loading arising from the safe shutdown earthquake (SSE) in addition to the normal hydrostatic loading from the retained liquid and thermal stresses, resulting from through wall temperature gradients.
- 837 Loading arising from both operational and fault conditions has been considered (refer to Section 4.15.5 of this report for more details on load cases for CA20).
- 838 Dropped load assessment has been completed on the basis of three hypothetical drop scenarios for a dropped fuel assembly (Section 9.14.5.3 of 2010 PCRSR). The scenarios consider that elements are dropped within fuel racks and loading is transferred to the pool base slab through the small plates located beneath the vertical legs of the racks. The conclusion of this study is that *“the postulated drop event will not breach the SFP floor liner.....therefore it is concluded that a dropped fuel assembly will not cause the spent fuel storage pool to lose containment”*.

4.17.5.5 Containment Provided/Claimed

- 839 The PCRSR Section 26.8.3 describes the containment as *“the design of the AP1000 plant also takes into account prevention of contamination by using secondary containment systems for the AP1000 plant chemical storage tanks [Ref. 26.1, Section 2.9.4, Table 2.9-6]. Some of the plans need to be reviewed during site-specific analysis and designed as necessary to ensure that they will comply with UK guidance [Ref. 26.32]. Prevention of radioactive contamination is also minimised by using system, structure, and component (SSC) designs and operational procedures that limit leakage and/or control the spread of contamination. In this regard, the spent fuel pool and connected pools are examples of structures designed to eliminate unidentified leakage to the groundwater. These are documented more fully in the Environment Report [Ref. 26.1, Section 2.9.5]. Westinghouse prepared a document [Ref. 26.33] to demonstrate that these practices are consistent with the US Nuclear Regulatory Commission (NRC) Regulatory Guide 4.21 [Ref. 26.34], which is considered good practice.”*
- 840 Westinghouse describes the detail of the civil engineering hazard barriers claimed in their response to TQ-AP1000-1218, as follows.
- 841 *“Redundant means of protection and detection are provided against leakage from all pools, including the spent fuel pool, inside the nuclear island that are designed to contain borated water. The pools have liners to prevent borated water from corroding the concrete or structural steel behind the liner. All welds in the liners are also equipped with leak chases at weld locations in the event of a leak in the pool liner. An operator can detect leakage from the spent fuel pool by two diverse means”*. These two means are:
- Pond surface level detectors. Three detectors are provided which would alarm if the pool level drops.
 - The leak chase system drains into collection pots which will alarm.
- 842 The leak chases are fabricated duplex stainless steel channels provided behind each line of weld between pool liner plates. Westinghouse states in its Letter UN WEC00469N (Ref. 134) that *“The leak chases are provided to prevent borated water from getting behind the various pool liner plates and potentially corroding the structural elements*

behind the pool liners.....These leak chases would capture potential leakage from the fuel transfer canal, spent fuel pool, cask loading pit, and the cask washdown pit.”

843 In their response to TQ-AP1000-1218, Westinghouse claims that “for leakage to get between the wall plate and concrete, two leak tight boundaries would have to fail. The primary boundary, the wall plate seam weld, would first have to fail.... However should a leak occur in the primary boundary, it will be contained by the secondary leak chase boundary. Leakage flow into the secondary boundary will be open channel flow with little or no hydrostatic pressure between the secondary weld seam and the concrete, so that even if the secondary weld seam fails, the path of least resistance will be into the channel and on to the collection/detection system and not through the failed secondary weld seam.”

844 Westinghouse concludes that “in the improbable event leakage would somehow manage to get behind both barriers and potentially cause structural damage, structural examinations could be conducted using UT and other advanced NDE methods to determine the extent of the damage and repair as necessary.

”

4.17.6 Assessment

4.17.6.1 Possible Leak Paths and Consequences

845 Once the premise is accepted that pond water could reach the concrete, then my concerns focus on possible leak paths and consequences. The SAP ECE.3 addresses these concerns, and is given below.

Engineering principles: civil engineering	Defects	ECE.3
It should be demonstrated that safety-related structures are sufficiently free of defects so that their safety functions are not compromised, that identified defects are tolerable, and that the existence of defects that could compromise their safety function can be established through their life-cycle.		

846 Borated water will corrode mild steel. Although the corrosion rate is quicker at temperatures higher than the normal pond operating temperature, significant corrosion could occur from a steady leak which remains undetected over a long period of time. My concern is that the mild steel component of the structural module could be corroded, resulting in the wall and floor slab capacities being reduced.

847 I postulate that the most vulnerable structure is the pond base slab, since this relies on mild steel reinforcement bars in the top of the slab, which continue into the wall via couplers. The slab soffit comprises mild steel plate and T sections. Leakage through the base liner would very quickly reach the rebar and could travel down the wall plate to the soffit. Potential corrosion behind the plate would not be detectable by visual inspection. Structural integrity at the edges of the slab would be severely affected and could lead to collapse of the pool base.

4.17.6.2 Liner Integrity

- 848 Leakage through the primary plate could happen through the plate itself, or through the line of welds joining plates together. The former would not be collected by the leak chase system. I accept that a defect in the plate should be practically eliminated by modern factory production methods; however a single liner does not provide defence in depth.
- 849 Potential leakage through the leak chases could occur if there was a gross defect in the welds. Since water within the chase would not be under pressure, it is not likely to penetrate into potential minor cracking in the continuous welds. However, since installing the leak chases on site requires welding to be carried out in awkward locations with restrictive access, achieving the required workmanship for high integrity welds will be more involved. I am most concerned about the horizontal welds and leak chases. Even if the leak chase is laid to a suitable fall, a steady leak through the primary weld may eventually encounter a gross defect in the secondary welds if present.
- 850 I also consider there is vulnerability at the welds between leak chases and collection pipes and with the collection pipes themselves, since the collection pipes are also embedded in the concrete structure. Any penetrations/cracks in these welds or pipes would provide direct a leak path to the concrete. No sleeves are provided to the piping.

4.17.6.3 Dropped Loads

- 851 The argument put forward by Westinghouse is that their dropped load analysis shows the pond base liner will not be damaged by the design basis dropped loads.
- 852 I have not carried out a detailed assessment of the dropped load analysis. However, I note that the Internal Hazards assessor has raised a GDA Issue on dropped loads and impacts, **GI-AP1000-IH-06** (Ref. 57). If resolution of this GI results in a change to the dropped loads analysis for the SFP, then this could affect my assessment of civil structures.

4.17.6.4 Repair of Leaks

- 853 Repair of a primary leak is not straightforward. The density of fuel stacking is high, with no provision for movement of fuel out of the pool to allow drain down and repair in the event of leakage. Therefore, an operator is more likely to attempt to make a safety case by hypothesizing on the potential damage to the structure from the leak and how this affects the structure's capacity over the remaining lifetime.
- 854 It is not clear to what extent potential leaks can be isolated. No information has been submitted as to what operator action is taken when collection pots alarm. For example, if a small amount of flow is detected, is this just logged or is a positive investigation carried out?

4.17.7 Summary and Findings

- 855 My concerns centre about the fact that Westinghouse is relying on a single liner. The claim that the leak chases act as secondary containment is not accepted; these chases are for the detection and collection of pond water in the event of the primary liner welds failing. I consider it possible that defects could be present in both a primary liner weld and a leak chase weld, which could lead to water ingress to the concrete.

- 856 The minimum defence in depth for spent fuel pools is to provide two containment barriers, each with their own leak detection system. I do not accept that this has been provided in the AP1000 design.
- 857 There is potential for long term leakage into the CA20 structure, compounded by the fact that repairs to the liner are not practicable, without major disruption to operation. This long term leakage could cause internal corrosion of the CA20 structure, which would be very difficult to detect, quantify and then prove that the structure could continue to meet its safety functional requirements. Ultimately, this long term leakage could migrate through the base slab to the formation.
- 858 GDA Issue **GI-AP1000-CE.04** (Ref. 66) has been raised to require Westinghouse to carry out an engineering optioneering study of the details for CA20 to ensure that secondary containment, with its own separate leak detection and collection system, is provided. The option should be selected using ALARP principles and should satisfy the following:
- Provide secondary collection such that the potential for leakage through the base slab is minimised.
 - Give positive notice that leakage through the structure was/was not occurring, with appropriate monitoring and measurement.
 - Justify that the integrity of the structure will be maintained throughout the lifecycle.
- 859 To substantiate the claim that the primary welds and the leak chase welds are high integrity, further documentation will be required on the weld materials, procedures and testing. This is captured in the Assessment Finding below, which must be addressed prior to milestone 1 – long lead item procurement.

AF-AP1000-CE-56 Spent Fuel Pool - The licensee shall substantiate the primary welds and the leak chase welds are high integrity. Evidence shall be submitted for specifications for weld materials and procedures. This should include quality control on materials on site, e.g. ensuring correct weld rods are used by operators, especially considering mild and stainless steel are in close proximity and testing for high integrity welds i) post fabrication and ii) post erection of CA20.

4.18 Turbine Building

4.18.1 Assessment

- 860 The assessment of the Turbine Building has focused on the split classification between the first bay and the main area of the building. The first bay is a concrete, seismic C-II building and part of the generic design. The main area comprises a steel, seismic class NNS structure (refer to Section 4.2.2). It should be noted that the main area will be redesigned at site specific phase since the UK uses 50Hz turbines, which are larger than the US 60Hz turbines and so the building footprint will need to be bigger (refer to Westinghouse response to TQ-AP1000-799).
- 861 I also sought confirmation that the C-II first bay of the building would not collapse onto the C-I nuclear island during the nuclear safety case design basis events, either due to its own action or resulting from the collapse of the NNS main area onto it. Three technical queries were raised on this TQ-AP1000-680, 794 and 944 as described in Section 4.3.1.1.
- 862 The responses to TQ-AP1000-680 and 794 were incorrect and this was clarified by TQ944 which confirmed that C-II structures are designed to nuclear codes and

constructed to non-nuclear codes. The structures are analysed for the seismic, wind and tornado loading scenarios using the same code requirements as seismic Category I structures; that is nuclear code standards. Therefore, a deep sample of design documentation was also undertaken to confirm if this claim had been carried through in the design (Ref. 27).

863 Additional documentation, specific to the Turbine Building, was requested via TQ-AP1000-799 and during a technical meeting on 13 January 2011. Documents reviewed were as follows:

- APP-2000-S2C-001 Revision 1 AP1000 Turbine Building Design Calculation: Seismic Response Analysis (Ref. 200).
- APP-2000-S3C-001 Revision 1 AP1000 Turbine Building Design Calculation: Turbine Building Material Properties and Basic Load Combinations (Ref. 201).
- APP-2000-S3C-002 Revision 1 Turbine Building Design Calculation: Turbine Building Wind and Tornado Loads (Ref. 202).
- APP-2100-S2C-001 Revision 0, AP1000 Turbine Building Design Calculation: First Bay (Part 1: Static Analysis and Seismic Response Analysis) (Ref. 203).
- APP-2100-S3C-001 Revision 1, AP1000 Turbine Building Design Calculation: First Bay (Part 2: Section Design) (Ref. 204).
- APP-2000-S1C-002 Revision 0, Turbine Building UBC 1997 Response Spectra, (Ref. 205).
- APP-2000-SSC-001 Revision 1, Turbine Building Design Calculations – Steel Frame Structures (Ref. 206).

4.18.2 Loads and Load Combinations

864 The assessment of the application of the external hazards load schedule considered each part of the Turbine Building separately (Ref. 27).

865 The first bay is subject to the load combinations for C-II structures outlined in Tables 5 and 6 of the Civil/Structural Design Criteria (Ref. 81). Since Ref. 81 is a site wide document, the assessment looked at the specific documents for the first bay to check if there were any differences. Twelve load combinations for the First Bay are outlined in Section 4.6 of Ref. 204 and these are based on the nuclear code, ACI 349-01. It is shown in Ref. 204 that the effect of the tornado load is significantly less than that for the seismic event and accidental pressure load.

866 The steel structure of the main area is classified as seismic class NNS and is therefore subject to the load combinations outlined in Tables 7 and 8 of Ref. 81. Twelve load combinations for the main area are outlined in Section 5.0 of Ref. 201 and these are based on the load combinations detailed in ASCE 7-98 (Ref. 91) in conjunction with the stress limit coefficients listed for the AISC-S335 (Ref. 207) allowable stress design method. Ref. 202 outlines the wind and tornado loading and Ref. 205 develops the seismic response spectra based on 1997 UBC (Ref. 90). The governing loadcase is the seismic event resulting in demand equal to three times the magnitude of the imposed wind loading.

4.18.3 Seismic Isolation

4.18.3.1 Assessment

867 The seismic design methodology for providing seismic isolation gaps between buildings, to prevent impacts between them, is discussed in Section 4.10.8. This section details the deep sample undertaken to confirm if the seismic methodology had been carried through correctly within the calculations.

868 Westinghouse has provided a gap between the following structures:

- 1) The first bay and the Auxiliary Building superstructures and foundations (founded separately).
- 2) The first bay and main area superstructures (founded on the same raft foundation).

4.18.3.2 Gap 1 - Between First Bay and Auxiliary Building

869 The minimum size of the required isolation gap between the C-I Auxiliary Building and the Turbine Building C-II first bay, has been calculated by Westinghouse using 2D SASSI analysis. This is described and assessed in Section 4.10.8.

870 The deep sample carried out was supported by ABSC (Ref. 27) identified the following displacements that need to be considered:

- Relative motion between the foundations = 11.3mm (0.446") as shown in Table 13 of this report.
- Structural deformation of the NI. Table 5.4 of Ref. 137 gives 3.4mm (0.134") as the maximum.
- Structural deformation of the first bay. Figure A.5-6 of Ref. 206 gives 24.6mm (0.97").
- Gap closure due to foundation rocking. This was not identified in the Westinghouse reports since its analyses were based on hard rock/fixed base. However, an estimate was made by ABSC using the maximum value in Table 13, of 36.4mm (1.434").

871 The above gives an absolute sum of: $11.3 + 3.4 + 24.6 + 36.4 = 75.7\text{mm}$ (3 inches). The Westinghouse methodology requires the gap to be the minimum of double the calculated gap or 4 inches (refer to Section 4.10.8.1) Doubling this gives 6 inches which is less than the 12 inches provided.

4.18.3.3 Gap 2 – Between C-II and NNS parts of Turbine Building

872 The gap required between the first bay and the main area is given in Figure A.5-6 of Ref. 206 as follows:

Total gap required	=	elastic displacement	+	equivalent elastic drift
N-S direction		of first bay		of main area
	=	0.97"	+	7.28"
	=	8.25"		
Gap provided	=	10" > 8.25"		

- 873 The criteria stated in the Civil/Structural Design Criteria (refer to Section 4.10.8.1) is NOT adhered to. If twice the absolute sum of maximum displacements was used, this would require a gap of $2*(0.97 + 7.28) = 16.5''$.
- 874 The calculation of 0.97'' was not sampled in detail. However, the calculation of 7.28'' for the main area was looked at since any error in this is likely to have more effect on the overall gap. The roof of the first bay is at elevation 169'-0'' and the roof of the main area is at 225'-3''. Therefore, the displacement of the main area is calculated at 170'-0'' to be comparable.
- 875 Westinghouse carried out two separate seismic analyses to calculate the maximum predicted displacement as follows:
- An elastic assessment (Ref. 206) performed using the UBC approach results in the displacement at 170'-0'' of the steel structure = 6.82''.
 - Dynamic analysis using reduced elastic stiffness approach. This simplifies the elastic and inelastic structure response into a single response by reducing the structural frame stiffness to 20% of elastic stiffness (Section A.5.1 of Ref. 206). This gives a displacement at 170'-0'' of the steel structure = 7.28''.
- 876 Since the second analysis gives the worst case, this value is used.

4.18.4 Findings

- 877 The detailed design of the Turbine Building will be carried out at site specific phase since the building dimensions will change to suit UK turbines, which are bigger than US turbines.
- 878 The classification of the two parts of the Turbine Building is appropriate.
- 879 I conclude that the appropriate external hazards have been included in the design of the two different parts of the building. Site specific external hazards will be considered during Phase 2 as discussed in Section 4.4.7.
- 880 The calculation of seismic isolation gaps has been carried out satisfactorily but the analysis will have to be repeated for the site specific soil strata where the relative motion between foundations, including rocking, is likely to be higher than for a hard rock site. This is captured in the Assessment Findings in Section 4.10.

4.19 Annex Building

4.19.1 Assessment

- 881 The classification and categorisation of the Annex Building has been assessed and found to be acceptable (refer to Section 4.3). This is C-II for the taller part of the building adjacent to the nuclear island and NNS for the single storey part away from the nuclear island.
- 882 The review of external hazards and design codes and standards for C-II and NNS buildings has been assessed and found to be acceptable (refer to Section 4.3).
- 883 The design methodology used for assessing the seismic isolation required between the Annex Building and the Auxiliary Building, is similar to that used for the Turbine Building.

Since the latter has been sampled in detail, this is sufficient to test the methodology for the Annex Building.

4.19.2 Findings

884 The Annex Building has not been sampled in detail in my Step 4 assessment. This is because sufficient sampling has been carried out on other buildings to adequately assess Westinghouse's design methodologies.

4.20 Diesel Generator Building

4.20.1 Assessment

885 The classification and categorisation of the Diesel Generator Building has been assessed and found to be acceptable (refer to Section 4.3). This is NNS since the building is away from the nuclear island and there is no possibility of interaction with any C-I structures.

886 The two generators are both housed in the same building, separated by a wall claimed to be a 3 hour fire barrier, to prevent a fire on one diesel affecting the second. The vulnerability of the Diesel Generator Building to a single extreme external hazard was questioned in the Step 3 Assessment Report (Ref. 20).

887 A Regulatory Observation, RO-AP1000-075, was raised by the Inspector for the electrical systems topic requesting that consideration be given to locating the two standby diesel generators in separate buildings. This RO was raised as a cross-cutting issue in conjunction with internal hazards and external hazards assessments. The RO states that the regulatory expectations, in respect of segregation of safety related systems, are set out in Safety Assessment Principles ELO.4 and paragraph 206, ESS.18 and paragraph 352 and in EDR.2 and paragraphs 168, 174 and 233.

888 The Westinghouse response claims that "*segregating the onsite standby diesel generators into different buildings that are sufficiently spaced apart or located on either side of the nuclear island is unnecessary. The added protection provided by separating the onsite standby diesel generators is not required due to the level of protection, diversity, and segregation that is provided by the existing [electrical] design.*" Therefore, the essential safety systems can be maintained on loss of both standby diesels.

889 The review of external hazards and design codes and standards for NNS buildings has been assessed and found to be acceptable (refer to Section 4.3).

4.20.2 Findings

890 The claim made in response to RO-AP1000-075 has been assessed in the Step 4 Electrical Systems Assessment Report, ONR-GDA-AR-11-007, Ref. 42, and has resulted in GDA Issue **GI-AP1000-EE-01** (Ref. 58). This requires Westinghouse to substantiate that electrical supply required for the safety case can still be supplied in the event that both diesel generators are lost.

891 I did not carry out any detailed sampling of the structure or foundation design for the Diesel Generator Building. However, provided the claim above is justified under the GDA issue, I do not believe a detailed review is required.

4.21 Radwaste Building

892 The Radwaste Building has been taken out of scope of GDA due to future modifications to the building layout to provide the facilities required on a UK site. Therefore, no assessment has been undertaken, and this will need to be done at site specific stage.

4.22 Sample of Seismic Margins and Fragilities**4.22.1 Scope of Assessment**

893 A review of seismic fragilities of civil structures was undertaken, which feeds into the probabilistic safety analysis assessment (Report ONR-GDA-AR-11-003, Ref 37). To give some focus to the sampling, it was decided to examine the main building structures affecting in-containment plant and those items for which seismic failure was predicted, to show a large contribution to the overall probability of failure across a range of initiating events.

894 Westinghouse has carried out a seismic margin assessment (SMA) for the AP1000 PSA (probability safety assessment). The seismic fragility of a structure is measured by the High Confidence of Low Probability of Failure (HCLPF) calculations. The HCLPF values are calculated for individual structures, systems and components and then these are input to the SMA which determines the HCLPF for the whole site.

895 The AP1000 calculations for seismic fragilities are presented in APP-PRA-GSR-002, AP1000 Seismic Margin HCLPF Calculations (Ref. 208). Four calculations are presented as follows:

- Shield Building SC cylindrical wall.
- Shield Building RC cylindrical wall.
- Containment interior structure – SC modules.
- IRWST tank.

896 I note that Westinghouse has listed two open items in the calculations with respect to the PCS Tank and the Shield Building fragility calculations, which mean these HCLPF calculations are reliant on other work being completed.

4.22.2 Assessment**4.22.2.1 Methodologies**

897 The HCLPF values calculated by Westinghouse in Ref. 208 are shown in Table 23 below:

Table 23
HCLPF Values Calculated by Westinghouse

Structure Sampled	Methodology	HCLPF
Steel Containment Vessel Reactor Pressure Vessel Supports	Probabilistic fragility analysis	0.71 pga
Shield Building Steel Composite	Conservative deterministic failure	0.74g pga

Table 23
HCLPF Values Calculated by Westinghouse

Structure Sampled	Methodology	HCLPF
(SC) Cylindrical Wall	margin (CDFM) method	
Shield Building Reinforced Concrete (RC) Cylindrical Wall	Conservative deterministic failure margin (CDFM) method	0.67g pga
Containment Interior Structure (SC) and IRWST Tank	Deterministic approach	0.71g pga

898 In conformance with US NRC requirements, Westinghouse has chosen a seismic margin earthquake of 1.67 times the Certified Seismic Design Response Spectrum used as the Safe Shutdown Earthquake, thereby defining the seismic margin earthquake at 0.5g pga. Therefore target HCLPF values are set at 0.5pga. The calculations are stated to be applicable to all AP1000 plants. The seismic event is assumed to occur when the plant is at full-power.

899 A number of methodologies have been utilised by Westinghouse to determine the HCLPF values. These include probabilistic fragility analysis, conservative deterministic failure margin (CDFM) method, test results, deterministic approach and the use of generic fragility data.

4.22.2.2 ESB SC Cylindrical Wall

900 In the HCLPF calculation for the Shield Building SC wall, Westinghouse conservatively assumes that it carries half of the seismic demand of the whole nuclear island. The value of 0.74g is based on the ratio of the demand principal tensile stress in the plate, compared with the minimum specified yield strength of 50ksi. A ductility factor of 1.25 is applied to the minimum yield strength, which implies the plates will be stressed to 1.25 times this strength. TQ-AP1000-1072 queried whether the shear connectors for the SC wall could develop these high stresses. Westinghouse's response was that its test program, undertaken for the Shield Building, benchmarks the capacities of the various shear connectors. It refers to the ESB Design Report (Ref. 72).

901 No assessment against a shear stress failure criterion is undertaken for pure shear. This was queried via TQ-AP1000-1070. Westinghouse's response was that the SC structure has equal or greater shear strength than the RC structure and since shear was considered for the latter, this bounds the SC structure. This response is acceptable.

4.22.2.3 ESB RC Cylindrical Wall

902 This calculation is presented in Section 6.1.2 in Ref. 208. In particular, the HCLPF value of tangential shear failure at the elevation 100' in Section 6.1.2.1 has been selected for detailed review. The HCLPF value is calculated to be 0.67g pga.

903 My assessment queried the derivation of the factor of safety on shear strength (Ref. 25) and TQ-AP1000-1069 was raised. Westinghouse's response was that since there was zero non-seismic shear load, then the compressive (-ve) dead load appears as a positive term in the factor of safety equation.

904 The confidence level at which the seismic demand is viewed is different between the conservative deterministic failure margin (CDFM) method and the probabilistic fragility method. The RC cylindrical wall was claimed to be to the CDFM but it was unclear which confidence level had been used. Therefore, TQ-AP1000-728 was raised and subsequently TQ-AP1000-1075. Westinghouse's derivation of the fragilities is compatible with the maximum horizontal direction being enveloped by the site specific design spectrum, rather than the mean of the two horizontal directions. Westinghouse's response was still not specific as to whether the site-specific uniform hazard spectrum (UHS) will be, or needs to be, the maximum of two horizontal directions, or the geometric mean.

4.22.2.4 CIS and IRWST Tank

905 This calculation is presented in Section 6.1.5 in Ref. 208. The deterministic method has been used and the HCLPF value for ductile failure of the steel plates is calculated to be 0.71g pga. This is calculated by comparing the required plate thickness with the actual plate thickness provided for various CIS modules. The lowest margin is shown to be 1.9.

906 It is apparent that both in-plane and out-of-plane strength checks have been considered. However, the deterministic method is simplistic in that the calculation of the HCLPF value is not dependent on the failure mode.

907 TQ-AP1000-1072 applies equally to the CIS plates, i.e. querying whether the plate anchorages can actually develop the high stresses required for the plate to be the component that fails. If they cannot, then a different failure mechanism and hence a different HCLPF value would result.

4.22.3 Summary and Findings

4.22.3.1 Methodologies

908 Provided the approach adopted by Westinghouse demonstrates a seismic margin compatible with its target of 0.5g pga, the approach is acceptable, even if it contains conservatism. Westinghouse's intention is not to derive realistic fragilities for use in a seismic PSA but to demonstrate that this target has been met in a seismic margins assessment.

909 Horizontal peak ground acceleration is the parameter adopted by Westinghouse for this work and this is considered to be acceptable. The methodologies adopted for the HCLPF calculations are also considered acceptable.

4.22.3.2 ESB SC Cylindrical Wall

910 Specifically for the HCLPF calculation for the SC cylindrical wall, the response to TQ-AP1000-1072 is not acceptable. The tests undertaken did not demonstrate that the anchorage of the steel plates permits yielding of the steel plates at their point of anchorage. The ESB Design Report also states that the design of the anchorage rebar is based on results from building model FE analysis, not on the thickness of steel plate actually provided (Section 4.2.1). If the margin on the tie bars is the governing factor rather than the plate strength, then the HCLPF value could reduce below the 0.74g pga claimed. Therefore, this needs to be included in the final calculation at site specific stage. An Assessment Finding is raised as follows which must be addressed prior to milestone 1

– long lead item procurement. This finding may be influenced by the outcome of the response to **GI-AP1000-CE-02.A1** on the tie bar material.

AF-AP1000-CE-57: *The licensee shall include in the site specific HCLPF calculation for the Shield Building SC cylindrical wall, an assessment of the different failure modes including tie bar failure, rather than basing the calculation on plate tensile strength alone.*

4.22.3.3 ESB RC Cylindrical Wall

911 The overall methodology is considered acceptable for this calculation. No credit is taken for the 'conservative estimate of median damping' allowed in the CDFM method and this is considered an acceptable approach.

912 The response to TQ-AP1000-1069 is considered acceptable. However, the responses to TQ-AP1000-728 and 1075 are not. This leads to the following Assessment Finding, which must be addressed prior to milestone 3 – NI safety related concrete.

AF-AP1000-CE-58: *The licensee shall justify that the site-specific horizontal Uniform Hazard Spectra (UHS), based on or corrected to be the maximum of two horizontal directions (as opposed to the geometric mean), envelopes the 0.3g pga design spectrum used in the generic design. Similarly, the site-specific vertical UHS must be shown to envelope the 0.3g pga design spectrum used in the vertical direction.*

4.22.3.4 CIS and IRWST Tank

913 Similarly to the ESB SC cylindrical wall, the calculation of the HCLPF is based on one failure mechanism, which has not been proven to be the critical one. Therefore, the following Assessment Finding is raised, which must be addressed prior to milestone 1 – long lead item procurement.

AF-AP1000-CE-59 *The HCLPF calculation for the in-containment SC modules considers only failure of the plates in tension. The licensee shall include in the site specific HCLPF calculation for the SC modules, an assessment of the different failure modes of the structures to find the critical failure mode and hence the true HCLPF value for these structures.*

4.23 Quality Assurance of Civil Design

4.23.1 Scope of Assessment

914 The detailed ONR assessment on Management of Safety and Quality Assurance is documented in GDA Step 4 Assessment Report ONR-GDA-AR-11-013, Ref. 48. This section is purely for the assessment of control of civil engineering sub-consultants.

915 The GDA Step 3 assessment report (Ref. 20) included, in the conclusions, a concern about the control of civil/structural design work. Westinghouse utilises other design companies, either as design partners or as sub-consultants. ONR's concern was with respect to the quality assurance of the issue of information to/from these companies and how the work carried out by them was verified by Westinghouse. This was specifically relevant to the design of the CA Modules where there did not seem to be a readily available design methodology document, which would have been used to instruct the designers.

- 916 This part of my assessment was supported by ABSC, who carried out a detailed review of the QA procedures and their implementation (Ref. 26). The review comprised the following:
- Document review.
 - Deep sampling audit of Westinghouse civil design – 16 September 2010.
 - Deep sample of two design change proposals; one being a completed Class 2. change, the other being a Class 1 which is still open.
 - Sub-contractor audit of Ansaldo – 9 December 2009.
 - Sub-contractor audit of INITEC – 11 December 2009.
- 917 The scope of the review covered by this ABSC report assesses the quality management of suppliers, the electronic document management and retention systems in place, the control of documentation and samples the process of engineering design changes to formally issued documents through a deep sample exercise.
- 918 The following supporting documents were initially identified for reference and review during the audit trail.
- “AP1000 European Design Control Document” (EDCD). Westinghouse. EPS-GW-GL-700 Revision 0 (Ref. 67).
 - “Westinghouse Level II Policies and Procedures” Westinghouse. E6-Quality Revision N/A, March 2010 (Ref. 209).
 - Design Change Proposal “Thickening of Faceplates at Top of CA01 Module”. Westinghouse APP-GW-GEE-582 Revision 0 (Ref. 210).
 - Design Change Proposal “MSIV Compartment Structural Design Changes”. Westinghouse. APP-GW-GEE-2081 Revision 0 (Ref. 211).
- 919 Due to the potential for revision of the Westinghouse documentation, the above documents were considered as frozen for this review.

4.23.2 Westinghouse Quality Management System

- 920 The Westinghouse Level II Policy and Procedure document (Ref. 209) details the Quality Management procedures and policies employed by Westinghouse and the expectations placed on the external organisations supplying services. The specifics of the Westinghouse Quality Management System have been reviewed in assessment report ONR-GDA-AR-11-013, Ref. 48. Therefore, this section is limited to a high level review.
- 921 Chapter 17 of the EDCD outlines the QA program applicable to the “*design, procurement, fabrication, inspection, and/or testing of items and services for the AP1000 Project.*” This is in accordance to US standards and is claimed to be more stringent than the requirements of BS EN ISO 9001 (Ref. 212).
- 922 Westinghouse has procedures for ensuring its personnel are suitably qualified and experienced. These procedures define the roles and responsibilities of the responsible manager, the design engineer, reviewer, applicability reviewer, verifier, project manager, auditor and lead auditor. The responsible manager is “*responsible for: 1) ensuring that designers and verifiers have the appropriate qualifications for performing or verifying the design analysis to which they are assigned, 2) approving the design analysis, and 3)*

confirming acceptability of verification method and comment resolution.” (Procedure NSNP 3.2.6 of Westinghouse QA procedures Ref. 209).

923 It should be noted that Westinghouse does not hold registers of Suitably Qualified and Experienced Personnel (SQEP) which are common in the UK Civil Nuclear industry. Westinghouse is aware of the limitations of its existing training and qualification arrangements and is currently implementing improved training requirements, along with introducing a matrix to identify and record the completion of procedural training.

4.23.3 External Organisations

924 Westinghouse has a number of external organisations involved with the civil engineering design of the AP1000 plant. There are generally two levels of partnership: the qualified supplier and the design partner.

925 Qualified suppliers are those organisations whose own QA procedures have been reviewed for adequacy by Westinghouse. Once this is verified, the organisation is placed on the Qualified Suppliers List (QSL). Qualified Suppliers are audited on a three yearly cycle, when their QSL status is renewed. In addition, a yearly assessment is made to ensure Westinghouse holds current information on the supplier. Any concerns with the external organisations' work are raised using a Supplier Corrective Action Report (SCAR) which are tracked and maintained by the QA department. The receipt of several similar SCARs for the external organisation may trigger an interim audit. Qualified Supplier work schedules are managed through a Purchase Order and a Work Authorisation Form (WAF). Any work submitted by a Qualified Supplier must be independently verified by a Westinghouse engineer.

926 A Design Partner is an external organisation which has an enhanced QSL status and is normally a long-standing external organisation. This relationship is managed using a formal interface agreement and there will be a named individual who has Westinghouse authority to sign-off work performed by the partner. Once the Design Partner's representative has approved a document, the receiving Westinghouse engineer accepts the document without additional independent verification being performed.

927 The list of external organisations was confirmed in the response to TQ-AP1000-821. An additional query, TQ-AP1000-1003, was raised questioning the qualification status of the external organisations and their limits of supply. Table 24 below outlines the response to TQ-AP1000-1003.

Table 24:

Westinghouse External Organisations: Scope of Supply and Status

Supplier	QSL Scope of Supply: Service (unless noted)	Qualification Expires:
Ansaldo Nucleaire S.p.A, Genoa, Italy	Product: Civil Engineering & Piping Analysis Service: Engineering Services	30 June 2012
Obayashi Corporation - Nuclear Facilities Division,	Engineering Services - AP1000 Project	31 March 2013

Table 24:
Westinghouse External Organisations: Scope of Supply and Status

Supplier	QSL Scope of Supply: Service (unless noted)	Qualification Expires:
Tokyo, Japan		
KOPEC - Korea Power Engineering Company, Ltd. (AE), Yongin-siGyeonggido, Korea	Engineering design and analysis services	31 January 2012
INITEC – Part of Westinghouse	Engineering Services – AP1000 Project specific to the Auxiliary Building; Drafting, Detailing, Design Implementation.	Next internal audit.
Shaw Nuclear Services, Inc, Stoughton, MA	Engineering, Inspection and Auditing Services	31 January 2011
Toshiba – IEC, Yokohama, Japan	ASME & S/R Design, Analysis and Procurement Activities, including Field Services Processes and Equipment; Provision of Auditing and Inspection Services; Provision of Commercial Products	31 March 2010

928 Ansaldo Nucleaire is a Design Partner of Westinghouse Electric Company LLC and, as such, all work is contracted under a WEC-Ansaldo interface agreement. The ABSC audit carried out a deep sample for the civil engineering design work carried out by Ansaldo. The following documents were inspected at the audit meeting in September 2010:

- Ansaldo project plan.
- WAF from Westinghouse to Ansaldo.
- Document Submittal Form (DSF) from Ansaldo to Westinghouse.

929 This sample was satisfactory and was taken to confirm the correct implementation of the Westinghouse procedures for instructing civil design work and reviewing the output.

4.23.4 Design Change

930 Where a change to the AP1000 design is required, Westinghouse has in place two methods of implementing change; either using a Design Change Proposal (DCP) or an Engineering and Design Coordination Report (E&DCR). A DCP is raised to capture changes to the AP1000 fleet design. The initiator of a DCP must classify the change as either Class 1, 2 or 3. The E&DCR allows changes to the local AP1000 plant to be made during the construction phase. E&DCRs that affect the AP1000 fleet trigger the requirement for a DCP.

931 The three classes of design changes are as follows:

- Class 1 directly affects EDCD and requires change control board (CCB) approval.
- Class 2 does not impact the EDCD and requires only the CCB chairman's approval
- Class 3 change only affects the immediate responsible manager's work and requires only his approval.

932 Two DCPs were reviewed by ABSC as follows:

- Design Change Proposal "Thickening of Faceplates at Top of CA01 Module". WEC. APP-GW-GEE-582 Revision 0 (Ref. 210). This is a Class 2 DCP and is complete.
- Design Change Proposal "MSIV Compartment Structural Design Changes". WEC. APP-GW-GEE-2081 Revision 0 (Ref. 211). This is a Class 1 DCP and is ongoing.

933 APP-GW-GEE-582 was initiated by Ansaldo following analysis of the CA01 module which was carried out by them. The DCP requested the steel liner plates at the top of the CA01 module be thickened to resist the localised loads caused by the placement of the main steam line. Audit of two drawings affected, demonstrated that the change had been made and reference the DCP correctly.

934 APP-GW-GEE-2081 was initiated by Obayashi following their analysis of pipe rupture within the main steam isolation valve sub-compartment in the Auxiliary Building. It was determined that the post rupture internal pressure within the structure reached a peak of 8psi. This value is above the AP1000 fleet generic design pressure limit of 6psi for this area, as defined in the Civil/Structural Design Criteria document (Ref. 81). Due to its possible effect on the Auxiliary Building structure, this DCP was designated Class 1. Resolution of this DCP was ongoing at the time of the ABSC audit.

4.23.5 Sub-Contractor Audits

935 Subcontractor audits were performed at the end of the Step 3 assessment. These were carried out by ONR, assisted by Arup. The subcontractors audited were:

- Ansaldo Nucleaire at their Genoa site on the 9 December 2009.
- INITEC at their Madrid site on the 11 December 2009

936 The aims of these audits were to review the following items. Generally, this was achieved, although some items were not completely explored, due to deviations to allow investigation of alternate routes that became evident during the course of the audit.

- Description of scope of work by the contractor.
- Inspection of the Quality Plan.
- Inspection of findings of previous audits and closure of any corrective actions.
- Inspection of Westinghouse procedures/instructions.
- Inspection of contractor's procedures.
- Inspection of CVs of staff.

937 Ansaldo are responsible for the following design areas:

- Containment Internal Structures (CA01, CA02, CA03, CA04 and CA05).
 - Shield Building roof.
 - Steel frames.
 - Operating floors.
-

- 938 The audit carried out on Ansaldo found that its quality procedures had been satisfactorily followed during detailed civil engineering design work. The only observation was that two superseded documents were not marked as superseded but were kept on file. However, these documents were not directly relevant to Ansaldo's work and so this is not a major concern.
- 939 INITEC is now owned by Westinghouse. INITEC are responsible for the structural design of the Auxiliary Building of the AP100 plant and also generate the detailed structural drawings. Initially INITEC covered all six areas of the Auxiliary Building design, but the Korea Power Engineering Company, Ltd (KOPEC) are now responsible for Areas 1 and 2, the structural steel and reinforcement. In addition, Obayashi are tasked with performing the design calculations specifically for the CA01 module and Shaw are tasked with other areas such as the HVAC.
- 940 All INITEC work is performed to the requirements of the Westinghouse Quality Management System and INITEC does not have its own separate work procedures.
- 941 Generally, the audit carried out by ONR on INITEC found that its quality procedures had been satisfactorily followed during detailed civil engineering design work. The only observation was that no formal minutes had been made of the design review that was audited and INITEC do not record all design reviews.

4.23.6 Findings

- 942 I am broadly satisfied that the audits of Westinghouse and two of its sub-consultants, Ansaldo Nucleaire and INITEC, have demonstrated that the control of external organisations for the civil works design has been carried out in accordance with Westinghouse Policies and Procedures. However, ONR assessment report ONR-GDA-AR-11-013 (Ref. 48) should be consulted for the in-depth review of these procedures.
- 943 The audits of Ansaldo Nucleaire and INITEC performed in 2009, flagged only minor non-compliances. Both companies are design partners of Westinghouse, with enhanced QSL status and operate using the Westinghouse QMS according to the requirements of the Westinghouse Level II Policies and Procedures.
- 944 The design change control procedure has been used satisfactorily for the two specific design changes considered for civil structures. However, future control of design changes requires further substantiation under GDA Issue **GI-AP1000-CC-02** (Ref. 61).

4.24 Construction Verification

- 945 The GDA Step 3 report (Ref. 20) identified that the AP1000 PCSR did not contain sufficient detail on construction verification. This was to be investigated further during Step 4.
- 946 Westinghouse maintains that the detail of the construction specifications and method statements will not be developed until the contractors are appointed and so regard this as the responsibility of the Licensee.
- 947 My assessment has considered the following construction processes and these are reported in the preceding sections:

- Codes used for the construction quality control and quality assurance for Class I, Class II and NNS structures (refer to Section 4.3.1).
- Control of materials including material substitution by contractors (refer to Section 4.7).
- The effects of a quasi metric approach rather than a metric approach which is more familiar to local UK contractors (refer to Section 4.8).
- Backfilling around the NI foundation and settlement during construction have an effect on the design and so specifications of these need to be closely controlled by the designers (refer to Section 4.11).
- Final construction details between the containment steel vessel and the concrete structures (refer to Section 4.12.2).
- Construction provisions for the SC structures forming the CA Modules (refer to Section 4.16.7.2)
- Construction provisions for the SC structures forming the ESB circular wall (refer to Section 4.16.8.3)

948 Assessment Findings and GDA Issues have been raised on the above and are not repeated here. Nevertheless, the full suite of construction specifications and contractors' quality plans and method statements should be made available for regulatory review at the construction phase.

4.25 Operational Inspection and Maintenance

949 The inspection and maintenance of civil structures throughout the lifetime of the AP1000 is required to comply with License Condition 28.

950 Westinghouse has maintained that the precise inspection and maintenance programmes will be determined by the site licensee and operator.

951 Therefore, I consider the bulk of these activities will be defined as part of the site specific phase and so have not been considered in detail in this report.

4.26 Decommissioning

4.26.1 Assessment

952 The detailed assessment of decommissioning of the AP1000 is contained in Step 4 Assessment Report ONR-GDA-AR-11-014 (Ref. 49). This section of my report is solely related to the decommissioning of the civil structures with the scope of GDA. My report also does not directly address the issues of decontamination of civil structures or treatment of radioactive waste arising.

953 The key SAPs which are applicable to this subject are as follows:

Decommissioning	Design and operation	DC.1
Facilities should be designed and operated so that they can be safely decommissioned.		

“687 Account should be taken during the planning, design, construction and operational stages of the need for decommissioning and waste retrieval. This should include:

- a) design measures to minimise activation and contamination, etc;
- b) physical and procedural methods to prevent the spread of contamination;
- c) control of activation;
- d) design features to facilitate decommissioning and to reduce dose uptake by decommissioning workers;
- e) consideration of the implications for decommissioning when modifications to and experiments on the facility are proposed;
- f) identification of reasonably practicable changes to the facility to facilitate or accelerate decommissioning;
- g) minimising the generation of radioactive waste.”

954 The AP1000 Decommissioning Plan, UKP-GW-GL-795, (Ref. 213) provides Westinghouse’s suggested approach to decommissioning. Chapter 16 of the 2009 PCSR describes decommissioning. Section 7.9 and Chapter 27 of the 2010 PCSR gives additional information, as does the EDCD Section 20.2. However, Ref. 213 is taken as the primary reference.

955 Westinghouse claims in Section 1.0 of Ref. 213 that:

- *It is feasible to decommission an AP1000 plant using current technology*
- *Decommissioning issues were appropriately considered in the overall design*
- *The utility operator is expected to prepare their own decommissioning plan and update it from time to time.*

956 Westinghouse takes due cognisance of the UK Construction (Design and Management) Regulations 2007 (CDM2007) (Ref. 214) and states that “as a designer of the AP1000 plant, Westinghouse will make provision for the transfer of knowledge relating to the construction, operation and maintenance of the AP1000 plant. The knowledge transfer and management arrangements developed to support operation of the AP1000 plant will provide the foundations of the arrangements required for decommissioning.”

957 AP1000 design features that facilitate decommissioning are described in Section 4.1.4 of Ref. 213 thus “In addition to the design features that minimise waste, reduce contamination and facilitate decommissioning the plant containment and structures are designed to retain their integrity for the expected operational life of the plant and the subsequent decommissioning period.”

4.26.2 Findings

958 The formal decommissioning plan and safety case will be prepared by the licensee at the end of the facility’s operating life. However, design decisions made from concept through to detailed design can significantly affect the ease of decommissioning. The CDM2007 regulations place a responsibility on the designer to undertake proper consideration of these aspects in their design.

959 I have seen no evidence of optioneering of the civil designs within the generic plant which consider the ease of decommissioning. This is one of the requirements of the CDM2007 Regulations and is discussed further in Section 4.29.1. Where the form of construction of the AP1000 is traditional reinforced concrete and structural steel, these can be

decommissioned using techniques currently available. Westinghouse states that the use of modular construction will be beneficial to final dismantling, since modules can be removed in the reverse sequence to construction. I do not agree with this statement, since the modules will be filled with concrete and thus will be much heavier than when they were first placed.

960 Since the provision of a decommissioning plan by the designer is included in the CDM2007 Regulations, this is captured in **AF-AP1000-CE-60** in Section 4.29.1.

4.27 Overseas Regulatory Interface

961 HSE's Strategy for working with overseas regulators is set out in (Ref. 215) and (Ref. 216). In accordance with this strategy, HSE collaborates with overseas regulators, both bilaterally and multi-nationally.

962 During the GDA process, meetings and discussions have been held primarily with the US Nuclear Regulatory Commission (US NRC), who has been undertaking assessment of the enhanced Shield Building in parallel with Step 3 and Step 4 of GDA. I was invited to attend a meeting, called by US NRC, in June 2010 with Westinghouse and participated in forming the actions from that meeting. I have also had various discussions and meetings with US NRC technical inspectors to discuss various aspects of the ESB design.

963 The US NRC approach is to be much more prescriptive to the extent that it writes design guides and standards. I have recognised the differences in Regulatory approach and expectations between ONR and US NRC, particularly when reviewing information submitted by Westinghouse to US NRC or considering the findings of US NRC.

964 I have also liaised with the Chinese Regulator, the National Nuclear Safety Administration, during the Multinational Design Evaluation Programme (MDEP) meeting in March 2010 in Sanmen, China. As AP1000 stations are currently being built in China, this is a valuable source of experience in construction issues. I would therefore look to increase exchange of information during the future site licensing phase.

4.28 Interface with Other Regulators

4.28.1 Environment Agency

965 I have liaised with the Environment Agency during Step 4 of GDA. Common areas of assessment are on matters around flood risk to the plant and on liquid discharges to the environment. Aerial discharges are within the scope of the fault studies and radiological protection topics.

966 At the generic stage, flooding from external sources (e.g. sea, rivers, and rain) cannot really be considered in a meaningful way as these are site specific and have not been considered during GDA. The containment of radioactive liquids within the plant is an area of common interest.

967 The Environment Agency's Report for the Generic Design Assessment of the AP1000 (Ref. 217) has considered Westinghouse's use of best available techniques (BAT) for containing radioactive liquids in the AP1000. Section 8.3 of that report states that the Environment Agency "*expects these liquids to be contained within the facility to prevent contamination of land or groundwater under normal conditions. Under fault conditions we expect BAT to be used to minimise the probability of contamination occurring and the extent of contamination.*"

- 968 The underlying principles used for its assessment are set out in the Environment Agency Regulatory Guidance document, RSR1 Radioactive Substances Regulation – Environmental Principles (Ref. 218). This details how the Agency regulates radioactive substances activities under the Environmental Permitting (England and Wales) Regulations 2010. The principles relevant to liquid discharges are:
- The radioactive substance management developed principle number 10 (RSMDP10) details the Environment Agency’s expectations on how radioactive substances should be stored so that their environmental risk and impact are minimised.
 - The contaminated land developed principle number 1 (CLDP1) details the Environment Agency’s expectations on prevention/minimisation of contamination of land and groundwater.
- 969 A review of the principles RSMDP10 and CLDP1 confirms that they are consistent with the SAPs.
- 970 My assessment has highlighted the need for Westinghouse to substantiate its provision of secondary containment for the spent fuel pool. The Environment Agency has noted that Westinghouse claims that potential leaks from the spent fuel pool would be contained within the building. The Environment Agency has concluded this approach to be acceptable. My assessment requires further substantiation of the civil engineering methods to be used to achieve this (**GI-AP1000-CE-04**).
- 971 During the regulation of site specific facilities, there will be a need for regular and structured interfacing with the Environment Agency on matters around flood risk and discharges.

4.29 Other Health and Safety Legislation

4.29.1 The Construction (Design and Management) Regulations 2007

- 972 The design of the AP1000 plant by Westinghouse is subject to the UK regulations, the Construction (Design and Management) Regulations 2007 (CDM2007) for building projects. This places specific duties on all parties, including the designer to review the safety of the construction, operation and demolition of a project and whether different methods or design details can be adopted which result in safer practices. These duties apply from the inception of a design through concept and detailed design.
- 973 Westinghouse has recognised its duties as designer under CDM2007 in the AP1000 Decommissioning Plan, UKP-GW-GL-795, (Ref. 213). Although I have not seen any evidence of design optioneering or risk assessments with respect to CDM2007, I am encouraged that Westinghouse’s approach, QA procedures for design reviews and compliance with US regulations are in line with this important UK legislation.
- 974 I expect that when a client for the AP1000 is identified, Westinghouse will advise it of the client’s responsibilities under CDM2007. I also expect that the appropriate design reviews and risk assessments will be submitted/ produced to be incorporated in the Health and Safety File.
- 975 To track the above concerns I raise the following Assessment Finding which must be addressed prior to milestone 2 – first concrete.

AF-AP1000-CE-60: The licensee shall ensure that due consideration is given to the UK Construction (Design and Management) Regulations for the design of all civil structures (nuclear safety and non-nuclear safety structures).

5 CONCLUSIONS

- 976 This report presents the findings of the Step 4 Civil Engineering and External Hazards assessment of the Westinghouse AP1000 reactor. This has achieved the aims of the Step 4 plan as far as practicable and has investigated other areas, which came to light during my assessment.
- 977 To conclude, I am broadly satisfied with the claims, arguments and evidence laid down within the PCSR and supporting documentation for the Civil Engineering and External Hazards. I consider that from a Civil Engineering and External Hazards view point, the Westinghouse AP1000 design is suitable for construction in the UK. However, this conclusion is subject to satisfactory progression and resolution of the GDA Issues identified. This must be addressed during the forward programme for this reactor and assessment of additional information that becomes available as the GDA Design Reference is supplemented with additional details on a site-by-site basis. In some areas of the civil design, re-analysis will be needed in the site specific stage to take account of the actual site that has been chosen. This work has been identified in the list of 60 Assessment Findings.
- 978 During GDA Step 4 there was an event at the Fukushima Nuclear power plant in Japan in March 2011. The GDA Issue **GI-AP1000-CC-03** (Ref. 62) has been raised as a cross-cutting issue which requires Westinghouse to demonstrate how they will be taking account of the lessons learnt from the events at Fukushima, including those lessons and recommendations that are identified in the ONR Chief Inspector's interim and final reports.

5.1 Key Findings from the Step 4 Assessment

5.1.1 Civil Engineering and External Hazards

- 979 My assessment has reviewed the generic design of the civil engineering structures by carrying out high level reviews for the plant, complemented by deeper samples for certain structures identified as significant.
- 980 The key issue arising from the Step 3 assessment was the use of the novel steel-concrete sandwich construction for the walls of the CA Modules and for the majority of the enhanced Shield Building cylindrical wall. The claimed design methodology considers that these can be designed according to ACI-349 as traditionally reinforced concrete. Significant progress has been made by Westinghouse during Step 4 to justify the structural design. However, further justification is required as detailed in GDA issues **GI-AP1000-CE-01** (Ref. 63) and **GI-AP1000-CE-02** (Ref. 64).
- 981 The AP1000 has been designed in imperial units. Westinghouse proposes a quasi metric design, i.e. final drawings and documents will show metric equivalent of the original imperial values. However, I am concerned that not all civil structures will readily convert to metric and that on-site testing may use US standards/materials which are unfamiliar to local suppliers. Metrication has been raised as cross-cutting GDA Issue under **GI-AP1000-ME-02** (Ref. 59).
- 982 I conclude that the US specifications for construction materials used in the generic design need to be revised to match European normal practice. This is covered by GDA Issue **GI-AP1000-CE-03** (Ref. 65).
- 983 UK regulator expectations are that two levels of containment should be provided for the water within the spent fuel pool and associated pools. Since the pool structures are also

CA Modules, the current AP1000 design needs to be refined to provide confidence that are two levels of containment, each with a leak detection and retention system. This is covered by GDA Issue **GI-AP1000-CE-04** (Ref. 66).

- 984 The assessment of the categorisation and classification of the buildings under consideration has confirmed these are appropriate.
- 985 Westinghouse's continued use of superseded codes and standards for design is not considered as best practice. However, it has carried out a study to compare the codes used with the current versions and has committed to address any shortfalls prior to construction. This is raised as an Assessment Finding AF-AP1000-CE-05. In any case, a requirement of the UK Regulatory framework requires such an assessment every 10 years for all nuclear power plants.
- 986 The results of the screening of external hazards are acceptable, although the screening process itself was not transparent. Several external hazards are site specific: the most significant to civil structural design being the seismic analysis. Westinghouse's expectation is that the UK site specific seismic spectra will be adequately bounded by the generic design spectra and thus will not affect the detailed design already completed. However, its current seismic design methodology has shortfalls with respect to soft sites, which will need to be addressed for the site specific phase, including interaction between buildings and derivation of floor response spectra for plant qualifications. These requirements are raised as an Assessment Findings AF-AP1000-CE-06, 07, 23 and 24.
- 987 Application of the external hazards load schedule is broadly satisfactory and any shortfalls have been highlighted as Assessment Findings.
- 988 Derivation of the loads from internal hazards has been assessed under the Internal Hazards Report ONR-GDA-AR-11-001 (Ref. 35). Westinghouse has claimed that some internal hazards are bounded by others and so these loadings need not be considered. This has not been sufficiently justified and so GDA Issues **GI-AP1000-IH-03** to **GI-AP1000-IH-06** (Refs. 54 to 57) have been raised. The outcomes could affect the civil structural design load cases and hence the design forces.
- 989 The use of sub-contractors to design and detail certain civil structures was investigated. Although the design organisations used are in diverse locations, no evidence was found, which raised concerns that the specification and completion of designs had not been carried out correctly.
- 990 The Radwaste Building was not included in the scope of GDA and so will need to be considered during site specific phase, along with the other site specific structures.

5.1.2 Assessment Findings

- 991 I have raised 60 Assessment Findings for the civil engineering and external hazards assessment of the AP1000 generic design. These comprise items which can only be resolved during the site specific stage, but have come to light during the generic design assessment. The most significant of these are listed above in Section 5.1.1.
- 992 I conclude that the Assessment Findings listed in Annex 1 should be programmed during the forward programme of this reactor as normal regulatory business.

5.1.3 GDA Issues

993 I have raised four GDA Issues with a number of attached actions for my assessment on civil engineering and external hazards of the AP1000 generic design. The complete GDA Issues and associated actions are formally defined in Annex 2 of this report. I conclude that these GDA Issues, listed in Annex 2, must be satisfactorily addressed before Consent is granted for the commencement of nuclear island safety related construction.

994 I also conclude that there are GDA Issues raised under other assessment topics and as cross-cutting issues, which must also be addressed. These are:

- **GI-AP1000-ME-02:** metrication.
- **GI-AP1000-IH-01:** internal flooding.
- **GI-AP1000-IH-02:** internal fire.
- **GI-AP1000-IH-03:** pressure part failure.
- **GI-AP1000-IH-04:** internal explosion.
- **GI-AP1000-IH-05:** internal missiles.
- **GI-AP1000-IH-06:** dropped loads and impacts.
- **GI-AP1000-EE-01:** substantiation of the electrical distribution system
- **GI-AP1000-CC-01:** operational limits and conditions
- **GI-AP1000-CC-02:** PCSR and Safety Submission Documentation
- **GI-AP1000-CC-03:** Actions to address lessons learnt from Fukushima.

995 For details of these GDA Issues see the appropriate Step 4 Assessment Reports (Refs. 35, 42, 45 and 51).

6 REFERENCES

- | <i>Ref.</i> | <i>Title</i> |
|-------------|---|
| 1 | <i>AP1000 Pre-construction Safety Report.</i> UKP-GW-GL-793 Revision A. Westinghouse Electric Company LLC. December 2010. TRIM Ref. 2011/23783. |
| 2 | <i>AP1000 Master Submission List.</i> UKP-GW-GLX-001 Revision A. Westinghouse Electric Company LLC. February 2011. TRIM Ref. 2011/98980. |
| 3 | <i>ND BMS. Assessment Process.</i> AST/001. Issue 4. April 2010.
www.hse.gov.uk/foi/internalops/nsd/assessment/ast001.htm |
| 4 | <i>Safety Assessment Principles for Nuclear Facilities.</i> 2006 Edition Revision 1. HSE. www.hse.gov.uk/nuclear/saps/saps2006.pdf |
| 5 | <i>Westinghouse AP1000 - Schedule of Technical Queries Raised during Step 4.</i> HSE-ND. TRIM Ref. 2010/600721. |
| 6 | <i>Westinghouse AP1000 - Schedule of Regulatory Observations Raised during Step 4.</i> HSE-ND. TRIM Ref. 2010/600724. |
| 7 | <i>Westinghouse AP1000 - Schedule of Regulatory Issues Raised during Step 4.</i> HSE-ND. TRIM Ref. 2010/600725. |
| 8 | <i>New nuclear power station Generic Design Assessment – guidance to requesting parties.</i> Version 3. HSE. August 2008.
http://www.hse.gov.uk/newreactors/ngn03.pdf |
| 9 | <i>Clarification of GDA Out of Scope Items.</i> UN REG WEC000512. Letter to ND from Westinghouse Electric Company LLC. 17 February 2011. TRIM Ref. 2011/105073. |
| 10 | <i>AP1000 Pre-construction Safety Report.</i> UKP-GW-GL-732 Revision 2, Westinghouse Electric Company LLC. December 2009. TRIM Ref. 2011/23759. |
| 11 | <i>GDA Step 4 Civil Engineering and External Hazards Assessment Plan for the Westinghouse AP1000.</i> HSE-ND Assessment Plan AR 10/001. June 2010. TRIM Ref. 2010/263191. |
| 12 | <i>ND BMS. Technical Reports.</i> AST/003 Issue 3. HSE. November 2009.
www.hse.gov.uk/foi/internalops/nsd/assessment/ast003.htm |
| 13 | <i>ND BMS. Technical Assessment Guide. External Hazards.</i> T/AST/013 Issue 3. HSE. April 2009.
www.hse.gov.uk/foi/internalops/nsd/tech_asst_guides/tast013.htm . |
| 14 | <i>ND BMS. Technical Assessment Guide. Structural Integrity Civil Engineering Aspects.</i> T/AST/017 Issue 2. HSE. March 2005.
www.hse.gov.uk/foi/internalops/nsd/tech_asst_guides/tast017.pdf |
| 15 | <i>ND BMS. Technical Assessment Guide. Validation of Computer Codes and Calculation Methods.</i> T/AST/042 Issue 1. HSE. July 2000.
www.hse.gov.uk/foi/internalops/nsd/tech_asst_guides/tast042.pdf |
| 16 | <i>ND BMS. Technical Assessment Guide. licensee use of contractors and intelligent customer capability.</i> T/AST/049 Issue 3. HSE. September 2009.
www.hse.gov.uk/foi/internalops/nsd/tech_asst_guides/tast049.htm |

<i>Ref.</i>	<i>Title</i>
17	<i>ND BMS. Technical Assessment Guide. Design Safety Assurance. T/AST/057 Issue 2. HSE. November 2010.</i> www.hse.gov.uk/foi/internalops/nsd/tech_asst_guides/tast057.htm
18	<i>Western European Nuclear Regulators' Association. Reactor Harmonization Group. WENRA Reactor Reference Safety Levels. WENRA. January 2008.</i> www.wenra.org
19	<i>Safety of Nuclear Power Plants: Design. Safety Requirements. Safety Standards Series No. NS-R-1. International Atomic Energy Agency (IAEA). Vienna. 2000.</i>
20	<i>Step 3 Civil Engineering and External Hazards Assessment of the Westinghouse AP1000. HSE-ND Assessment Report AR 09/034. November 2009. TRIM Ref. 2009/399229.</i>
21	<i>AP1000 Pre-construction Safety Report. UKP-GW-GL-732 Revision 1. Westinghouse Electric Company LLC. March 2009. TRIM Ref. 2009/151068.</i>
22	<i>Code Requirements for Nuclear Safety-Related Concrete Structures and Commentary. ACI 349-01. American Concrete Institute. 2001.</i>
23	<i>AP1000 External Hazard Assessment: Detailed Review of External Hazard Load Derivation Methodology and Subsequent Application. Report No 2342643-R01 Issue 2. ABS Consulting. March 2011. TRIM Ref. 2011/19406.</i>
24	<i>Review of Selection and Screening Methodology Applied to External Hazards within the AP1000 Probabilistic Risk Assessment. Report No 2342643-R02 Issue 1. ABS Consulting. March 2011. TRIM Ref. 2011/19441.</i>
25	<i>AP1000 Seismic Margins Assessment: GDA Review of Seismic Fragility Derivation. Report No 2342643-R03 Issue 1. ABS Consulting. July 2011. TRIM Ref. 2011/19449.</i>
26	<i>Sampling of the Westinghouse Quality Assurance Procedures for the AP1000 Design in the Context of Civil Engineering. Report No 2342643-R04 Issue 1. ABS Consulting. July 2011. TRIM Ref. 2011/19460.</i>
27	<i>AP1000 External Hazards: Application of Load Schedule. Report No 2342643-R-05 Issue 1. ABS Consulting. July 2011. TRIM Ref. 2011/403439.</i>
28	<i>Numerical Analysis of Aspects of the AP1000 Design. 16603-TR0001 Issue 1. Amec Nuclear UK Ltd. May 2011. TRIM Ref. 2011/287980.</i>
29	<i>Design Assessment of the AP1000 Modular Construction. 16603-TR0002 Issue 3. Amec Nuclear UK Ltd. May 2011. TRIM Ref. 2011/288011.</i>
30	<i>Review of Atkins and AMEC Reports. 209364-04-T1 Issue 2. ARUP. July 2011. TRIM Ref. 2011/295678.</i>
31	<i>Evaluation of the methodology for the design of the CA Modules. 209364-04-T2 Issue 2. ARUP. July 2011. TRIM Ref. 2011/295684.</i>
32	<i>Evaluation of the design of the Enhanced Shield Building. 209364-04-T3 Issue 2. ARUP. July 2011. TRIM Ref. 2011/295694.</i>
33	<i>Evaluation of Aircraft Crash Design. 209364-04-T4 Issue 1. ARUP. August 2011. TRIM Ref. 2011/425117.</i>

<i>Ref.</i>	<i>Title</i>
34	<i>AP1000 Civil Engineering: Evaluation of Seismic Methodology.</i> 209364-04-T5 Issue 2. ARUP. July 2011. TRIM Ref. 2011/295710.
35	<i>Step 4 Internal Hazards Assessment of the Westinghouse AP1000[®] Reactor.</i> ONR Assessment Report ONR-GDA-AR-11-001, Revision 0. TRIM Ref. 2010/579786
36	Not used.
37	<i>Step 4 Probabilistic Safety Analysis Assessment of the Westinghouse AP1000[®] Reactor.</i> ONR Assessment Report ONR-GDA-AR-11-003, Revision 0. TRIM Ref. 2010/581527.
38	<i>Step 4 Fault Studies – Design Basis Faults Assessment of the Westinghouse AP1000[®] Reactor.</i> ONR Assessment Report ONR-GDA-AR-11-004a, Revision 0. TRIM Ref. 2010/581406.
39	<i>Step 4 Fault Studies – Containment and Severe Accident Assessment of the Westinghouse AP1000[®] Reactor.</i> ONR Assessment Report ONR-GDA-AR-11-004b, Revision 0. TRIM Ref. 2010/581405.
40	<i>Step 4 Fuel and Core Design Assessment of the Westinghouse AP1000[®] Reactor.</i> ONR Assessment Report ONR-GDA-AR-11-005, Revision 0. TRIM Ref. 2010/581526.
41	<i>Step 4 Control and Instrumentation Assessment of the Westinghouse AP1000[®] Reactor.</i> ONR Assessment Report ONR-GDA-AR-11-006, Revision 0. TRIM Ref. 2010/581525
42	<i>Step 4 Electrical Systems Assessment of the Westinghouse AP1000[®] Reactor.</i> ONR Assessment Report ONR-GDA-AR-11-007, Revision 0. TRIM Ref. 2010/581524.
43	<i>Step 4 Reactor Chemistry Assessment of the Westinghouse AP1000[®] Reactor.</i> ONR Assessment Report ONR-GDA-AR-11-008, Revision 0. TRIM Ref. 2010/581523.
44	<i>Step 4 Radiological Protection Assessment of the Westinghouse AP1000[®] Reactor.</i> ONR Assessment Report ONR-GDA-AR-11-009, Revision 0. TRIM Ref. 2010/581522.
45	<i>Step 4 Mechanical Engineering Assessment of the Westinghouse AP1000[®] Reactor.</i> ONR Assessment Report ONR-GDA-AR-11-010, Revision 0. TRIM Ref. 2010/581521.
46	<i>Step 4 Structural Integrity Assessment of the Westinghouse AP1000[®] Reactor.</i> ONR Assessment Report ONR-GDA-AR-11-011, Revision 0. TRIM Ref. 2010/581520.
47	<i>Step 4 Human Factors Assessment of the Westinghouse AP1000[®] Reactor.</i> ONR Assessment Report ONR-GDA-AR-11-012, Revision 0. TRIM Ref. 2010/581519

<i>Ref.</i>	<i>Title</i>
48	<i>Step 4 Management of Safety and Quality Assurance Assessment of the Westinghouse AP1000[®] Reactor. ONR Assessment Report ONR-GDA-AR-11-013, Revision 0. TRIM Ref. 2010/581518.</i>
49	<i>Step 4 Radioactive Waste and Decommissioning Assessment of the Westinghouse AP1000[®] Reactor. ONR Assessment Report ONR-GDA-AR-11-014, Revision 0. TRIM Ref. 2010/581517.</i>
50	<i>Step 4 Security Assessment of the Westinghouse AP1000[®] Reactor HSE-ND Assessment Report ONR-GDA-AR-11-015, Revision 0. TRIM Ref. 2010/581516.</i>
51	<i>Step 4 Cross-cutting Topics Assessment of the Westinghouse AP1000[®] Reactor HSE-ND Assessment Report ONR-GDA-AR-11-016, Revision 0. TRIM Ref. 2010/581515.</i>
52	<i>GDA Issue GI-AP1000-IH-01 Revision 0, Internal Flooding Safety Case. HSE-ND. TRIM Ref. 2011/369342</i>
53	<i>GDA Issue GI-AP1000-IH-02 Revision 0, Internal Fire Safety Case Substantiation. HSE-ND. TRIM Ref. 2011//369344</i>
54	<i>GDA Issue GI-AP1000-IH-03 Revision 0, Pressure Part Failure. HSE-ND. TRIM Ref. 2011/369346.</i>
55	<i>GDA Issue GI-AP1000-IH-04 Revision 0, Internal Explosion Safety Case Substantiation. HSE-ND. TRIM Ref. 2011/369348.</i>
56	<i>GDA Issue GI-AP1000-IH-05 Revision 0, Internal Missile Safety Case. HSE-ND. TRIM Ref. 2011/369350.</i>
57	<i>GDA Issue GI-AP1000-IH-06 Revision 0, Substantiation and Analysis of the Consequences of Dropped Loads and Impact from Lifting Equipment Included Within the AP1000 Design. HSE-ND. TRIM Ref. 2011/369351.</i>
58	<i>GDA Issue GI-AP1000-EE-01 Revision 0. Substantiate the design of the complete Plant Electrical Distribution System. HSE-ND. TRIM Ref. 2011/81258.</i>
59	<i>GDA Issue GI-AP1000-ME-02 Revision 1 – Metrication of Mechanical Equipment and Civil Structural Steelwork Connections. HSE-ND. TRIM Ref. 2011/81321.</i>
60	<i>GDA Issue GI-AP1000-CC-01 Revision 0 - Operational limits and conditions derived from the safety case. HSE-ND. TRIM Ref. 2011/126740.</i>
61	<i>GDA Issue GI-AP1000-CC-02 Revision 3. PCSR and Safety Submission Documentation to Support GDA. HSE-ND. TRIM Ref. 2011/123143.</i>
62	<i>GDA Issue GI-AP1000-CC-03 Revision 2. Consider and action plans to address the lessons learnt from the Fukushima event. HSE-ND. TRIM Ref. 2011/259807.</i>
63	<i>GDA Issue GI-AP1000-CE-01 Revision 0. Justification of Novel Form of Structure for the Steel/ Concrete Composite Walls and Floors Known as CA Modules. TRIM Ref. 2011/134044.</i>
64	<i>GDA Issue GI-AP1000-CE-02 Revision 0. Further Justification of Novel Form of Structure for the Steel/ Concrete Composite Wall to The Enhanced Shield Building. TRIM Ref. 2011/134046.</i>

<i>Ref.</i>	<i>Title</i>
65	<i>GDA Issue GI-AP1000-CE-03 Revision 0. Materials – AP1000 Material Standards and Material Specifications.</i> TRIM Ref. 2011/134035.
66	<i>GDA Issue GI-AP1000-CE-04 Revision 0. Fuel Handling Area – Secondary Containment Leak Detection and Collection System.</i> TRIM Ref. 2011/134037.
67	<i>AP1000 European Design Control Document.</i> EPS-GW-GL-700 Revision 1. Westinghouse Electric Company LLC. December 2009. TRIM Ref. 2010/2083.
68	<i>AP1000 Pre-Construction Safety Report.</i> UKP-GW-GL-793 Revision A. UN REG WEC000448. Letter to ND from Westinghouse Electric Company LLC. 16 December 2010. TRIM Ref. 2011/37693.
69	<i>Design for the AP1000 Enhanced Shield Building.</i> APP-1200-S3R-003 Revision 0. Westinghouse Electric Company LLC. August 2009 TRIM Ref. 2011/191924.
70	<i>Design Report for the AP1000 Enhanced Shield Building.</i> APP-1200-S3R-003 Revision 1. Westinghouse Electric Company LLC. March 2010. TRIM Ref. 2011/79103.
71	<i>Design Report for the AP1000 Enhanced Shield Building.</i> APP-1200-S3R-003 Revision 2. Westinghouse Electric Company LLC. May 2010. TRIM Ref. 2011/79104.
72	<i>Design Report for the AP1000 Enhanced Shield Building.</i> APP-1200-S3R-003 Revision 3. Westinghouse Electric Company LLC. September 2010. TRIM Ref. 2011/79778.
73	<i>AP1000 Westinghouse Response to RI-AP1000-02 and RO-AP1000-079.</i> UKP-GW-GLR-018 Revision A. Westinghouse Electric Company LLC. October 2010. TRIM Ref. 2011/82106.
74	<i>AP1000 Internal Hazards Topic Report.</i> UKP-GW-GLR-001 Revision 1. Westinghouse Electric Company LLC. February 2010. TRIM Ref. 2011/79948.
75	<i>AP1000 External Hazards Topic Report.</i> UKP-GW-GL-043 Revision 0. Westinghouse Electric Company LLC. December 2009. TRIM Ref. 2009/503652.
76	<i>AP1000 UK Safety Categorisation and Classification Methodology.</i> UKP-GW-GL-044 Revision 1. Westinghouse Electric Company LLC. May 2010. TRIM Ref. 2011/173949.
77	<i>AP1000 Equivalence/Maturity Study of the US Codes and Standards.</i> UKP-GW-GL-045 Revision 0. Westinghouse Electric Company LLC. TRIM Ref. 2011/79945.
78	<i>Summary of Automobile Tornado Missile 30' Above Grade.</i> APP-GW-GLR-133 Revision 1. Westinghouse Electric Company LLC. May 2010. TRIM Ref. 2011/93596.
79	<i>AP1000 Probabilistic Risk Assessment.</i> APP-GW-GL-022 Revision.0. Westinghouse Electric Company LLC. July 2004. TRIM Ref. 2011/79753.
80	<i>Wind Evaluation Procedures and Code Requirements.</i> APP-GW-C1C-001 Revision 0. Westinghouse Electric Company LLC. April 2004. TRIM Ref. 2011/93473.

<i>Ref.</i>	<i>Title</i>
81	<i>AP1000 Civil/Structural Design Criteria.</i> APP-GW-C1-001 Revision 1. Westinghouse Electric Company LLC. 14 September 2005. TRIM Ref. 2011/79441.
82	<i>AP1000 Seismic Design Criteria.</i> APP-GW-G1-003 Revision 3. Westinghouse Electric Company LLC. September 2009. TRIM Ref. 2011/79447.
83	<i>AP1000 General Layout Criteria.</i> APP-GW-P1-002 Revision 0. Westinghouse Electric Company LLC. May 2009. TRIM Ref. 2011/81422.
84	<i>Nuclear Island: Evaluation of Critical Sections.</i> APP-GW-GLR-045 Revision 0. Westinghouse Electric Company LLC. March 2007. TRIM Ref. 2011/478961.
85	<i>Design Methodology for Structural Modules.</i> APP-GW-SUP-001 Revision 1. Westinghouse Electric Company LLC. February 2010. TRIM Ref. 2011/81429.
86	<i>Design Methodology for Structural Modules.</i> APP-GW-SUP-001 Revision 2. Westinghouse Electric Company LLC. October 2010. TRIM Ref. 2011/81430.
87	<i>AP1000 Barrier Matrix.</i> APP-1000-GEC-004 Revision A. Westinghouse Electric Company LLC. January 2010. TRIM Ref. 2011/79762.
88	<i>AP1000 UK Safety Categorisation and Classification of Systems, Structures and Components.</i> UKP-GW-GL-144 Revision 1. Westinghouse Electric Company LLC. January 2011. TRIM Ref. 2011/91066.
89	<i>ASME Boiler and Pressure Vessel Code: Section III Division 1: Subsection NE Metal Containment.</i> American Society of Mechanical Engineers. 2001 Edition plus 1 st July 2002 Addenda.
90	<i>UBC-97 Uniform Building Code.</i> International Conference of Building Officials. 1997.
91	<i>Minimum Design Loads in Buildings and other Structures.</i> ASCE 7-98. American Society of Civil Engineers. 2000.
92	<i>Seismic Analysis of Safety-Related Nuclear Structure.</i> ASCE 4-98. American Society of Civil Engineers. 2000.
93	<i>Building Code Requirements for Structural Concrete and Commentary.</i> ACI 318R-05. American Concrete Institute. 2001.
94	<i>Specification for Structural Concrete.</i> ACI 301-05. American Concrete Institute. 2005.
95	<i>ACI Detailing Manual.</i> SP-66 – 1994. American Concrete Institute. 1994.
96	<i>Specification for the Design, Fabrication, and erection of Steel Safety-related Structures for Nuclear Facilities (including Supplement No. 20).</i> ANSI/AISC N690-94. American Institute of Steel Construction. 1994.
97	<i>Seismic Provisions for Structural Steel Building Buildings.</i> ANSI/AISC 341-97. American Institute of Steel Construction (AISC). 1997.
98	<i>Seismic Provisions for Structural Steel Building Buildings Supplement No. 2.</i> ANSI/AISC 341-97. American Institute of Steel Construction (AISC). November 2000.

<i>Ref.</i>	<i>Title</i>
99	<i>Load and Resistance Factor Design (LRFD) Specification for Structural Steel Buildings.</i> American Institute of Steel Construction. December 1999
100	<i>Specification for Structural Steel Buildings - Allowable Stress Design (ASD) and Plastic Design.</i> American Institute of Steel Construction (AISC). June 1989.
101	<i>International Building Code.</i> International Code Council. 2009
102	<i>Minimum Design Loads in Buildings and Other Structures.</i> ASCE 7-10. American Society of Civil Engineers. 2010.
103	<i>Seismic Analysis of Safety Related Nuclear Structures.</i> ASCE 4-98. American Society of Civil Engineers.
104	<i>Code Requirements for Nuclear Safety Related Concrete Structures and Commentary.</i> ACI 349R-06. American Concrete Institute. 2006.
105	<i>Reinforced Concrete Design for Thermal Effects on Nuclear Power Plant Structures.</i> ACI 349.1R-07. American Concrete Institute. 2007.
106	<i>Code Requirements for Nuclear Safety related Concrete Structures and Commentary.</i> ACI 349R-XX Draft standard. American Concrete Institute.
107	<i>Building Code Requirements for Structural Concrete and Commentary.</i> ACI 318-02. American Concrete Institute. 2002.
108	<i>Specifications for Structural Concrete.</i> ACI 301-10. American Concrete Institute. 2010.
109	<i>Specification for Safety-Related Steel Structures for Nuclear Facilities.</i> ANSI/AISC N690-06. American Institute of Steel Construction. 2006.
110	<i>Specification for Modular Composite Walls and Slabs in Safety-Related Structures and Nuclear Facilities.</i> AISC N690-11 Appendix N9 (Draft). American Institute of Steel Construction. 2011.
111	<i>Seismic Provisions for Structural Steel Building Buildings.</i> ANSI/AISC 341-02. American Institute of Steel Construction. 2002.
112	<i>Seismic Provisions for Structural Steel Building Buildings.</i> ANSI/AISC 341-05. American Institute of Steel Construction. 2005.
113	<i>Specification for Structural Steel Buildings.</i> AISC 360-05. American Institute of Steel Construction. 2005.
114	<i>Specification for Structural Steel Buildings.</i> AISC 360-10. American Institute of Steel Construction. 2010.
115	<i>Eurocode 8: Design of Structures for Earthquake Resistance.</i> BS EN 1998-1-1. British Standards Institute (BSi). 1998.
116	<i>United Kingdom Climate Projections 2009 (UKCP09).</i>
117	<i>Methodology for Performing Aircraft Impact Assessments and Large Explosion Assessments for New Plant Designs.</i> NEI 07-13 Revision 7. ERIN Engineering. May 2009.

<i>Ref.</i>	<i>Title</i>
118	<i>Standard Specification for High-Strength Low-Alloy Columbium-Vanadium Structural Steel.</i> ASTM A572. American Society for Testing and Materials (ASTM). 2007.
119	<i>Standard Specification for Carbon Structural Steel.</i> ASTM A36. American Society for Testing and Materials (ASTM).
120	<i>Specification for High-Strength Low-Alloy Structural Steel, up to 50ksi [345MPa] Minimum Yield Point, with Atmospheric Corrosion Resistance.</i> ASTM A588. American Society for Testing and Materials (ASTM).
121	<i>Weathering Steel for Highway Structures.</i> BD7/01. UK Highways Agency. November 2011.
122	<i>Eurocode 3:– Design of Steel Structures – General Rules and Rules for Buildings.</i> BS EN 1993-1-1:2004. British Standards Institute (BSi). 2004.
123	<i>Domestic AP1000 Project Specification: Safety Related Mixing and Delivering Concrete.</i> APP-CC01-Z0-026 Revision 2. Westinghouse Electric Company LLC. September 2010. TRIM Ref. 2011/79215.
124	<i>Standard Practice for Selecting Proportions for Normal, Heavyweight and Mass Concrete.</i> ACI 211.1. American Concrete Institute. 1991.
125	<i>Response to RO-AP1000-079.A7: Self Consolidating Concrete.</i> UN REG WEC 000370. Westinghouse Electric Company LLC. 30 September 2010. TRIM Ref. 2010/497433.
126	Not used.
127	<i>AP1000 Standard Plant Metrication.</i> APP-GW-G1-011 Revision 0. Westinghouse Electric Company LLC. November 2009. TRIM Ref. 2011/79448.
128	<i>Regulatory Observation RO-AP1000-38 and Regulatory Observation Action RO-AP1000-38.A1 – Metrication of the AP1000 for the UK.</i> Letter from ND to AP1000 Project Front Office. WEC70154R. 17 March 2010. TRIM Ref. 2010/120974.
129	<i>AP1000 Standard Plant Metrication.</i> APP-GW-G1-011 Revision 1. Westinghouse Electric Company LLC. April 2010. TRIM Ref. 2011/79450.
130	<i>AP1000 Standard Plant Metrication.</i> APP-GW-G1-011 Revision 2. Westinghouse Electric Company LLC. September 2010. TRIM Ref. 2011/79451.
131	<i>Westinghouse Updated Response to RO-AP1000-038, Metrication of the AP1000 for the UK: AP1000 Standard Plant Metrication.</i> Letter from ND to AP1000 Project Front Office. WEC70243R. 11 October 2010. TRIM Ref. 2010/491549.
132	<i>AP1000 Standard Plant Metrication.</i> APP-GW-G1-011 Revision 3. Westinghouse Electric Company LLC. December 2010. TRIM Ref. 2011/79452.
133	<i>Pre-standard and Commentary for the Seismic Rehabilitation of Buildings.</i> FEMA 356, Federal Emergency Management Agency. November 2000.

<i>Ref.</i>	<i>Title</i>
134	<i>Response to Action Items from GDA Civil Engineering Meeting.</i> UN REG WEC 000469. Letter to ND from Westinghouse Electric Company LLC. 9 January 2011. TRIM Ref. 2011/22886.
135	<i>Response to Action Items from November 30 – December 2 GDA Civil Engineering Meeting.</i> WEC000457. Letter to ND from Westinghouse Electric Company LLC. 24 December 2010. TRIM Ref. 2010/643910.
136	<i>Extension of Nuclear Island Seismic Analyses to Soil Sites.</i> APP-GW-S2R-010 Revision 4. Westinghouse Electric Company LLC. 18 March 2010. TRIM Ref. 2011/81428.
137	<i>Nuclear Island Seismic Floor Response Spectra.</i> APP-1000-S2C-056 Revision 2. Westinghouse Electric Company LLC. March 2010. TRIM Ref. 2011/79037.
138	<i>Seismic Design Criteria for Structures, Systems, and Components in Nuclear Facilities and Commentary.</i> ASCE 43-05. American Society of Civil Engineers. 2005.
139	Not used.
140	<i>Building Regulations 2010 and the Building (Approved Inspectors etc.) Regulations 2010,</i> (SI 2010/2214 and 2010/2215) UK Department of Communities and Local Government, 1 October 2010. www.legislation.gov.uk/uksi/2010/2214
141	<i>AP1000 2D SSI Analysis with Adjacent Buildings.</i> APP-1000-S2C-025 Revision 4. Westinghouse Electric Company LLC. October 2010. TRIM Ref. 2011/288059.
142	<i>Separation between Buildings.</i> Letter DCP_TOS_000334. Westinghouse Electric Company LLC, 26 Aug 2009. TRIM Ref. 2011/562526
143	<i>Design Report for the AP1000 Modules.</i> APP-1000-S3R-002 Revision A. Westinghouse Electric Company LLC. August 2010. TRIM Ref. 2011/79044.
144	<i>AP1000 Design Summary Report: Containment Internal Structures.</i> APP-1100-S3R-001 Revision 3. Westinghouse Electric Company LLC. August 2008. TRIM Ref. 2011/79072.
145	<i>Static Analysis of Containment Internal Structures – Load Combinations.</i> APP-1100-S2C-006 Revision 3. Westinghouse Electric Company LLC. March 2008. TRIM Ref. 2011/79057.
146	<i>Finite Element Solid-Shell Model of Containment Internal Structures.</i> APP-1100-S2C-034 Revision 0. Westinghouse Electric Company LLC. July 2008. TRIM Ref. 2011/79775.
147	<i>Static Analysis of Containment Internal Structures - Dead Load and Live Load.</i> APP-1100-S2C-001 Revision 0. Westinghouse Electric Company LLC. TRIM Ref. 2011/79163.
148	<i>Static Analysis of Containment Internal Structures – Pressures.</i> APP-1100-S2C-003 Revision 2. Westinghouse Electric Company LLC. TRIM Ref. 2011/79163.
149	<i>IRSWT Seismic Sloshing and Wall Flexibility.</i> APP-1100-S2C-009 Revision 1. TRIM Ref. 2011/550542.

<i>Ref.</i>	<i>Title</i>
150	<i>Static Analysis of Containment Internal Structures - SSE Equivalent Static Accelerations and Pressures.</i> APP-1100-S2C-002 Revision 4. Westinghouse Electric Company LLC. TRIM Ref. 2011/79163.
151	<i>Static Analysis of Containment Internal Structures - Thermal Analysis.</i> APP-1100-S2C-005 Revision 2. Westinghouse Electric Company LC. February 2011. TRIM Ref. 2011/130759.
152	<i>Static Analysis of Containment Internal Structures - Equipment & Piping Reactions.</i> APP-1100-S2C-010 Revision A. Westinghouse Electric Company LLC. TRIM Ref. 2011/79163.
153	<i>Non-linear thermal analysis of AP1000 CIS.</i> APP-1100-S3C-017 Revision A. Westinghouse Electric Company LLC. March 2011. TRIM Ref. 2011/136078.
154	<i>Response to Action Items from GDA Civil Engineering Meeting.</i> WEC000466. Letter to ND from Westinghouse Electric Company LLC. 30 December 2010. TRIM Ref. 2011/918.
155	<i>Enhanced Shield Building Roof Design.</i> APP-1278-CCC-001 Revision 1. Westinghouse Electric Company LLC. October 2008. TRIM Ref. 2011/192171.
156	<i>AP1000 Design Summary Report: Shield Building Roof.</i> APP-1278-CCC-002 Revision 0. Westinghouse Electric Company LLC. October 2008. TRIM Ref. 2011/192173.
157	<i>Structural Design Basis, Functional Specification, Modularisation and Construction Sequence for Shield Building Roof and Associated Structures.</i> APP-1277-S1-001 Revision A. Westinghouse Electric Company LLC. August 2008. TRIM Ref. 2011/79133.
158	<i>BS EN 1992-3 Eurocode 2. Design of concrete structures: Liquid-retaining and containment structures.</i> British Standards Institute (BSi). 2006.
159	<i>Auxiliary Building Load Combinations and Loads for Finite Element Analysis.</i> APP-1200-S2C-003 Revision 0. Westinghouse Electric Company LLC. August 2005. TRIM Ref. 2011/79100.
160	<i>Significance of Wind and Tornado Loads on ASB.</i> APP-1200-S2C-005 Revision 0. Westinghouse Electric Company LLC. 19 July 2006. TRIM Ref. 2011/79101.
161	<i>Auxiliary Building Wall 7.3 Dead Load, Live Load and Seismic Member Forces.</i> APP-1200-S2C-102 Revision 0. Westinghouse Electric Company LLC. 10 October 2002. TRIM Ref. 2011/79777.
162	<i>Auxiliary Building Wall 7.3 Reinforcement Design.</i> APP-1200-CCC-102 Revision 5. Westinghouse Electric Company LLC. December 2008. TRIM Ref. 2011/79776.
163	<i>ASB Fixed Base Static Analysis for Dead, Live and Seismic Loads.</i> APP-1200-S2C-001 Revision 2. Westinghouse Electric Company LLC. August 2005. TRIM Ref. 2011/79094.
164	<i>Auxiliary Building Concrete Slab Design EL 160'-6" Areas 3&4.</i> APP-1260-CCC-002 Revision 1. Westinghouse Electric Company LLC. August 2010. TRIM Ref. 2011/79781.

<i>Ref.</i>	<i>Title</i>
165	<i>Design Guide for Thermal Effects on Concrete Structures.</i> APP-GW-S1-009 Revision 0. TRIM Ref. 2011/550554.
166	<i>AP1000 Calculation of Nuclear Island Roof Snow Loads due to Snow Drift.</i> APP-1000-S3C-001 Revision 1. Westinghouse Electric Company LLC. January 2009. TRIM Ref. 2011/93349.
167	<i>Auxiliary Building – CA20 Wall Basic Design Calculation.</i> APP-CA20-CAC-011 Revision 1. Westinghouse Electric Company LLC. TRIM Ref. 2011/550546.
168	<i>Safety-Related Concrete Structures Nuclear Power Plants (Other than reactor vessels and containments).</i> Regulatory Guide 1.142 Revision 2. USNRC. November 2001.
169	<i>Policy, Technical and Licensing Issues Pertaining to Evolutionary and Advanced Light-Water Reactor (ALWR) Designs.</i> SECY-93-087, United States Nuclear Regulatory Commission. 1993.
170	<i>Auxiliary Building - CA20 Wall Basic Design Calculation.</i> APP-1200-CCC-010 Revision A. Westinghouse Electric Company LLC.(NOTE: believed to be superseded by APP-CA20-CAC-011 Ref.W65). TRIM Ref. 2011/192092.
171	<i>Response to RI-AP1000-02.A2.</i> Letter to ND from Westinghouse Electric Company LLC. UN REG WEC 000254. 30 June 2010. TRIM Ref. 2010/287729.
172	<i>Design Methodology for Structural Modules.</i> APP-GW-SUP-001 Revision 0. Westinghouse Electric Company LLC. February 2003. TRIM Ref. 2011/191905.
173	<i>Clarification of information in APP-1000-S3R-002.</i> Letter to ND from Westinghouse Electric Company LLC. UN REG WEC 000298. 19 Aug 2010. TRIM Ref. 2010/368962.
174	<i>Response to RO-AP1000-079.A3, Connections.</i> Letter to ND from Westinghouse Electric Company LLC. UN REG WEC 000367. 30 Sept 2010. TRIM Ref. 2010/484716.
175	<i>Response to RO-AP1000-079.A2, Design Methodology Justification.</i> Letter to ND from Westinghouse Electric Company LLC. UN REG WEC 000369. 30 Sept 2010. TRIM Ref. 2010/483284.
176	<i>Supporting Information for UKP-GW-GLR-018.</i> Letter to ND from Westinghouse Electric Company LLC. UN REG WEC 000405. 29 Oct 2010. TRIM Ref. 2010/546085.
177	<i>Response to Action Items from November 30 – December 2 GDA Civil Engineering Meeting.</i> Letter to ND from Westinghouse Electric Company LLC. UN REG WEC 000457. 24 Dec 2010. TRIM Ref. 2010/643910.
178	<i>Response to Action Items from GDA Civil Engineering Meeting.</i> Letter to ND from Westinghouse Electric Company LLC. UN REG WEC 000466. 30 Dec 2010. TRIM Ref. 2011/918.
179	<i>CA20 Connection Design: Module Wall to Basemat.</i> APP-CA20-S3C-002 Revision 4. Westinghouse Electric Company LLC. January 2011. TRIM Ref. 2011/79206.

-
- | <i>Ref.</i> | <i>Title</i> |
|-------------|--|
| 180 | <i>Module Test Program Summary.</i> APP-1000-T2R-027 Revision 0. Westinghouse Electric Company LLC. January 2011. TRIM Ref. 2011/79046. |
| 181 | <i>Revised Submittal of Action 4.1 – Truss Spacing.</i> Letter to ND from Westinghouse Electric Company LLC. UN REG WEC 000489. 26 Jan 2011. TRIM Ref. 2011/547640. |
| 182 | <i>Response to Action Item 12.1 – FE Modeling.</i> Letter to ND from Westinghouse Electric Company LLC. UN REG WEC 000498. 2 Feb 2011. TRIM Ref. 2011/74243. |
| 183 | <i>Module Test Program Summary.</i> APP-1000-T2R-027 Revision 1. Westinghouse Electric Company LLC. February 2011. TRIM Ref. 2011/126521. |
| 184 | <i>Report on Structural Analysis Methodology for Steel-Concrete Panels with Welded Shear Studs.</i> GW-SUP-003 Revision 2. Westinghouse Electric Company LLC. 19 June 1997. TRIM Ref. 2011/81877. |
| 185 | <i>Technical Guidelines for Aseismic Design of Steel Plate Reinforced Concrete Structures – Building and Structures.</i> JEAG 4618-2005. Japan Electric Association Nuclear Standards Committee. 2005. |
| 186 | <i>Integration to the structural modules inside containment - general design of trusses.</i> APP-1100-SUC-006 Revision 0. TRIM Ref. 2011/192031. |
| 187 | <i>Formwork for Concrete.</i> 4 th Edition. American Concrete Institute (ACI) |
| 188 | <i>European Guidelines for Self Compacting Concrete: Specification, Production and Use.</i> SCC 028. EFNARC. May 2005. www.efnarc.org |
| 189 | <i>Self-Compacting Concrete in Bridge Construction: Guide for design and construction.</i> Technical Guide No. 7. UK Concrete Centre. 2005. |
| 190 | <i>Structural modules – containment – effects of wet concrete placement stresses.</i> APP-1100-SUC-005 Revision 0. Westinghouse Electric Company LLC. 16 December 2005. TRIM Ref. 2011/79084. |
| 191 | <i>Design of Concrete Structures.</i> CAN/CSA.A23.3-04. Canadian Standards Association 2004. |
| 192 | <i>AASHTO LRFD Bridge Design Specification.</i> 3 rd edition. 2004 |
| 193 | <i>General Design of Shear Studs for Structural Modules for Inside Containment and CA20.</i> APP-1100-SUC-003 Revision 2. Westinghouse Electric Company LLC. 7 January 2011. TRIM Ref. 2011/79075. |
| 194 | <i>Nuclear Island Structural Modules Specification.</i> APP-GW-Z0-100 Revision 2. Westinghouse Electric Company LLC. November 2009. TRIM Ref. 2011/75536. |
| 195 | <i>Standard Specification for Steel Wire, Deformed, for Concrete Reinforcement.</i> ASTM A496. American Society of Testing and Materials. |
| 196 | <i>BS 8666:2005 Scheduling, dimensioning, bending and cutting of steel reinforcement for concrete.</i> British Standards Institute (BSI). September 2005. ISBN 978 0 580 60699 1. |
-

<i>Ref.</i>	<i>Title</i>
197	<i>Analysis of Containment Internal Structures – Floor at El. 107'-2"</i> . APP-1130-S3C-001 Revision 0. Westinghouse Electric Company LLC. 3 July 2008. TRIM Ref. 2011/192054.
198	<i>Design Guide for Reinforcement in Walls and Floor Slabs</i> . APP-GW-S1-008 Revision 1. Westinghouse Electric Company LLC. 22 July 2003. TRIM Ref. 2011/81426.
199	<i>CA20 Connection Design: Module Wall to Module Floor</i> . APP-CA20-S3C-001 Revision 0. Westinghouse Electric Company LLC. November 2007. TRIM Ref. 2011/79204.
200	<i>AP1000 Turbine Building Design Calculation: Seismic Response Analysis</i> . APP-2000-S2C-001 Revision 1. Westinghouse Electric Company LLC. 14 October 2010. TRIM Ref. 2011/79140.
201	<i>AP1000 Turbine Building Design Calculation: Turbine Building Material Properties and Basic Load Combinations</i> . APP-2000-S3C-001 Revision 1. Westinghouse Electric Company LLC. 14 October 2010. TRIM Ref. 2011/79141.
202	<i>Turbine Building Design Calculation: Turbine Building Wind and Tornado Loads</i> . APP-2000-S3C-002 Revision 1. Westinghouse Electric Company LLC. 14 October 2010. TRIM Ref. 2011/79143.
203	<i>AP1000 Turbine Building Design Calculation: First Bay (Part 1: Static Analysis and Seismic Response Analysis)</i> . APP-2100-S2C-001 Revision 1. Westinghouse Electric Company LLC. 14 October 2010. TRIM Ref. 2011/79155.
204	<i>AP1000 Turbine Building Design Calculation: First Bay (Part 2: Section Design)</i> . APP-2100-S3C-001 Revision 1. Westinghouse Electric Company LLC. 14 October 2010. TRIM Ref. 2011/79156.
205	<i>Turbine Building UBC 1997 Response Spectra</i> . APP-2000-S1C-002 Revision 0. Westinghouse Electric Company LLC. 30 December 2009. TRIM Ref. 2011/79138.
206	<i>AP1000 Turbine Building Design Calculation - Steel Framing Structure</i> . APP-2000-SSC-001 Revision 1. Westinghouse Electric Company LLC. 2011. TRIM Ref. 2011/79783.
207	<i>Structural Steel Buildings Allowable Stress Design and Plastic Design</i> . AISC S335. American Institute of Steel Construction (AISC). 1989.
208	<i>AP1000 Seismic Margin HCLPF Calculations</i> . APP-PRA-GSR-002 Revision 4. Westinghouse Electric Company LLC. July 2010. TRIM Ref. 2011/94125.
209	<i>Westinghouse Level II Policies and Procedures</i> . Westinghouse Electric Company LLC. March 2010. TRIM Ref. 2011/79937.
210	<i>Thickening of faceplates at the top of CA01 Module</i> . APP-GW-GEE-582 Revision 0. Westinghouse Electric Company LLC. 26 November 2008. TRIM Ref. 2011/79866.
211	<i>MSIV Compartment Structural Design Changes</i> . APP-GW-GEE-2081 Revision 0. Westinghouse Electric Company LLC. July 2010. TRIM Ref. 2011/79864.

<i>Ref.</i>	<i>Title</i>
212	Quality Management Systems: Requirements. BS EN ISO 9001. British Standards Institute. 2008.
213	<i>UK AP1000 Decommissioning Plan</i> . UKP-GW-GL-795 Revision 0. Westinghouse Electric Company LLC. December 2010. TRIM Ref. 2011/194286.
214	<i>The Construction (Design and Management) Regulations 2007</i> . Statutory Instrument No. 320.
215	<i>New nuclear power stations: UK Generic Design Assessment – Strategy for working with overseas regulators</i> . HSE. www.hse.gov.uk/newreactors/ngn04.pdf
216	<i>Guidance: Arrangements for obtaining support from overseas technical support contractor and for exchanging information with overseas nuclear safety regulators</i> . G/RES/013 Issue 02. HSE. www.hse.gov.uk/foi/internalops/nsd/research/gres013.htm
217	<i>Generic Design Assessment: AP1000 nuclear power plant design by Westinghouse Electric Company LLC</i> . Environment Agency. June 2010.
218	<i>Radioactive Substances Regulation – Environmental Principles</i> , Regulatory Guidance Series No RSR 1 Version 2. Environment Agency. April 2010.

Table 1

Relevant Safety Assessment Principles for Civil Engineering and External Hazards Considered During Step 4

SAP No.	SAP Title	Description
ECS.1	Engineering principles: safety classification and standards Safety Categorisation	The safety functions to be delivered within the facility, both during normal operation and in the event of a fault or accident, should be categorised based on their significance with regard to safety.
ECS.2	Engineering principles: safety classification and standards Safety classification of structures, systems and components	Structures, systems and components that have to deliver safety functions should be identified and classified on the basis of those functions and their significance with regard to safety.
ECS.3	Engineering principles: safety classification and standards Standards	Structures, systems and components that are important to safety should be designed, manufactured, constructed, installed, commissioned, quality assured, maintained, tested and inspected to the appropriate standards.
ECS.4	Engineering principles: safety classification and standards Codes and standards	For structures, systems and components that are important to safety, for which there are no appropriate established codes or standards, an approach derived from existing codes or standards for similar equipment, in applications with similar safety significance, may be applied.
ECS.5	Engineering principles: safety classification and standards Use of experience, tests or analysis	In the absence of applicable or relevant codes and standards, the results of experience, tests, analysis, or a combination thereof, should be applied to demonstrate that the item will perform its safety function(s) to a level commensurate with its classification.
EHA.1	Engineering principles: external and internal hazards Identification	External and internal hazards that could affect the safety of the facility should be identified and treated as events that can give rise to possible initiating faults.
EHA.3	Engineering principles: external and internal hazards Design basis events	For each internal or external hazard, which cannot be excluded on the basis of either low frequency or insignificant consequence, a design basis event should be derived.

Table 1

Relevant Safety Assessment Principles for Civil Engineering and External Hazards Considered During Step 4

SAP No.	SAP Title	Description
EHA.4	Engineering principles: external and internal hazards Frequency of exceedance	The design basis event for an internal and external hazard should conservatively have a predicted frequency of exceedance in accordance with the fault analysis requirements (FA.5).
EHA.7	Engineering principles: external and internal hazards 'Cliff-edge' effects	A small change in DBA parameters should not lead to a disproportionate increase in radiological consequences.
EHA.11	Engineering principles: external and internal hazards Extreme Weather	Nuclear facilities should withstand extreme weather conditions that meet the design basis event criteria.
EHA.12	Engineering principles: external and internal hazards Flooding	Nuclear facilities should withstand flooding conditions that meet the design basis event criteria.
ECE.1	Engineering principles: civil engineering Functional performance	The required safety functional performance of the civil engineering structures under normal operating and fault conditions should be specified.
ECE.2	Engineering principles: civil engineering Independent arguments	For structures requiring the highest levels of reliability, several related but independent arguments should be used.
ECE.3	Engineering principles: civil engineering Defects	It should be demonstrated that safety-related structures are sufficiently free of defects so that their safety functions are not compromised, that identified defects are tolerable, and that the existence of defects that could compromise their safety function can be established through their life-cycle.
ECE.4	Engineering principles: civil engineering	Investigations should be carried out to determine the suitability of the natural site materials to support the foundation loadings specified for normal operation and fault conditions.
ECE.5	Engineering principles: civil engineering	The design of foundations should utilise information derived from geotechnical site investigation.

Table 1

Relevant Safety Assessment Principles for Civil Engineering and External Hazards Considered During Step 4

SAP No.	SAP Title	Description
ECE.6	Engineering principles: civil engineering	For safety-related structures, load development and a schedule of load combinations within the design basis together with their frequency should be used as the basis for the design against operating, testing and fault conditions.
ECE.7	Engineering principles: civil engineering	The foundations should be designed to support the structural loadings specified for normal operation and fault conditions.
ECE.8	Engineering principles: civil engineering	Designs should allow key load bearing elements to be inspected and, if necessary, maintained.
ECE.9	Engineering principles: civil engineering	The design of embankments, natural and excavated slopes, river levees and sea defences close to a nuclear facility should be such so as to protect and not to jeopardise the safety of the facility.
ECE.10	Engineering principles: civil engineering	The design should be such that the facility remains stable against possible changes in the ground-water conditions.
ECE.11	Engineering principles: civil engineering	The design should take account of the possible presence of naturally occurring explosive gases or vapours in underground structures such as tunnels, trenches and basements.
ECE.12	Engineering principles: civil engineering	Structural analysis or model testing should be carried out to support the design and should demonstrate that the structure can fulfil its safety functional requirements over the lifetime of the facility.
ECE.13	Engineering principles: civil engineering	The data used in any analysis should be such that the analysis is demonstrably conservative.
ECE.14	Engineering principles: civil engineering	Studies should be carried out to determine the sensitivity of analytical results to the assumptions made, the data used, and the methods of calculation.

Table 1

Relevant Safety Assessment Principles for Civil Engineering and External Hazards Considered During Step 4

SAP No.	SAP Title	Description
ECE.15	Engineering principles: civil engineering: structural analysis and model testing Validation of methods	Where analyses have been carried out on civil structures to derive static and dynamic structural loadings for the design, the methods used should be adequately validated.
ERL.1	Engineering principles: reliability claims Form of claims	The reliability claimed for any structure, system or component important to safety should take into account its novelty, the experience relevant to its proposed environment, and the uncertainties in operating and fault conditions, physical data and design methods.
EKP.3	Engineering principles: key principles Defence in depth	A nuclear facility should be so designed and operated that defence in depth against potentially significant faults or failures is achieved by the provision of several levels of protection.
ELO.4	Engineering principles: layout Minimisation of the effects of incidents	The design and layout of the site and its facilities, the plant within a facility and support facilities and services should be such that the effects of incidents are minimised.
ESS.18	Engineering principles: safety systems Failure independence	No fault, internal or external hazard should disable a safety system.
EDR.2	Engineering principles: design for reliability Redundancy, diversity and segregation	Redundancy, diversity and segregation should be incorporated as appropriate within the designs of structures, systems and components important to safety.
DC.1	Decommissioning Design and operation	Facilities should be designed and operated so that they can be safely decommissioned.

Annex 1

Assessment Findings to Be Addressed During the Forward Programme as Normal Regulatory Business

Civil Engineering and External Hazards – AP1000

Finding No:	Assessment Finding	MILESTONE (by which this item should be addressed)
AF-AP1000-CE-01	The licensee shall ensure that all civil documentation for the AP1000 uses the same nomenclature for Seismic Class NNS – non-nuclear seismic.	2 - First concrete.
AF-AP1000-CE-02	The licensee shall confirm the safety categorisation of the radwaste building, and provide justification for this.	2 - First concrete.
AF-AP1000-CE-03	The licensee shall ensure that the relevant civil documentation for the AP1000 Class II structures is specific on which sections from which codes are used, on each structure or parts of a structure. For example, whether the strength and serviceability requirements for Class II structures are taken from ACI 349 or ACI 318. An appraisal of the sub-clauses should be performed to ensure that no rules have been breached by choosing a different construction code to the one used for design.	2 - First concrete.
AF-AP1000-CE-04	The licensee shall ensure that evidence is generated to ensure that the proposed codes and standards for the AP1000 are adequate to support design, procurement, installation, operation, and subsequent EMIT activities. The licensee should also ensure that the AP1000 codes and standards meet applicable UK Health and Safety legislation, including regulations as appropriate.	2 - First concrete.
AF-AP1000-CE-05	The licensee shall make and implement adequate arrangements to ensure that the AP1000 NPP design for the UK takes account of subsequent changes to applicable codes, standards, and legislation.	2 - First concrete.
AF-AP1000-CE-06	The licensee shall derive hazard magnitudes for those hazards identified as only capable of evaluation on a site specific basis, including external flooding, accidental aircraft crash, external explosion, offsite fire and smoke, offsite missiles, biological fouling and electromagnetic interference.	2 - First concrete.

Annex 1

**Assessment Findings to Be Addressed During the Forward Programme as Normal Regulatory Business
Civil Engineering and External Hazards – AP1000**

Finding No:	Assessment Finding	MILESTONE (by which this item should be addressed)
AF-AP1000-CE-07	The licensee shall confirm that the magnitude of all external hazards considered generically envelope those for the particular site under consideration.	2 - First concrete.
AF-AP1000-CE-08	The licensee shall confirm that, for any structure designed using generic site data, this data is enveloped for the particular site under consideration. This shall include, as a minimum, design loads and load combinations applied to the design and final detailing including proprietary items.	2 - First concrete.
AF-AP1000-CE-09	The licensee shall take account of any implications of the outcomes of the Internal Hazards GDA issues which could affect the design of civil structures, particularly the loads, load combinations and serviceability requirements applied in the design.	1 – Long lead item procurement
AF-AP1000-CE-10	The licensee shall undertake a probabilistic study of accidental aircraft impact on a site specific basis.	3 – NI safety related concrete
AF-AP1000-CE-11	Suppliers may wish to substitute the specified US standards materials with locally sourced materials. The licensee shall justify that the procedures to be adopted for material substitution are robust, such that the design integrity is not compromised.	2 - First concrete.
AF-AP1000-CE-12	The licensee shall justify that all site specific concrete mix designs comply with the generic design requirements, including self consolidating concrete.	2 - First concrete.
AF-AP1000-CE-13	The licensee shall justify that the concrete materials testing to be used for construction achieves direct correlation between test results and generic design requirements. The procedures for ensuring suitably qualified and experienced test operatives, particularly if US tests are to be adopted, shall also be justified.	2 - First concrete.

Annex 1

Assessment Findings to Be Addressed During the Forward Programme as Normal Regulatory Business

Civil Engineering and External Hazards – AP1000

Finding No:	Assessment Finding	MILESTONE (by which this item should be addressed)
AF-AP1000-CE-14	In the event that a supplier wishes to substitute US reinforcement for EN standards, the licensee shall justify that the full impact on the design of reinforced structures is properly assessed and that the safety features of the design are not compromised.	2 - First concrete.
AF-AP1000-CE-15	The licensee shall justify that the geotechnical materials and specifications to be used for the specific site application achieve the generic design requirements, as detailed in Section 2.5 of the EDCD.	2 - First concrete.
AF-AP1000-CE-16	The licensee shall ensure that the design and fabrication of all steelwork connections is carried out in accordance with the national design standards specified in the GDA design. The licensee shall also justify that the supplier's designers and operatives are suitably qualified and experienced in the use of the chosen national design standards, including weld procedures and consumables. Where the licensee proposes to change the measurement system for design and fabrication, this must be done through a formal design change process.	2 - First concrete.
AF-AP1000-CE-17	The AP1000 generic design is based on all reinforcement detailing being carried out in accordance with the US standards specified in the GDA design. The licensee shall justify that the UK local suppliers used for RC detailing has the appropriate competence in this regard.	2 - First concrete.
AF-AP1000-CE-18	: The licensee shall justify that the site specific FE analyses adequately model the potential rocking of the nuclear island. The Level 2 analyses used to calculate the force and displacement demand shall be compared with the Level 1 analyses to demonstrate rocking has been included. Specific comparison shall be made of forces and displacements at the top of the building.	2 - First concrete.
AF-AP1000-CE-19	The licensee shall justify that the site specific FE analyses include an assessment of accidental torsion on the nuclear island model in accordance with the requirements of ASCE 4.	2 - First concrete.

Annex 1

Assessment Findings to Be Addressed During the Forward Programme as Normal Regulatory Business

Civil Engineering and External Hazards – AP1000

Finding No:	Assessment Finding	MILESTONE (by which this item should be addressed)
AF-AP1000-CE-20	The licensee shall update the seismic analysis and design methodology documents to confirm which code has been used for the non-nuclear seismic class; UBC1997 or IBC 2009.	2 - First concrete.
AF-AP1000-CE-21	The licensee shall substantiate that the site specify design for non-nuclear seismic class buildings, accounts for the prevention of disproportional collapse in line with UK Building Regulations 2000 2000 or version current at that time.	2 - First concrete.
AF-AP1000-CE-22	The licensee shall revise the Civil/Structural Design Criteria document to state which ASCE 4-98 method they have used, i.e. the impedance method or the direct method. The licensee shall correctly describe in the same document how the soil is modelled by the method adopted.	2 - First concrete.
AF-AP1000-CE-23	The licensee shall carry out the soil structure interaction analyses (Level 1) for the specific site application and shall apply the input spectra at the location that is appropriate for the type of spectra, i.e. for free field site specific soil spectra it is appropriate to apply at the ground level.	2 - First concrete.
AF-AP1000-CE-24	The licensee shall demonstrate that the nuclear island response spectra resulting from the SSI analyses are bounded by the generic spectra or carry out re-analysis work to ascertain the new seismic demands and check the structural design against these.	2 - First concrete.
AF-AP1000-CE-25	Following the site specific soil structure interaction analysis, the licensee shall justify that the resulting floor response spectra are bounded by the generic spectra. If they are not, then the equipment/component qualification must be revisited and justified.	2 - First concrete.
AF-AP1000-CE-26	The licensee must justify using the NI-20 model in its site specific SSI model by performing a mesh sensitivity verification, which includes soil impedance functions.	2 - First concrete.

Annex 1

**Assessment Findings to Be Addressed During the Forward Programme as Normal Regulatory Business
Civil Engineering and External Hazards – AP1000**

Finding No:	Assessment Finding	MILESTONE (by which this item should be addressed)
AF-AP1000-CE-27	The licensee shall justify the soil structure interaction (SSI) analyses for the interaction between buildings for the specific site application. Where 2D analyses are used, the licensee shall justify that these adequately model the interactions between adjacent buildings for the ground strata for that site, particularly where one foundation imposes overburden pressures on an adjacent below ground structure or affects settlement interactions. The isolation gaps between foundations and superstructures, provided in the generic design, must be justified or recalculated. This shall also include interaction between distinct parts of buildings on common foundations, such as the Turbine Building first bay and main structure.	2 - First concrete.
AF-AP1000-CE-28	The licensee shall provide details of the building movement joints between the Nuclear Island and adjacent structures in terms of their effectiveness, practicability and longevity. This shall also include justification that plants and services passing over the building movement joints can accommodate the relative movement predicted.	2 - First concrete.
AF-AP1000-CE-29	The licensee shall justify that the performance of NNS buildings under the C-I seismic event, i.e. SSE will not adversely affect the performance of C-I structures. Consideration shall be given to potential collapse of NNS structures, either directly onto C-I structures or causing collapse of C-II structures onto C-I structures. Consideration shall also be given to collapse of NNS structures preventing appropriate access on the site to the safety systems required for safe shutdown.	2 - First concrete.
AF-AP1000-CE-30	The licensee shall carry out the NI raft foundation structural analyses with the correct site characteristics (e.g. soil strata, groundwater level and maximum site flood level) for the specific site application and justify the design of the raft.	2 - First concrete.

Annex 1

Assessment Findings to Be Addressed During the Forward Programme as Normal Regulatory Business

Civil Engineering and External Hazards – AP1000

Finding No:	Assessment Finding	MILESTONE (by which this item should be addressed)
AF-AP1000-CE-31	The licensee shall justify that the generic factors of safety for sliding, overturning and uplift on the nuclear island foundation are still applicable for the site specific soil properties. Where the site specific soil properties are not bounded by the standard plant soil properties, the factors of safety shall be re-substantiated. The use of passive earth pressure on the sides of foundations in calculating resistance to sliding shall be justified or alternative calculation produced.	2 - First concrete.
AF-AP1000-CE-32	The licensee shall demonstrate that for the specific site application, the soil characteristics are bounded by the two differential settlement analyses described in Section 16.14.5 of the PCSR. In the event that bounding cannot be demonstrated, or where the strata are not horizontal, differential settlement shall be re-analysed with the appropriate FE model. The forces in the raft and members due to out of sequence construction shall be recalculated and the restrictions on the relative rates of construction of the Shield Building and Auxiliary Building shall be re-determined. The raft reinforcement design shall be revised accordingly.	2 - First concrete.
AF-AP1000-CE-33	The licensee shall justify that the proposed procedures for settlement monitoring and assessment of construction progress comply with the design settlement analyses.	2 - First concrete.
AF-AP1000-CE-34	The licensee shall justify that the waterproofing product, selected for the underside of the nuclear island foundation raft, provides adequate shear strength to transfer horizontal shear forces due to seismic (SSE) loading. This function is seismic Category I. The licensee shall provide details of the waterproof membrane for safety critical structures in terms of its effectiveness, practicability and longevity.	2 - First concrete.
AF-AP1000-CE-35	The licensee shall justify that the design of site roads and hard standings does not lead to ponding of surface water, such that it rises above the maximum flood level claimed.	3 - Nuclear island safety related concrete

Annex 1

Assessment Findings to Be Addressed During the Forward Programme as Normal Regulatory Business

Civil Engineering and External Hazards – AP1000

Finding No:	Assessment Finding	MILESTONE (by which this item should be addressed)
AF-AP1000-CE-36	The licensee shall justify that the proposed form of excavation for the nuclear island raft and basement, is bounded by the design as stated in section 2.5 of the EDCD. In the event that bounding cannot be demonstrated, then 1) the effect of backfill and soil properties on the seismic analyses shall be determined and if necessary shall be re-analysed with the appropriate FE model; 2) all consequential effects from this re-analysis shall be included in the final design, including factors of safety for sliding, and the effect on the design of the basement walls from lateral earth pressures.	3 - Nuclear island safety related concrete
AF-AP1000-CE-37	The licensee shall justify that the proposed method of construction of the basement walls allows for post construction inspection and remediation of potential defects in the concrete wall and the external waterproofing. For instance, the protection measures to be used to prevent damage to the waterproofing from concreting works or backfilling as appropriate.	3 - Nuclear island safety related concrete
AF-AP1000-CE-38	The licensee shall provide the final details for the water tight seal between upper annulus and lower annulus of the Shield Building in terms of its effectiveness, practicality and longevity. The licensee shall justify that the seal detail will satisfy the safety functions of preventing water ingress into the middle annulus and that it can and will be maintained appropriately.	3 - Nuclear island safety related concrete
AF-AP1000-CE-39	The licensee shall provide the final detail for the water tight seal between the concrete structure and the containment vessel in terms of its effectiveness, practicality and longevity. The licensee shall justify that the seal detail will satisfy the safety functions of preventing water ingress into the joint and thus preventing corrosion of the CV. The licensee shall also justify that the joint can and will be maintained appropriately.	3 - Nuclear island safety related concrete
AF-AP1000-CE-40	The licensee shall justify that the concrete placement pressures, due to floor level differences at the base, do not overstress the CV plate in its temporary or permanent condition.	3 - Nuclear island safety related concrete

Annex 1

Assessment Findings to Be Addressed During the Forward Programme as Normal Regulatory Business

Civil Engineering and External Hazards – AP1000

Finding No:	Assessment Finding	MILESTONE (by which this item should be addressed)
AF-AP1000-CE-41	The licensee shall justify that the steelwork support grillage to the CV bottom head does not affect the integrity of the CV, particularly during installation and construction works.	3 - Nuclear island safety related concrete
AF-AP1000-CE-42	The licensee shall justify that concrete placement beneath the CV bottom head does not result in construction defects that will affect the CV plate integrity, e.g. voids in concrete must be within allowable for the plate to span over them.	3 - Nuclear island safety related concrete
AF-AP1000-CE-43	All the basement walls to the Auxiliary Building will need to be verified at site specific stage for lateral earth pressures and surcharge loading from adjacent buildings. The licensee shall justify that the site specific earth pressures are bounded by the generic design of the Auxiliary Building basement structures. Where this is not the case, the licensee shall revise the design accordingly.	2 – First concrete.
AF-AP1000-CE-44	The licensee shall justify that for the site specific seismic analysis, the compression load on the walls of the auxiliary basement from reversal of the SSE are bounded by the generic design. Where this is not the case, the licensee shall revise the design accordingly.	2 – First concrete.
AF-AP1000-CE-45	The licensee shall provide justification that the construction methods used for fabrication and erection of the CA Modules do not result in additional locked in stresses that need to be included in the final design capacity calculations (as claimed in the GDA design methodology, APP-GW-SUP-001 Revision 2).	1 – long lead item procurement
AF-AP1000-CE-46	The licensee shall provide justification that the concrete placement rate for the specific concrete mix used does not result in higher stresses in the steel faceplates than that stated in the GDA design methodology, APP-GW-SUP-001 Revision 2.	3 - Nuclear island safety related concrete

Annex 1

Assessment Findings to Be Addressed During the Forward Programme as Normal Regulatory Business

Civil Engineering and External Hazards – AP1000

Finding No:	Assessment Finding	MILESTONE (by which this item should be addressed)
AF-AP1000-CE-47	The licensee shall provide the management plan for the interfaces between different contractors involved in the positioning of the SC modules. The licensee shall also provide the detailed specifications and construction method statements for each task, with specific reference to post lifting inspection and testing to ensure no detrimental effect on the structures' design intent.	1 – long lead item procurement
AF-AP1000-CE-48	The licensee shall provide the full details of the weld procedures and testing proposed for the various SC modules at the site specific stage.	1 – long lead item procurement
AF-AP1000-CE-49	The licensee shall provide the full details of the construction methods for concreting the various SC modules at the site specific stage. The licensee shall justify that these meet the requirements of the generic design.	1 – long lead item procurement
AF-AP1000-CE-50	The licensee shall provide the full details of the weld procedures and testing proposed for the tie bars to the steel faceplates for the ESB SC cylindrical wall. These procedures must ensure that the weld is stronger than the tie bar and satisfies all the design assumptions/ requirements.	1 – long lead item procurement
AF-AP1000-CE-51	The licensee shall provide the management plan for the interfaces between different contractors involved in the positioning of the ESB SC modules. The licensee shall also provide the detailed specifications and construction method statements for each task, with specific reference to post lifting inspection and testing, to ensure no detrimental effect on the structures' design intent.	1 – long lead item procurement
AF-AP1000-CE-52	The licensee shall provide the full details of the weld procedures and testing proposed for the ESB SC modules at the site specific stage.	1 – long lead item procurement

Annex 1

Assessment Findings to Be Addressed During the Forward Programme as Normal Regulatory Business

Civil Engineering and External Hazards – AP1000

Finding No:	Assessment Finding	MILESTONE (by which this item should be addressed)
AF-AP1000-CE-53	The licensee shall provide justification that the concrete placement rate for the ESB SC wall does not induce higher stresses in the steel faceplates than that accounted for in design calculations.	3 - Nuclear island safety related concrete
AF-AP1000-CE-54	The licensee shall confirm the post concreting inspection techniques to be used for the ESB SC wall and justify that these will detect potential defects that have identified as critical to the design performance.	3 - Nuclear island safety related concrete
AF-AP1000-CE-55	The licensee shall justify that the final detail used for interface shear connectors for both ACI349 HSC floor modules and AISC N690 Composite floor modules will provide the required shear transfer to ensure composite action.	1 – long lead item procurement
AF-AP1000-CE-56	Spent Fuel Pool - The licensee shall substantiate the primary welds and the leak chase welds are high integrity. Evidence shall be submitted for specifications for weld materials and procedures. This should include quality control on materials on site, e.g. ensuring correct weld rods are used by operators, especially considering mild and stainless steel are in close proximity and testing for high integrity welds i) post fabrication and ii) post erection of CA20.	1 – long lead item procurement
AF-AP1000-CE-57	The licensee shall include in the site specific HCLPF calculation for the Shield Building SC cylindrical wall, an assessment of the different failure modes including tie bar failure, rather than basing the calculation on plate tensile strength alone.	1 – long lead item procurement
AF-AP1000-CE-58	The licensee shall justify that the site-specific horizontal Uniform Hazard Spectra (UHS), based on or corrected to be the maximum of two horizontal directions (as opposed to the geometric mean), envelopes the 0.3g pga design spectrum used in the generic design. Similarly, the site-specific vertical UHS must be shown to envelope the 0.3g pga design spectrum used in the vertical direction.	3 - Nuclear island safety related concrete

Annex 1

Assessment Findings to Be Addressed During the Forward Programme as Normal Regulatory Business

Civil Engineering and External Hazards – AP1000

Finding No:	Assessment Finding	MILESTONE (by which this item should be addressed)
AF-AP1000-CE-59	The HCLPF calculation for the in-containment SC modules considers only failure of the plates in tension. The licensee shall include in the site specific HCLPF calculation for the SC modules, an assessment of the different failure modes of the structures to find the critical failure mode and hence the true HCLPF value for these structures.	1 – long lead item procurement
AF-AP1000-CE-60	The licensee shall ensure that due consideration is given to the UK Construction (Design and Management) Regulations for the design of all civil structures (nuclear safety and non-nuclear safety structures).	2 – first concrete

Note: It is the responsibility of the Licensees / Operators to have adequate arrangements to address the Assessment Findings. Future Licensees / Operators can adopt alternative means to those indicated in the findings which give an equivalent level of safety.

For Assessment Findings relevant to the operational phase of the reactor, the Licensees / Operators must adequately address the findings during the operational phase. For other Assessment Findings, it is the regulators' expectation that the findings are adequately addressed no later than the milestones indicated above.

Annex 2

GDA Issues – Civil Engineering and External Hazards – AP1000

WESTINGHOUSE AP1000® GENERIC DESIGN ASSESSMENT

GDA ISSUE

JUSTIFICATION OF NOVEL FORM OF STRUCTURE FOR THE STEEL/ CONCRETE
COMPOSITE WALLS AND FLOORS KNOWN AS CA MODULES

GI-AP1000-CE-01 REVISION 0

Technical Area		CIVIL ENGINEERING	
Related Technical Areas		None	
GDA Issue Reference	GI-AP1000-CE-01	GDA Issue Action Reference	GI-AP1000-CE-01.A1
GDA Issue	Definition and justification of the novel design used for the steel/concrete composite system proposed for the CA Modules within the nuclear island.		
GDA Issue Action	<p>CONSOLIDATED SET OF DESIGN DOCUMENTS</p> <p>The current set of documents submitted by Westinghouse range from high level documents to TQ responses. The UK Regulator requires a consolidated set of documentation to adequately describe the structure that is the basis of Westinghouse's submission under the GDA process. This is to ensure any changes made after an iDAC/DAC is issued are easily identifiable.</p> <p>This action requires Westinghouse to provide a consolidated set of formal documents that explicitly define the design submission. This should include, but not necessarily be limited to the following:</p> <ul style="list-style-type: none"> • A single overarching document that summarises the structure submitted and the design methodology used for the UK GDA submission. This should draw together all the various submissions on the design methodology for the CA Modules that have been submitted under GDA Step 4, and should include the UK Regulator additional requirements.. • A document map and a list of the complete set of formal documents that define the structural layout, materials, form, the design methodology and the substantiation /calculations for the CA Modules. • Adequate responses to any questions arising from assessment by ONR of documents submitted at the end of GDA Step 4 but not reviewed in detail at that time. • Sufficient drawings/mark ups to describe the structural layout and form of the CA Modules submitted under GDA. <p>With agreement from the Regulator this action may be completed by alternative means.</p>		

Annex 2

WESTINGHOUSE AP1000® GENERIC DESIGN ASSESSMENT

GDA ISSUE

JUSTIFICATION OF NOVEL FORM OF STRUCTURE FOR THE STEEL/ CONCRETE
COMPOSITE WALLS AND FLOORS KNOWN AS CA MODULES

GI-AP1000-CE-01 REVISION 0

Technical Area		CIVIL ENGINEERING	
Related Technical Areas		None	
GDA Issue Reference	GI-AP1000-CE-01	GDA Issue Action Reference	GI-AP1000-CE-01.A2
GDA Issue Action	<p>ADDITIONAL ACCEPTANCE CRITERIA FOR OUT OF PLANE SHEAR CAPACITY</p> <p>For the current demand versus capacity utilisations for the majority of locations, the design method used is acceptable but is not universally applicable for higher utilisations. Therefore, additional limitations/acceptance criteria must be included in the GDA design methodology to limit the level of utilisation.</p> <p>This action requires Wesinghouse to provide additional acceptance criteria for the proposed design methodology to ACI 349-01 for out of plane shear, which shall include, but not be limited to, the following:</p> <ul style="list-style-type: none"> • A reduction in the design value for V_c for the concrete contribution to shear strength, below the allowable value in ACI 349-01. Justification should be provided for the chosen limit of V_c. • Confirm the limit on V_c, above which shear reinforcement will be added (as stated in APP-GW-SUP-001) and provide design substantiation for the reinforcement provided. <p>The key design methodology document must therefore clearly state that this margin should not be encroached upon by future design development or changes.</p> <p>With agreement from the Regulator this action may be completed by alternative means.</p>		

Annex 2

WESTINGHOUSE AP1000® GENERIC DESIGN ASSESSMENT

GDA ISSUE

JUSTIFICATION OF NOVEL FORM OF STRUCTURE FOR THE STEEL/ CONCRETE
COMPOSITE WALLS AND FLOORS KNOWN AS CA MODULES

GI-AP1000-CE-01 REVISION 0

Technical Area		CIVIL ENGINEERING	
Related Technical Areas		None	
GDA Issue Reference	GI-AP1000-CE-01	GDA Issue Action Reference	GI-AP1000-CE-01.A3
GDA Issue Action	<p>ADDITIONAL ACCEPTANCE CRITERIA FOR IN-PLANE SHEAR CAPACITY WHEN CONSIDERED WITH OTHER LOADS</p> <p>The current demand versus capacity utilisations, the design method used is acceptable but, it is not universally applicable to combinations of high in-plane shear, moment and axial load. Therefore, additional limitations/acceptance criteria must be included in the GDA design methodology.</p> <p>This action requires Westinghouse to provide additional justification for the proposed design methodology for in-plane shear when combined with other loads, as follows:</p> <p>1) Provide further calculations for in-plane shear to alternative codes:</p> <ul style="list-style-type: none"> • JEAG 4618 • draft AISC N690 App N9 • any others deemed applicable by Westinghouse, including first principles. <p>in order to justify that the plates still have sufficient margin above the demand levels when these codes are used for design.</p> <p>These calculations should consider all the coincident loads present for each critical loadcase, such as those described in other actions of this pGI. These calculations should also include the symmetric sharing of in plane shear stress used by these codes.</p> <p>2) Following the above, provide the limitations on combined loadings (e.g. moment and axial load) for which the Westinghouse methodology of asymmetric sharing of in-plane shear stress is applicable.</p> <p>With agreement from the Regulator this action may be completed by alternative means.</p>		

Annex 2

WESTINGHOUSE AP1000® GENERIC DESIGN ASSESSMENT

GDA ISSUE

JUSTIFICATION OF NOVEL FORM OF STRUCTURE FOR THE STEEL/ CONCRETE COMPOSITE WALLS AND FLOORS KNOWN AS CA MODULES

GI-AP1000-CE-01 REVISION 0

Technical Area		CIVIL ENGINEERING	
Related Technical Areas		None	
GDA Issue Reference	GI-AP1000-CE-01	GDA Issue Action Reference	GI-AP1000-CE-01.A4
GDA Issue Action	<p>ADDITIONAL SUBSTANTIATION OF SHEAR CONNECTION</p> <p>Provide the following substantiation with respect to the shear connectors:</p> <ul style="list-style-type: none"> Justify that the strength reduction factor of 0.75 for shear studs taken from ACI 349-01 B.4.4 is appropriate and provide sensitivity of this. Justify the 125kips capacity for the channel acting as a shear lug, calculated to B.4.5.2 of ACI 349-01. Also justify the length of the channel (8inches) used in calculating the bearing onto the concrete. Justification for omission of any tension force in the shear studs (resulting from restraining the plate) is required, and, if a tension force is required, the effect on the stud shear capacity needs to be considered. Provide calculations for the development length to justify the shear for the full range of wall thicknesses and incorporating the outcomes of the above. If the development length is smaller than the lesser of three times the wall thickness or 9 feet, a first-principles approach that considers shear flow and locally applied forces in the horizontal and vertical direction may be acceptable. <p>With agreement from the Regulator this action may be completed by alternative means.</p>		

Annex 2

WESTINGHOUSE AP1000® GENERIC DESIGN ASSESSMENT**GDA ISSUE****JUSTIFICATION OF NOVEL FORM OF STRUCTURE FOR THE STEEL/ CONCRETE
COMPOSITE WALLS AND FLOORS KNOWN AS CA MODULES****GI-AP1000-CE-01 REVISION 0**

Technical Area		CIVIL ENGINEERING	
Related Technical Areas		None	
GDA Issue Reference	GI-AP1000-CE-01	GDA Issue Action Reference	GI-AP1000-CE-01.A5
GDA Issue Action	<p>JUSTIFICATION OF CONNECTIONS FOR CA MODULES</p> <p>Westinghouse is required to submit the final concept details for a sample of generic connections for the CA Modules. This should include detail drawings and calculations. The calculations should clearly state the failure mechanisms of the connections considered and the effects on the ductile behaviour of the whole structure.</p> <p>With agreement from the Regulator this action may be completed by alternative means.</p>		

Annex 2

WESTINGHOUSE AP1000® GENERIC DESIGN ASSESSMENT

GDA ISSUE

JUSTIFICATION OF NOVEL FORM OF STRUCTURE FOR THE STEEL/ CONCRETE
COMPOSITE WALLS AND FLOORS KNOWN AS CA MODULES

GI-AP1000-CE-01 REVISION 0

Technical Area		CIVIL ENGINEERING	
Related Technical Areas		None	
GDA Issue Reference	GI-AP1000-CE-01	GDA Issue Action Reference	GI-AP1000-CE-01.A6
GDA Issue Action	<p>JUSTIFICATION OF THE ABILITY OF SC TO WITHSTAND THERMAL LOADCASE</p> <p>Westinghouse is required to justify how the thermal analysis models transient thermal effects, such as environmentally induced transients and how these are combined with other mechanical loads in the design load cases.</p> <p>Westinghouse is also required to provide further justification that vapour pressure within the CA Modules resulting from high thermal loading will not affect the structure's ability to perform its safety function (refer to action A7).</p> <p>With agreement from the Regulator this action may be completed by alternative means.</p>		

Annex 2

WESTINGHOUSE AP1000® GENERIC DESIGN ASSESSMENT

GDA ISSUE

JUSTIFICATION OF NOVEL FORM OF STRUCTURE FOR THE STEEL/ CONCRETE
COMPOSITE WALLS AND FLOORS KNOWN AS CA MODULES

GI-AP1000-CE-01 REVISION 0

Technical Area		CIVIL ENGINEERING	
Related Technical Areas		None	
GDA Issue Reference	GI-AP1000-CE-01	GDA Issue Action Reference	GI-AP1000-CE-01.A7
GDA Issue Action	<p>JUSTIFICATION OF THE ABILITY OF SC TO WITHSTAND FIRE</p> <p>Westinghouse is required to provide evidence on the effect of fire on the CA Modules generally, not only where they are claimed as fire barriers.</p> <p>The effect of fire on the CA Modules needs to be quantified, such that the risk to structures supporting Category 1 nuclear safety plant can be assessed, Specifically:</p> <ul style="list-style-type: none"> • Loss of the faceplate – the level of fire that will achieve this and the resulting effect on the load carrying capacity of the remaining structure need to be quantified. • Build up of vapour pressure inside the wall due to fire. Westinghouse considers this a local effect but ONR believes this is not the case for a full room burn. • Overall response of the whole structure to the temperatures in the fire, i.e. combination of induced thermal moment with other loads and deflections. <p>The response to GI-AP1000-IH.1.A1 will be key in answering the above. However, IH.1.A1 specifically refers to walls and floor claimed as fire barriers. This action is concerned with the structural stability of all the CA Modules following a potential fire. Therefore, a quantification of the fire magnitude that the structure can withstand without structural collapse shall be provided.</p> <p>With agreement from the Regulator this action may be completed by alternative means.</p>		

Annex 2

WESTINGHOUSE AP1000® GENERIC DESIGN ASSESSMENT

GDA ISSUE

JUSTIFICATION OF NOVEL FORM OF STRUCTURE FOR THE STEEL/ CONCRETE
COMPOSITE WALLS AND FLOORS KNOWN AS CA MODULES

GI-AP1000-CE-01 REVISION 0

Technical Area		CIVIL ENGINEERING	
Related Technical Areas		None	
GDA Issue Reference	GI-AP1000-CE-01	GDA Issue Action Reference	GI-AP1000-CE-01.A8
GDA Issue Action	<p>LONG TERM RELIABILITY</p> <p>Westinghouse is required to provide further substantiation on the long term reliability as follows:</p> <ul style="list-style-type: none"> • Provide details of similar structures in use on nuclear power stations, including construction provisions, design methodologies adopted and operational performance. • Assess the effects on the calculation of HCLPF for the in-containment CA Modules, based on the completion of actions A2 to A4 of this GDA Issue. • Provide any other relevant reliability calculations, e.g. similar to Eurocodes. <p>With agreement from the Regulator this action may be completed by alternative means.</p>		

Annex 2

WESTINGHOUSE AP1000® GENERIC DESIGN ASSESSMENT

GDA ISSUE

FURTHER JUSTIFICATION OF NOVEL FORM OF STRUCTURE FOR THE STEEL/ CONCRETE
COMPOSITE WALL TO THE ENHANCED SHIELD BUILDING

GI-AP1000-CE-02 REVISION 0

Technical Area		CIVIL ENGINEERING	
Related Technical Areas		Internal Hazards PSA	
GDA Issue Reference	GI-AP1000-CE-02	GDA Issue Action Reference	GI-AP1000-CE-02.A1
GDA Issue	Further justification of the novel design used for the steel/concrete composite wall proposed for the Enhanced Shield Building within the nuclear island.		
GDA Issue Action	<p>Provide further justification on the steel material used for the tie bars in the SC wall of the ESB.</p> <p>The tie bar material specified by Westinghouse to A496 does not appear to comply with the normal European requirements for reinforcement in seismic design specifically with respect to its ductility. It is the Regulator's view that more appropriate steel grades should be considered. Westinghouse must therefore either propose a more suitable grade or provide justification why the A496 material specified is appropriate to use as shear reinforcement in seismic design taking into account European expectations for seismic design.</p> <p>With agreement from the Regulator this action may be completed by alternative means.</p>		

Annex 2

WESTINGHOUSE AP1000® GENERIC DESIGN ASSESSMENT

GDA ISSUE

FURTHER JUSTIFICATION OF NOVEL FORM OF STRUCTURE FOR THE STEEL/ CONCRETE
COMPOSITE WALL TO THE ENHANCED SHIELD BUILDING

GI-AP1000-CE-02 REVISION 0

Technical Area		CIVIL ENGINEERING	
Related Technical Areas		Internal Hazards PSA	
GDA Issue Reference	GI-AP1000-CE-02	GDA Issue Action Reference	GI-AP1000-CE-02.A2
GDA Issue	Further justification of the novel design used for the steel/concrete composite wall proposed for the Enhanced Shield Building within the nuclear island.		
GDA Issue Action	Provide further substantiation of the demand calculations for the tie bars to justify: <ul style="list-style-type: none"> • the total demand tensile force in the ties from simultaneous loads, including secondary effects. • the combination of tensile forces calculated in a) with simultaneous shear forces calculated under Action A5. • justification of the combined tensile strength and shear strength of the tie bars (tensile strength to be confirmed under Action A1. Shear strength to be confirmed under Action A5, Item 2). • provide demand versus capacity ratios. With agreement from the Regulator this action may be completed by alternative means.		

Annex 2

WESTINGHOUSE AP1000® GENERIC DESIGN ASSESSMENT

GDA ISSUE

FURTHER JUSTIFICATION OF NOVEL FORM OF STRUCTURE FOR THE STEEL/ CONCRETE
COMPOSITE WALL TO THE ENHANCED SHIELD BUILDING

GI-AP1000-CE-02 REVISION 0

Technical Area		CIVIL ENGINEERING	
Related Technical Areas		None	
GDA Issue Reference	GI-AP1000-CE-02	GDA Issue Action Reference	GI-AP1000-CE-02.A3
GDA Issue Action	<p>Provide a clear statement in the methodology that the out of plane shear is taken on the reinforcement alone.</p> <p>Provide a comparison of the proposed ACI 349-01 design methodology for out of plane shear and provision of shear reinforcement with alternative codes.</p> <p>Provide further calculations to alternative codes:</p> <ul style="list-style-type: none"> • JEAG 4618. • Draft AISC N690 App N9. • Any others deemed applicable by Westinghouse, including first principles. <p>in order to justify that the provision of ties as shear reinforcement in the ESB SC wall.</p> <p>With agreement from the Regulator this action may be completed by alternative means.</p>		

Annex 2

WESTINGHOUSE AP1000® GENERIC DESIGN ASSESSMENT

GDA ISSUE

FURTHER JUSTIFICATION OF NOVEL FORM OF STRUCTURE FOR THE STEEL/ CONCRETE
COMPOSITE WALL TO THE ENHANCED SHIELD BUILDING

GI-AP1000-CE-02 REVISION 0

Technical Area		CIVIL ENGINEERING	
Related Technical Areas		None	
GDA Issue Reference	GI-AP1000-CE-02	GDA Issue Action Reference	GI-AP1000-CE-02.A4
GDA Issue Action	<p>Provide additional justification for the proposed design methodology for in-plane shear when combined with other loads.</p> <p>Provide further calculations for in-plane shear to alternative codes:</p> <ul style="list-style-type: none"> • JEAG 4618. • Draft AISC N690 App N9. • Any others deemed applicable by Westinghouse, including first principles. <p>in order to justify that the plates still have sufficient margin above the demand levels when these codes are used for design.</p> <p>These calculations should consider all the coincident loads present for each critical loadcase, such as those described in actions A1 and A4 of this GDA Issue. These calculations should also include the symmetric sharing of in plane shear stress used by these codes.</p> <p>Following the above, provide the limitations on combined loadings (e.g. moment and axial load) for which the Westinghouse methodology of asymmetric sharing of in-plane shear stress is applicable.</p> <p>With agreement from the Regulator this action may be completed by alternative means.</p>		

Annex 2

WESTINGHOUSE AP1000® GENERIC DESIGN ASSESSMENT

GDA ISSUE

FURTHER JUSTIFICATION OF NOVEL FORM OF STRUCTURE FOR THE STEEL/ CONCRETE
COMPOSITE WALL TO THE ENHANCED SHIELD BUILDING

GI-AP1000-CE-02 REVISION 0

Technical Area		CIVIL ENGINEERING	
Related Technical Areas		None	
GDA Issue Reference	GI-AP1000-CE-02	GDA Issue Action Reference	GI-AP1000-CE-02.A5
GDA Issue Action	<p>The adequacy of the shear connection between the face plates and the concrete needs to be verified for the general areas and the connection zones.</p> <ul style="list-style-type: none"> • Provide the following substantiation with respect to the shear connectors: • Justify that the strength reduction factor of 0.75 for shear studs taken from ACI 349-01 B.4.4 is appropriate and provide sensitivity of this. (This is an identical action to GI-AP1000-CE-01.A7 item 1). • Justify the nominal and design shear capacity for the tie bars. This is to be used in the capacity calculation in Action A1 of this GDA Issue. • Justification for omission of any tension force in the shear studs (resulting from restraining the plate in compression) is required, and, if a tension force is required, the effect on the stud shear capacity needs to be considered. • Provide calculations to justify that the development length will be satisfied for the re-calculated shear resistance of the ties and studs. <p>With agreement from the Regulator this action may be completed by alternative means.</p>		

Annex 2

WESTINGHOUSE AP1000® GENERIC DESIGN ASSESSMENT

GDA ISSUE

FURTHER JUSTIFICATION OF NOVEL FORM OF STRUCTURE FOR THE STEEL/ CONCRETE COMPOSITE WALL TO THE ENHANCED SHIELD BUILDING

GI-AP1000-CE-02 REVISION 0

Technical Area		CIVIL ENGINEERING	
Related Technical Areas		None	
GDA Issue Reference	GI-AP1000-CE-02	GDA Issue Action Reference	GI-AP1000-CE-02.A6
GDA Issue Action	Westinghouse shall provide further justification for: <ul style="list-style-type: none"> • The base connection of the ESB to the RC wall below. • The connection between the Auxiliary Building roof and the ESB. • The calculation of stresses at the transition from the typical 3ft wall to the 4.5ft wall at the air inlet region, and the justification that the tie bar arrangement is sufficient to provide a competent transition. With agreement from the Regulator this action may be completed by alternative means.		

Annex 2

WESTINGHOUSE AP1000® GENERIC DESIGN ASSESSMENT

GDA ISSUE

FURTHER JUSTIFICATION OF NOVEL FORM OF STRUCTURE FOR THE STEEL/ CONCRETE COMPOSITE WALL TO THE ENHANCED SHIELD BUILDING

GI-AP1000-CE-02 REVISION 0

Technical Area		CIVIL ENGINEERING	
Related Technical Areas		None	
GDA Issue Reference	GI-AP1000-CE-02	GDA Issue Action Reference	GI-AP1000-CE-02.A7
GDA Issue Action	<p>Westinghouse is required to justify how the thermal analysis models transient thermal effects, such as environmentally induced transients.</p> <p>Justification should be provided that the plate and shear connector design will provide margin over the demand for the thermal loadcases. The concern is that frequent/daily thermal cycles could lead to cyclic forces on shear connections adjacent to cracks and degrade their capacity. The restraint forces in the studs/ties induced by restraining the compression plate against expansion must also be included in Actions A1 and A4.</p> <p>With agreement from the Regulator this action may be completed by alternative means.</p>		

Annex 2

WESTINGHOUSE AP1000® GENERIC DESIGN ASSESSMENT

GDA ISSUE

FURTHER JUSTIFICATION OF NOVEL FORM OF STRUCTURE FOR THE STEEL/ CONCRETE
COMPOSITE WALL TO THE ENHANCED SHIELD BUILDING

GI-AP1000-CE-02 REVISION 0

Technical Area		CIVIL ENGINEERING	
Related Technical Areas		None	
GDA Issue Reference	GI-AP1000-CE-02	GDA Issue Action Reference	GI-AP1000-CE-02.A8
GDA Issue Action	<p>Westinghouse is required to provide evidence on the effect of fire on the ESB SC wall generally. It is not claimed as a fire barrier.</p> <p>Westinghouse is also required to consider if vapour pressure within the ESB SC wall is a concern.</p> <p>This action is concerned with the structural stability of the ESB circular SC wall following a potential fire. Therefore, a quantification of the fire magnitude that the structure can withstand without structural collapse shall be provided. This should include possible fires outside the building and internal fires within the shield building annulus or in the auxiliary building adjacent to RC/SC connections.</p> <p>With agreement from the Regulator this action may be completed by alternative means.</p>		

Annex 2

WESTINGHOUSE AP1000® GENERIC DESIGN ASSESSMENT

GDA ISSUE

FURTHER JUSTIFICATION OF NOVEL FORM OF STRUCTURE FOR THE STEEL/ CONCRETE
COMPOSITE WALL TO THE ENHANCED SHIELD BUILDING

GI-AP1000-CE-02 REVISION 0

Technical Area		CIVIL ENGINEERING	
Related Technical Areas		None	
GDA Issue Reference	GI-AP1000-CE-02	GDA Issue Action Reference	GI-AP1000-CE-02.A9
GDA Issue Action	<p>Westinghouse is required to provide further substantiation on the reliability of the Enhanced Shield Building as follows:</p> <ul style="list-style-type: none"> • Clearly identify the target reliability expected from the design of Class 1 and Seismic Class 1 civil structures which are SC modules. • Demonstrate that the reliabilities identified in A1 above can be provided using the design methodologies adopted. This demonstration can be undertaken using whatever methods are seen as appropriate, however the following should be addressed: <ul style="list-style-type: none"> - Reliability of the Code in terms of mechanistic representation of structural behaviour. - Assumptions over the reliability of the engineer using the code. - Suitability of partial safety factors adopted in the design for both materials and loads. - Comparison with other codes for Nuclear Work. - Assumptions over the quality of materials/ construction. - Assumptions made over the long term behaviour of materials. - Assumptions made over the probability of the loadings used in the design. • Assess the effects on the calculation of HCLPF for the ESB SC wall based on the completion of actions A1 to A7 of this GDA Issue. <p>With agreement from the Regulator this action may be completed by alternative means.</p>		

Annex 2

WESTINGHOUSE AP1000® GENERIC DESIGN ASSESSMENT

GDA ISSUE

MATERIALS – AP1000 MATERIAL STANDARDS AND MATERIAL SPECIFICATIONS

GI-AP1000-CE-03 REVISION 0

Technical Area		CIVIL ENGINEERING	
Related Technical Areas		None	
GDA Issue Reference	GI-AP1000-CE-03	GDA Issue Action Reference	GI-AP1000-CE-03.A1
GDA Issue	Justification that materials adopted on the AP1000 are compatible for what would normally be expected for European construction. Clear statement on procedures for accepting suppliers proposals for material substitution of European materials for the US materials specified in the AP1000 design.		
GDA Issue Action	<p>STEEL PLATE MATERIALS</p> <p>The specific material properties listed below must be added into the material specifications to be used in the construction.</p> <ul style="list-style-type: none"> • Steel plate US standards ASTM A572, A588 cover certain steel grades and thicknesses. Identify which standards will be used and explain their applicability and suitability in situations where steel plate is to be used outside of the range covered by proposed standards. • It is usual practice in Europe to specify maximum values of yield and tensile strengths and the ratio of yield to tensile. This is to ensure appropriate ductile behaviour. As ASTM 572 does not specify maximum strengths, define the maximum strengths to be specified as additional clauses to US steel standards A572, Duplex 2101 etc. This may be done on a structure by structure basis depending on the ductile performance required. • Justify the environment is appropriate for the performance of ASTM A588 in all locations where it is to be used. • Specify the Charpy V notch impact tests for all steels. <p>With agreement from the Regulator this action may be completed by alternative means.</p>		

Annex 2

WESTINGHOUSE AP1000® GENERIC DESIGN ASSESSMENT

GDA ISSUE

MATERIALS – AP1000 MATERIAL STANDARDS AND MATERIAL SPECIFICATIONS

GI-AP1000-CE-03 REVISION 0

Technical Area		CIVIL ENGINEERING	
Related Technical Areas		None	
GDA Issue Reference	GI-AP1000-CE-03	GDA Issue Action Reference	GI-AP1000-CE-03.A2
GDA Issue Action	<p>CONCRETE MATERIALS</p> <p>The AP1000 specification for safety related mixing and delivering concrete is stated in document number APP-CC01-Z0-026.</p> <p>Westinghouse shall provide ongoing support to ONR, and provide any supplementary evidence as appropriate, to justify that the concrete materials specification does not compromise the structural design intent.</p> <p>With agreement from the Regulator this action may be completed by alternative means.</p>		

Annex 2

WESTINGHOUSE AP1000® GENERIC DESIGN ASSESSMENT

GDA ISSUE

FUEL HANDLING AREA – SECONDARY CONTAINMENT LEAK DETECTION AND COLLECTION SYSTEM

GI-AP1000-CE-04 REVISION 0

Technical Area		CIVIL ENGINEERING	
Related Technical Areas		Fault Studies Environment Agency Control & Instrumentation Radioactive Waste & Decommissioning	
GDA Issue Reference	GI-AP1000-CE-04	GDA Issue Action Reference	GI-AP1000-CE-04.A1
GDA Issue	<p>Justification that the civil structures which retain pool water in the fuel handling area of the auxiliary building have secondary containment which each have their own dedicated system to detect potential leakage and allow collection of that leakage.</p> <p>Civil pool structures that are required to contain plant water must employ multiple barriers. The numbers of barriers are dependent on the radiological hazard, but the UK Regulator expects in a modern design that at least two barriers would be provided for a spent fuel pool to achieve defence in depth.</p> <p>This GDA Issue is concerned with minor leakage from the pools in the fuel handling area that may be undetected for a period of time. This type of leak has the potential to damage the internal structure of the CA structural modules, but also to eventually migrate to the external environment. The main concern is that these potential leakage paths would go undetected for a long period of time (chronic leaks), and the extent of the resulting damage/contamination, if finally detected, would not be quantifiable.</p>		
GDA Issue Action	<p>Secondary Containment Leak Detection And Collection System for Module CA20 SC Walls and HSC Floors</p> <p>Provide a leak detection/collection system to the secondary barrier formed by the CA steel-concrete composite construction which will:</p> <ul style="list-style-type: none"> • Allow potential leaks into the structure to be detected and monitored. • Collect the potential leakage and divert it away from the significant mild steel components of the CA module. • Protect against migration of potential leaks into the base slab below. <p>With agreement from the Regulator this action may be completed by alternative means.</p>		

Annex 2

WESTINGHOUSE AP1000® GENERIC DESIGN ASSESSMENT

GDA ISSUE

FUEL HANDLING AREA – SECONDARY CONTAINMENT LEAK DETECTION AND
COLLECTION SYSTEM

GI-AP1000-CE-04 REVISION 0

Technical Area		CIVIL ENGINEERING	
Related Technical Areas		Fault Studies Environment Agency	
GDA Issue Reference	GI-AP1000-CE-04	GDA Issue Action Reference	GI-AP1000-CE-04.A2
GDA Issue Action	<p>Secondary Containment Leak Detection And Collection System for West RC wall to Transfer Canal</p> <p>Provide a leak detection/collection system to the secondary barrier formed by the RC wall which is cast up against the single plate stainless steel liner to the west wall of module CA20. This should include:</p> <ul style="list-style-type: none"> • Method to detect leakage through the RC wall, both above and below ground. • Collect the potential leakage, and thus protect against migration of potential leaks into the ground. <p>With agreement from the Regulator this action may be completed by alternative means.</p>		

Annex 2

WESTINGHOUSE AP1000® GENERIC DESIGN ASSESSMENT

GDA ISSUE

FUEL HANDLING AREA – SECONDARY CONTAINMENT LEAK DETECTION AND
COLLECTION SYSTEM

GI-AP1000-CE-04 REVISION 0

Technical Area		CIVIL ENGINEERING	
Related Technical Areas		Fault Studies Environment Agency	
GDA Issue Reference	GI-AP1000-CE-04	GDA Issue Action Reference	GI-AP1000-CE-04.A3
GDA Issue Action	<p>Secondary containment leak detection and collection system for north wall of spent fuel pool</p> <p>Provide a leak detection/collection system to the secondary barrier formed by the RC wall which is cast between the north single plate stainless steel liner of the spent fuel pool and the shield building. This should include:</p> <ul style="list-style-type: none"> • Method to detect leakage through/into the wall. • Collect the potential leakage, and thus protect against migration of potential leaks into the ground. <p>With agreement from the Regulator this action may be completed by alternative means.</p>		

Annex 2

WESTINGHOUSE AP1000® GENERIC DESIGN ASSESSMENT

GDA ISSUE

FUEL HANDLING AREA – SECONDARY CONTAINMENT LEAK DETECTION AND
COLLECTION SYSTEM

GI-AP1000-CE-04 REVISION 0

Technical Area		CIVIL ENGINEERING	
Related Technical Areas		Fault Studies Environment Agency	
GDA Issue Reference	GI-AP1000-CE-04	GDA Issue Action Reference	GI-AP1000-CE-04.A4
GDA Issue Action	<p>Evaluate the effect of borated water from potential leakage from spent fuel pool on mild steel components within CA20.</p> <p>The water within the spent fuel pool and surrounding pools will be more highly borated than standard fuel pools. Corrosion of the mild steel reinforcing bar inside concrete walls and slabs is therefore of concern. Although actions A2 and A3 are aimed at detecting leakage through the secondary barriers comprising RC construction, the effect on the structural integrity must also be evaluated. Westinghouse should provide the following:</p> <ul style="list-style-type: none"> • A best estimate evaluation on the potential corrosion rates of mild steel reinforcing bars within the RC construction to the spent fuel pools and adjacent pools when subject to minor, chronic leaks from the pools. • An evaluation of the effects on the structural capacity of the same RC walls/slabs from the above effects on the rebar. <p>With agreement from the Regulator this action may be completed by alternative means.</p>		

Further explanatory / background information on the GDA Issues for this topic area can be found at:	
GI-AP1000-CE-01 Revision 0	Ref. 63
GI-AP1000-CE-02 Revision 0	Ref. 64
GI-AP1000-CE-03 Revision 0	Ref. 65
GI-AP1000-CE-04 Revision 0	Ref. 66